

---

# INSTALLATION AND OPERATION INSTRUCTIONS WITH REPLACEMENT PARTS LIST

---

## MC5000 Series Controller

Models:

MC5300: Controls up to Three Units

MC5600: Controls up to Six Units



*Climate Control Solutions*

Bard Manufacturing Company, Inc.  
Bryan, Ohio 43506  
[www.bardhvac.com](http://www.bardhvac.com)

Manual: 2100-746J  
Supersedes: 2100-746I  
Date: 7-6-23

# CONTENTS

<b>General Information</b> .....	<b>4</b>	Pre-Purge Sequence of Operation .....	20
Shipping Damage .....	4	Lead/Lag (Rotation) .....	21
General.....	4	Cooling Sequence of Operation .....	21
Theory of Operation.....	4	Heating Sequence of Operation .....	21
Controller Certifications.....	4	Electric Heat.....	21
Getting Other Information and Publications.....	4	Heat Pumps .....	21
Control System.....	5	Humidity Control Option.....	24
Controller and Accessories.....	5	Dehumidification Sequence .....	24
Optional Sensors.....	5	Mechanical Sequence.....	24
<b>Installation</b> .....	<b>6</b>	Synchronized Sequence.....	25
MC5000 Series Controller .....	7	Humidification Operation.....	25
Mounting the MC5000 Series Controller .....	7	Staging.....	25
Installing Remote Temperature Sensor(s) .....	8	Staging Sequence.....	25
<b>Engineered Features</b> .....	<b>9</b>	Heating Staging.....	26
Touch Screen .....	9	Cooling Staging .....	26
Main Control Board (MC5300 and MC5600).....	10	Adjustable Interstage Differential .....	26
Secondary Control Board (MC5600 Only).....	11	Adjustable Off Differential .....	26
Main Alarm Board (MC5300-BC and MC5600-BC) .....	12	Cooling with Economizer .....	26
Secondary Alarm Board (MC5600-BC Only) .....	13	The Advantages of Twinning: Pairs.....	27
<b>Setup</b> .....	<b>14</b>	The Advantages of Twinning: Triples .....	27
Guided Setup.....	14	Humidification/Dehumidification Demand Staging ..	28
MC5000 Equipment Setup Menu Descriptions ..	14	Alternating/Non-Alternating Set Up.....	28
MC5000 Controller System Setup Menu		Alternating/Non-Alternating Logic.....	28
Descriptions .....	14	Alternating.....	28
Equipment Setup Menu.....	14	Non-Alternating .....	28
System Setup Menu.....	15	Twinning: Simultaneous Unit Operation .....	30
Date/Time Setup Menu .....	15	Triples: Simultaneous Unit Operation.....	31
Comfort Mode .....	15	Alarm Functionality.....	32
System Status .....	15	Test Mode .....	34
Cooling Set Points .....	15	Self Test .....	34
Heating Set Points.....	15	Manual Test .....	34
Comfort Mode Cooling Set Points .....	15	Network/Remote Connectivity.....	34
Comfort Mode Heating Set Points.....	16	Remote Connectivity .....	34
Dehumidification Level Set Points.....	16	Setup .....	34
Humidification Level Set Points .....	16	Touch Screen Display IP Configuration .....	34
Cooling Interstage Differential Set Points .....	16	Webpage IP Configuration.....	35
Cooling Stage Off Differential Set Points.....	16	Webpages .....	36
Heating Interstage Differential Set Points.....	16	Navigational Side Pane.....	36
Heating Stage Off Differential Set Points .....	16	Modbus .....	37
Dehumidification Interstage Differential Set Points .....	16	<b>Connections Diagrams</b> .....	<b>42</b>
Dehumidification Stage Off Differential Set Points .....	16	<b>Troubleshooting</b> .....	<b>55</b>
Humidification Interstage Differential Set Points.....	17	Checking Remote (8408-061) or Local Temperature/	
Humidification Stage Off Differential Set Points .....	17	humidity Sensor (8408-059) .....	55
High Humidity Alarm Set Points.....	17	Checking Remote Temperature Sensor 8301-095A .....	56
Low Humidity Alarm Set Points.....	17	Troubleshooting Alarms .....	57
Low Temperature Alarm Level Set Points.....	17	<b>MC5000 Replacement Parts List</b> .....	<b>59</b>
High Temperature Alarm Level 1 Set Points.....	17	<b>FIGURES AND TABLES</b>	
High Temperature Alarm Level 2 Set Points.....	17	Figure 1 .....	6
Heat Pump Lockout Range Set Points.....	17	Figure 2 .....	7
<b>Operation</b> .....	<b>18</b>	Figure 3 .....	8
Basic Controller Specifications/Features.....	18	Figure 4 .....	8
Temperature Sensors.....	18	Optional Remote Temperature Sensor	
Temperature Sensor Logic.....	18	Installation .....	8
Basic Controller Input/Output Specifications .....	19	Figure 5 .....	9
Alarm Board Specifications/Features.....	19	Figure 6 .....	24
MC5000 Alarm Board I/O.....	19	Figure 7 .....	25
Alarm Board Contacts.....	19	Figure 8 .....	26
MC5000B w/Enhanced Version Alarm Board		Figure 9 .....	26
plus MC5000A Inputs/Outputs.....	20	Cooling with Six Single Stage Units	
Low Voltage Field Wiring.....	20	(w/Economizers) .....	26
Controller Grounding .....	20	Figure 10 .....	27
Controller Power-Up .....	20	Cooling with Six Single Stage Units	
Emergency Off.....	20	(w/Economizers) Using Twinning/	
Staging Delay Periods .....	20	Pairs Option.....	27
Blower Operation .....	20	Figure 11 .....	27
Pre-Purge.....	20	Cooling with Six Single Stage Units	
Pre-Purge Setup .....	20	(w/Economizers) Using Twinning/	
		Triples Option .....	27
		Figure 12 .....	29
		Figure 13 .....	29

Figure 14	Twinning: Simultaneous Unit Operation.....	30
Figure 15	Triples: Simultaneous Unit Operation .....	31
Figure 16	Back of Touch Screen Display.....	35
Figure 17	Setup Button on MC5000 Home Screen.....	35
Figure 18	Webpage Navigational Side Panel .....	36
Figure 19	W**A/W**L Series Unit w/CRV-F, ERV and No Ventilation or Balanced Climate.....	43
Figure 20	W**A W**A/W**L Series Unit w/CRV-F, ERV and No Ventilation w/Balanced Climate .....	44
Figure 21	W**A/W**L Series Unit w/Economizer.....	45
Figure 22	W**H Series Unit w/CRV-F, ERV and No Ventilation or Balanced Climate.....	46
Figure 23	W**H Series Unit with CRV-F, ERV and No Ventilation w/Balanced Climate.....	47
Figure 24	W**H Series Unit w/Economizer .....	48
Figure 25	2-Stage W**SA* Series Unit w/CRV-F, ERV, and No Ventilation or Balanced Climate.....	49
Figure 26	2-Stage W**SA* Series Unit w/Balanced Climate and No CRV-F or Ventilation .....	50
Figure 27	2-Stage W**SA* Series Unit w/Economizer ..	51
Figure 28	2-Stage T**S Series Unit w/No CRVMWH-* or CHCRV-* .....	52
Figure 29	2-Stage C**H Series Unit w/No CRVMWH-* or CHCRV-*.....	53
Figure 30	T**H Series Unit w/No CHCRV-* .....	54
Figure 31	Verifying Sensor LED Is Illuminated .....	55
Figure 32	Sufficient Airflow Across Remote Sensor.....	55
Table 1	MC5000 Series Set Points/Defaults/ User Settings Record .....	22
Table 2	Alternating Logic: 3-Unit System with 2 Stage Compressor and Economizer.....	28
Table 3	Non-Alternating Logic: 3-Unit System with 2 Stage Compressor and Economizer.....	28
Table 4	MC5000BC Series Alarm Functions.....	33
Table 5	Default Network Settings .....	34
Table 6	Connection Diagram Selection .....	42
Table 7	10K OHM NTC Sensor: Temp/Resistance.....	56

# IMPORTANT

*The equipment covered in this manual is to be installed by trained, experienced service and installation technicians. Please read the entire manual before proceeding.*

# IMPORTANT

*When connecting this product from a remote location, ensure that the network connection is secure and reliable.*

# NOTICE

*It is important to check the software version during installation to ensure that the latest version has been installed. Current software versions and installation instructions are available on the Bard website at <http://www.bardhvac.com/software-download/>*

## MC5000 Series Controller Nomenclature

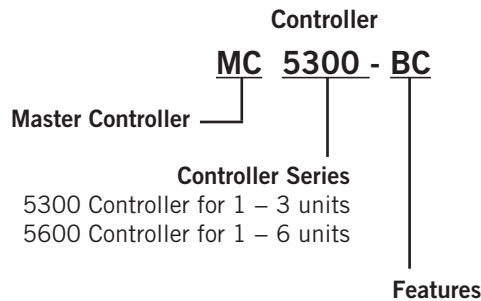

C – Controller with local alarms, Ethernet webpages and Modbus  
 BC – Controller with local alarms, NO/NC remote alarm contacts, Ethernet webpages and Modbus

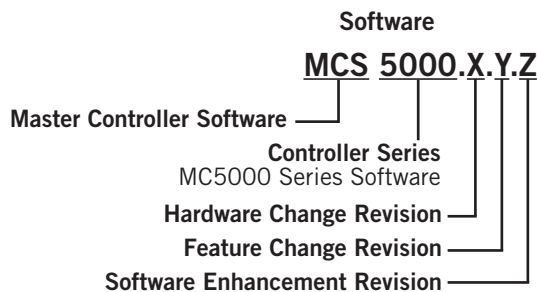

### Software Updates

#### Software Use

The MC Series controllers contain a solid state logic board with on-board software similar to a computer. Software updates, as they become available, will be posted to the following address: [www.bardhvac.com/software-download/](http://www.bardhvac.com/software-download/). Updating software may require the use of an Ethernet cable and/or a MicroSD card.

# GENERAL INFORMATION

## Shipping Damage

Upon receipt of equipment, the cartons should be checked for external signs of shipping damage. If damage is found, the receiving party must contact the last carrier immediately, preferably in writing, requesting inspection by the carrier's agent.

## General

The equipment covered in this manual is to be installed by trained, experienced service and installation technicians. Please read entire manual before proceeding.

While these instructions are intended as a general recommended guide, they do not supersede any national and/or local codes in any way. Authorities having jurisdiction should be consulted before the installation is made. See **Getting Other Information and Publications** for information on codes and standards.

These instructions explain the operation, installation and troubleshooting of the MC5000 series controllers.

All internal wiring is complete. Only attach low voltage field wiring to designated terminal strips.

The MC5000 series is for use with units with or without economizers, can be configured for use with heat pumps and has both humidification and dehumidification control features.

It is recommended that a 5-minute compressor time delay relay be installed in each unit if not so equipped.

The MC5000 series controller is suitable for both 50 and 60 HZ operation, and is fully configurable such that it can be used in virtually any installation. See **Basic Controller Specification/Features** on page 18 for further information.

## Theory of Operation

The controller is used to control up to six wall-mount air conditioners or heat pumps with one control. All models should be the same (humidification and dehumidification options can vary). It can provide total redundancy for the structure and equal wear on units. Units with or without economizers can be used and it is recommended that units be equipped alike.

The MC5000 can be configured for an alternating or non-alternating lead/lag sequence. This allows the user more control on how units will stage on and still allow for even usage.

If the base controller (MC5300-C or MC5600-C) was initially installed, the system can easily be upgraded.

The MC5000 series controller can be equipped with an alarm board that can be factory installed or installed at any time in the field.

Upgrading to a system with alarm boards can be accomplished by installing the boards in the provided screw-in slots and terminals within the controller. The field installation will require the provided snap-in wire harness and building alarm circuitry to be wired to the MC alarm boards.

There is an Ethernet-based remote communication port on the back of the touch screen display (P/N 8612-065) that comes standard with each unit. The Ethernet connection allows for network connectivity and remote control. **IMPORTANT:** *When connecting this product from a remote location, ensure that the network connection is secure and reliable.*

## Controller Certifications

The MC5000 series main display, controller I/O boards, optional alarm boards and remote sensors have undergone extensive UL testing. This system has also undergone immunity and emissions testing and is considered compliant to FCC 47 CFR 15 Subpart B, Class A.



CONFORMS TO UL STD 916  
CERTIFIED TO CSA STD C22.2 NO. 205

### MC5000 Series Master Controller



This device complies with FCC Rule Part 15, Subpart B, Class A. Operation is subject to the following two conditions:

1. This device may not cause harmful interference
2. This device must accept any interference received, including that which may cause undesired operation.

This ISM device also complies with Canadian ICES – 003: 2016.

**Bard Manufacturing Company, Inc.**  
Bryan, OH 43506

## Getting Other Information and Publications

These publications can help when installing the air conditioner or heat pump. They can usually be found at the local library or purchased directly from the publisher. Be sure to consult the current edition of each standard.

Standard for the Installation of Air Conditioning and Ventilating Systems .....ANSI/NFPA 90A

Standard for Warm Air Heating and Air Conditioning Systems .....ANSI/NFPA 90B

For more information, contact these publishers:

**Air Conditioning Contractors of America (ACCA)**

1712 New Hampshire Ave. N.W.  
Washington, DC 20009  
Telephone: (202) 483-9370 Fax: (202) 234-4721

**American National Standards Institute (ANSI)**

11 West Street, 13th Floor  
New York, NY 10036  
Telephone: (212) 642-4900 Fax: (212) 302-1286

**American Society of Heating, Refrigeration and Air Conditioning Engineers, Inc. (ASHRAE)**

1791 Tullie Circle, N.E.  
Atlanta, GA 30329-2305  
Telephone: (404) 636-8400 Fax: (404) 321-5478

**Control System**

This Bard control system can be composed of a variety of non-PLC operated Bard wall-mount air conditioners or heat pump model offerings. The MC5300 controller can be matched with up to a maximum of three wall-mount air conditioners or heat pumps. The MC5600 controller can be matched with up to a maximum of six wall-mount air conditioners or heat pumps.

See Specifications Sheet S3612 for more information on the control system.

**Controller and Accessories**

All MC5000 Series controllers have Ethernet connectivity with local monitoring and diagnostics through the use of the color touch screen. If using alarm boards, they will provide NO/NC contacts as an option. The alarm boards, MC5300-BC Alarm Board (P/N 8612-068A) or MC5600-BC Alarm Boards (P/N 8612-068A and P/N 8612-069), can also be used to connect to a building Network Operations Center (NOC) system using Normally Open and Normally Closed dry contacts.

One onboard temperature/humidity sensor (P/N 8408-059) is included with the controller. **This sensor, or optional**

**remote temperature/humidity sensor w/35' cable (see below), must be used for proper operation.**

The power (24VAC) for the control system comes from the units connected to each system module of the I/O boards. The display is powered through the connection to the main I/O board. Therefore, a separate power supply is not required.

**NOTE:** Bard recommends installation of an optional remote temperature-only sensor (P/N 8301-095A) for redundancy. See **Temperature Sensors** section on page 18 for further information.

**Optional Sensors**

An optional remote temperature/humidity sensor with a 35' cable (P/N 8408-061) can be purchased to replace the factory-installed (local, not expandable) temperature/humidity sensor (P/N 8408-059, with 11" cable). **Only one temperature/humidity sensor can be connected to the controller at any given time.**

The optional temperature/humidity sensor should be remotely mounted in a location that is least likely to be affected by open doors, rack-mounted fans, radiant heat sources, etc. It is recommended that the sensor be mounted using the screw slot located on the sensor housing or be fastened with a zip tie.

Up to two additional remote temperature-only sensors (P/N 8301-095A) with a standard 35' cable can be added to the controller. The additional sensors can be configured for either indoor or outdoor use, with two configuration options: 1.) As one indoor and one outdoor sensor or 2.) both as additional indoor sensors. Sensors are limited to the following use: Remote 1 is for indoor use only and Remote 2 can be configured for either indoor or outdoor use.

Install the temperature sensor(s) in a location least likely to be affected by open doors, rack-mounted fans, radiant heat sources, etc. Locating the sensor between two return grilles is often the best location, but every installation is unique. Location height should be approximately 48" to 60" above the floor. These sensors can be secured with zip ties or any means of fastening. To prevent excessive exposure to water or to keep moisture from accumulating, the sensor should be vertically oriented with the wires being located towards the ground.

**MC5000 Series Controller and Accessories**



MC5000 Series Controller



Indoor Air Temperature/  
Humidity Sensor  
P/N 8408-061



Temperature-Only Sensor  
P/N 8301-095A

# INSTALLATION

**FIGURE 1**  
Typical MC5000 Series Controller Component Location

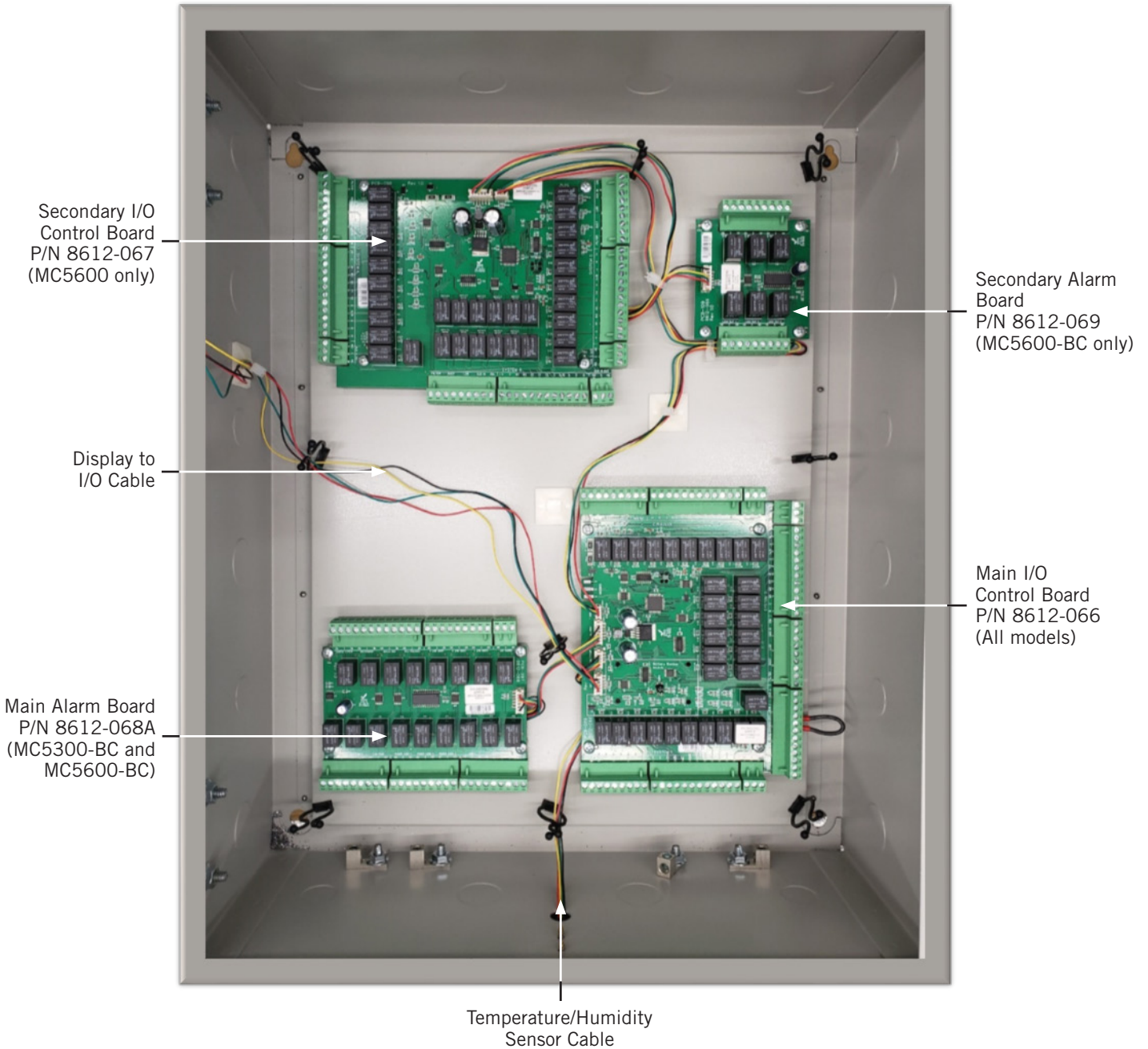

# ⚠ WARNING

**Electrical shock hazard.**

**Disconnect VAC power supplies before servicing.**

**Failure to do so could result in electric shock or death.**

**IMPORTANT:** When working with circuit board components, Bard recommends the use of an anti-static wrist strap to prevent static electricity shorts to electronic controls.

## MC5000 Series Controller

The MC5000 series controller is used to control up to six wall-mount air conditioners or heat pumps. The front display controller provides an easy-to-read interface with a touch screen LED graphical display while providing redundancy for the structure.

Conduit is recommended for all wiring. Route connection wiring in conduit separate from unit wiring and/or high voltage wiring.

The MC5000 series controller is not weatherproof and is intended for use in a weather tight structure.

### Mounting the MC5000 Series Controller

The MC5000 series controller can be installed in any indoor location that has wall space for hanging. It is suggested that the controller be hung at eye level. Four (4) mounting holes are provided for mounting to the wall. Use mounting hardware capable of holding the weight of the controller such as 1/4" diameter fasteners with flat washers that are 1" outside diameter (OD). Knockouts provided on the base, sides and top of the controller can be used for conduit connections (see Figure 2).

The power (24VAC) for the control system comes from the units connected. Therefore, a separate power supply is not required. There are ground lugs located inside on the bottom of the control; an equipment ground is required (see Figure 3 on page 8). Conduit is recommended for control wiring protection.

**FIGURE 2**  
MC5000 Series Controller Dimensional Drawing

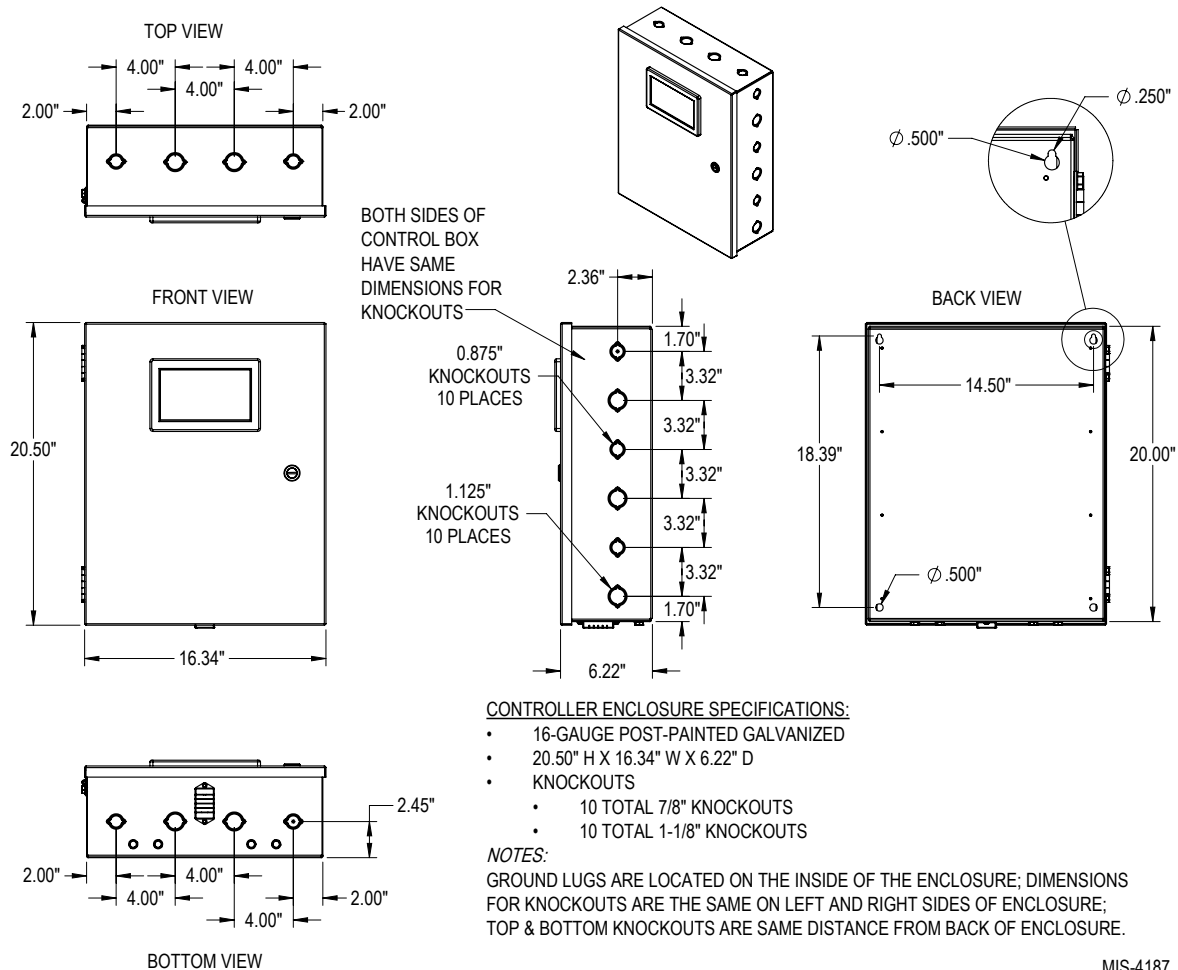

MIS-4187

**FIGURE 3**  
Controller Grounding Lugs

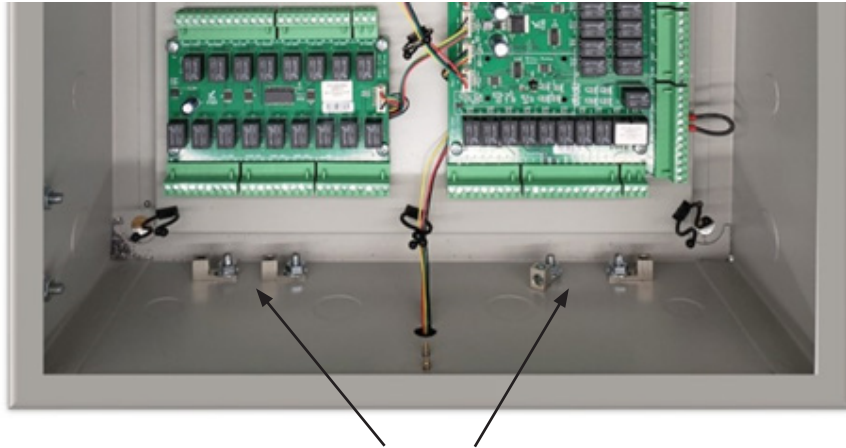

Ground lugs provided on the inside of bottom of the controller enclosure

**Installing Remote Temperature Sensor(s)**

Up to two (2) additional remote temperature sensors can be installed (see Figure 4). Temperature sensor 8301-095A with 35' of 24 gauge 2-conductor shielded cable is available from Bard. This sensor is a 10kΩ NTC sensor. Mount the remote temperature sensor(s) in a location least likely to be affected by open doors, rack-mounted fans, radiant heat sources, etc. Locating

the sensor between both return grilles is often the best location, but every installation is unique. Location height should be approximately 60" above the floor.

The sensor can be utilized as either an indoor or outdoor temperature sensor. REM 1 is to be used only for an additional indoor temperature sensor. REM 2 can be used for an indoor or outdoor sensor and needs to be configured using the touch screen.

**FIGURE 4**  
Optional Remote Temperature Sensor Installation

1. Connect one of the wires from the 24 gauge shielded cable to either the REM 1 or REM 2 terminal on the main I/O board (P/N 8612-066). REM 1 can only be used for an additional indoor temperature sensor. REM 2 can be configured to be used for either an indoor or outdoor sensor application. The connection points are shown below.

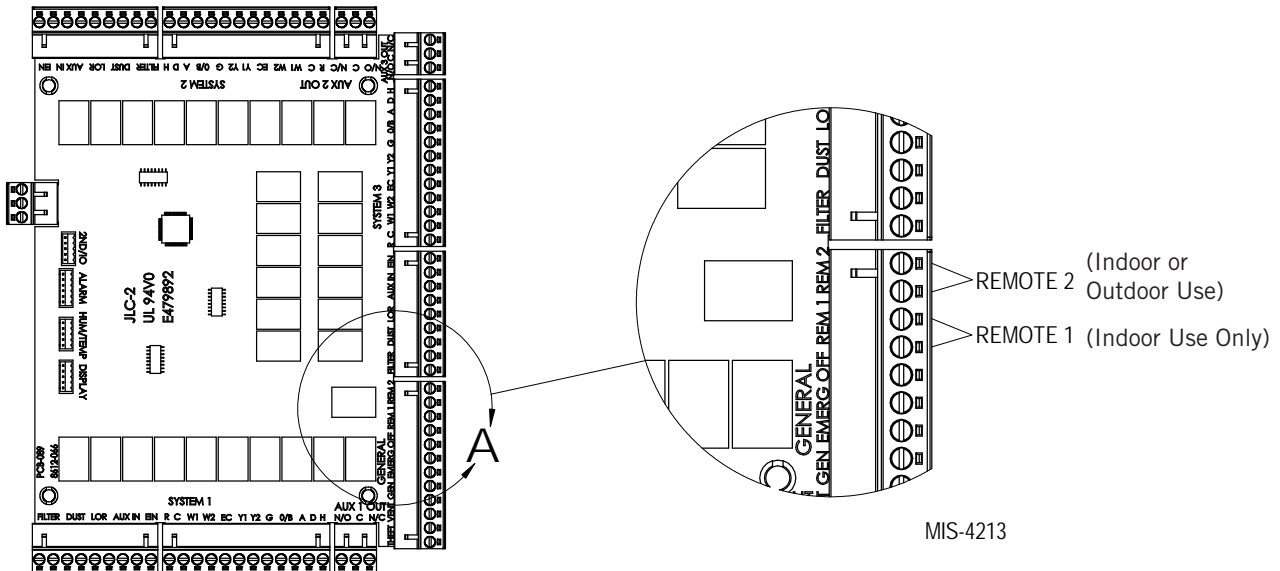

2. Connect the other wire from the sensor to the open terminal associated with the landing point of the previously connected wire. Be sure wires are connected to proper terminals as shown above.



## Touch Screen

The MC5000 series controller incorporates a 6.2" x 3.5" touch screen interface for user interaction (see Figure 5). It is not necessary to use only fingers on this interface as the display will respond to pressure from almost any type of object. If the user is wearing gloves, the interface will still respond to touch. It is important to be cautious about what types of objects are used on the interface as scratching and other types of damage can occur if inappropriate touch devices are used. It is advisable to use only smooth blunt objects and avoid objects with sharp or abrasive surfaces for interaction with the touch screen.

Menus, screens and navigation on the MC5000 series controller are designed to be intuitive and from the Home Screen there is easy access to any menus or information desired.

After a period of 5 minutes of inactivity (no input on the touch screen), the controller will return to the Home Screen. If there has not been input to the touch screen for a period of 10 minutes, the controller will go into sleep mode. To reactivate screen, touch anywhere on the screen to "wake up" the controller.

**NOTE:** When an active alarm is present, screen will stay illuminated.

**FIGURE 5**  
MC5000 Series Touch Screen Interface

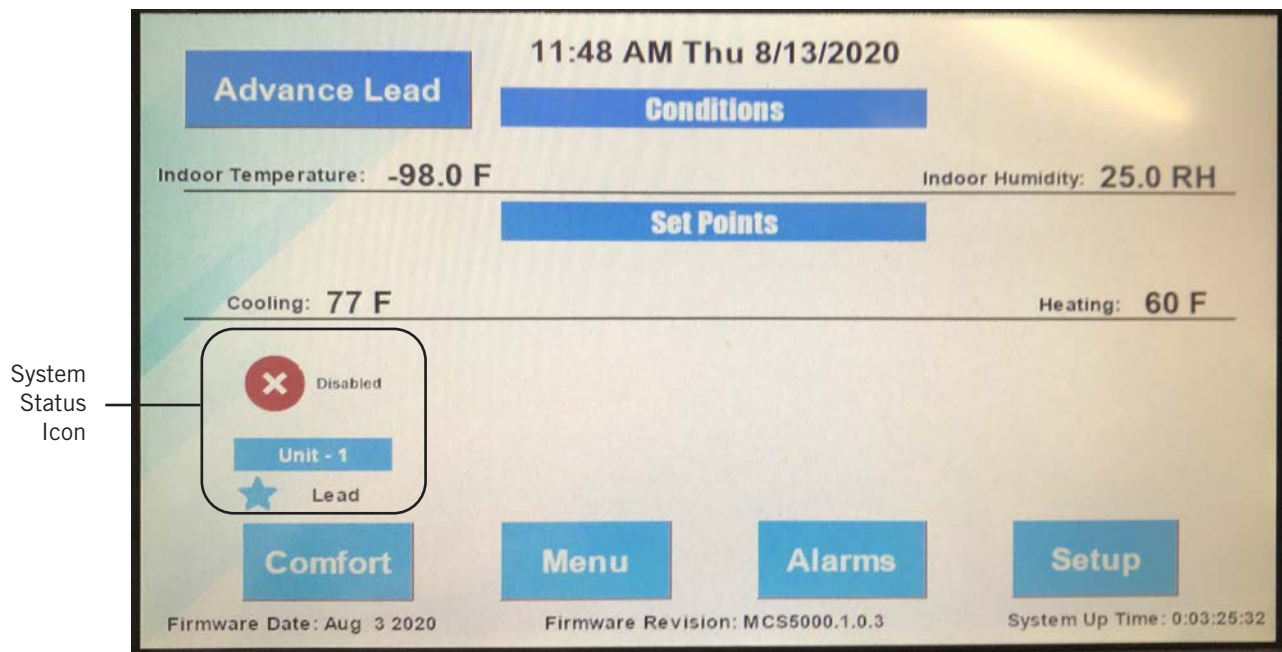

The main controller display (Home Screen) shows the status of all systems connected to the controller, ambient conditions inside the area being conditioned and temperature and humidity set points. System status icon (see Figure 5) indicates the total amount of units connected, if they are in cooling or heating mode, and identifies the lead unit. Ambient conditions including indoor temperature and humidity are displayed. Outdoor temperature is displayed if a field-supplied outdoor sensor is used (outdoor sensor must be wired to REM 2). Set points include heating and cooling set points, and a dehumidification set point for units installed with the ability to run in dehumidification mode (not shown). Touch screen buttons are provided for Comfort (comfort mode), Menu (settings menu), Alarms (active and past alarms) and Setup (setup wizard).

## Main Control Board (All MC5300 and MC5600 Models)

The Main Control Board (P/N 8612-066) has connection points provided for one to three wall-mount air conditioners or heat pumps. Units can include optional mechanical dehumidification, electric heat strips, economizer and ventilation. Inputs are also provided for theft, vent, generator, emergency off and two remote temperature sensors. The shelter inputs (theft, vent, generator, emergency off and remote sensor 1 and 2) are connected to the main control board next to Unit 3 terminal strip.

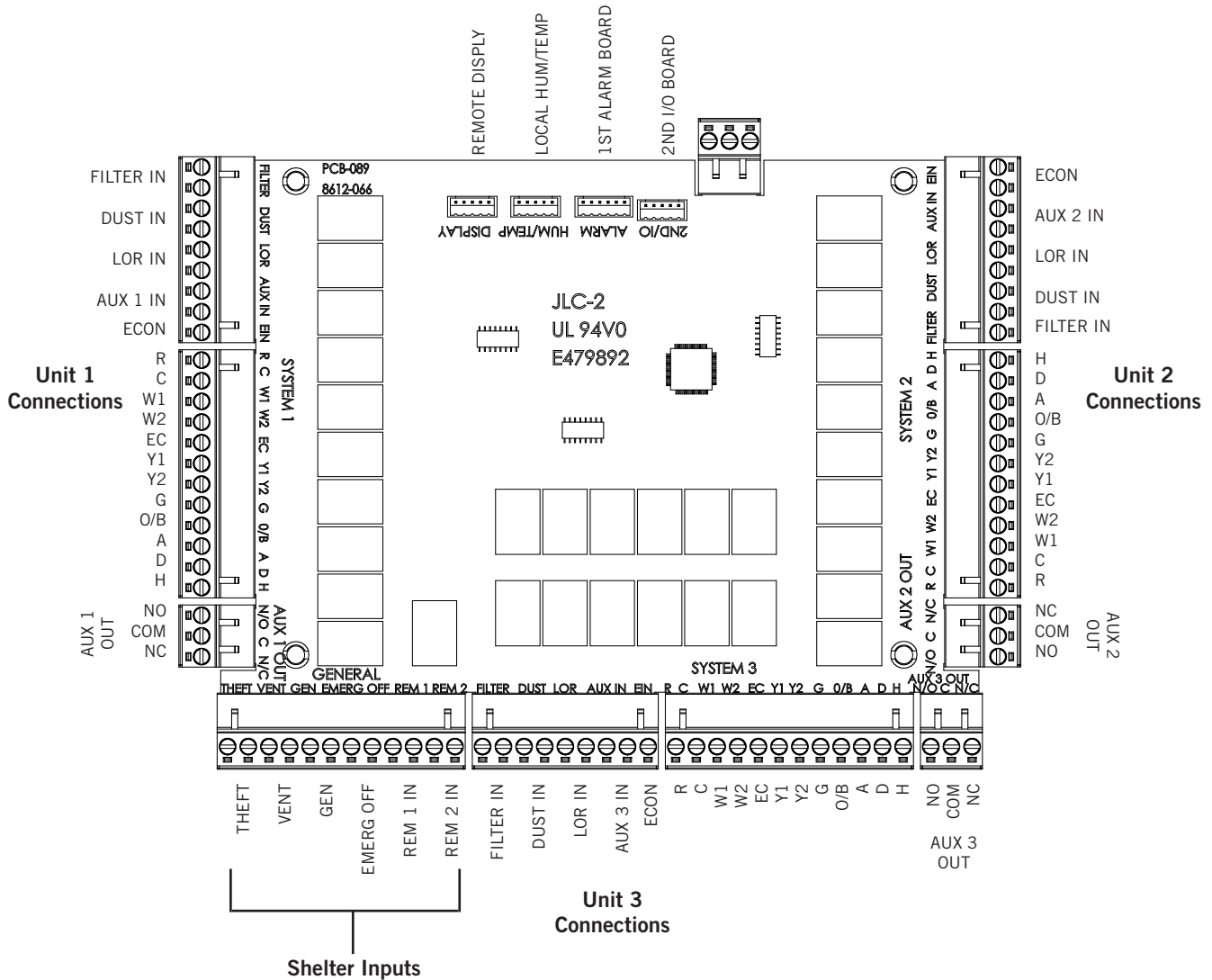

## Secondary Control Board (MC5600-C and MC5600-BC Models Only)

The Secondary Control Board (P/N 8612-067) provides connection points for up to three additional wall-mount air conditioners or heat pump units labeled System 4, 5 and 6. All units can include optional mechanical dehumidification, electric heat strips, economizer and ventilation.

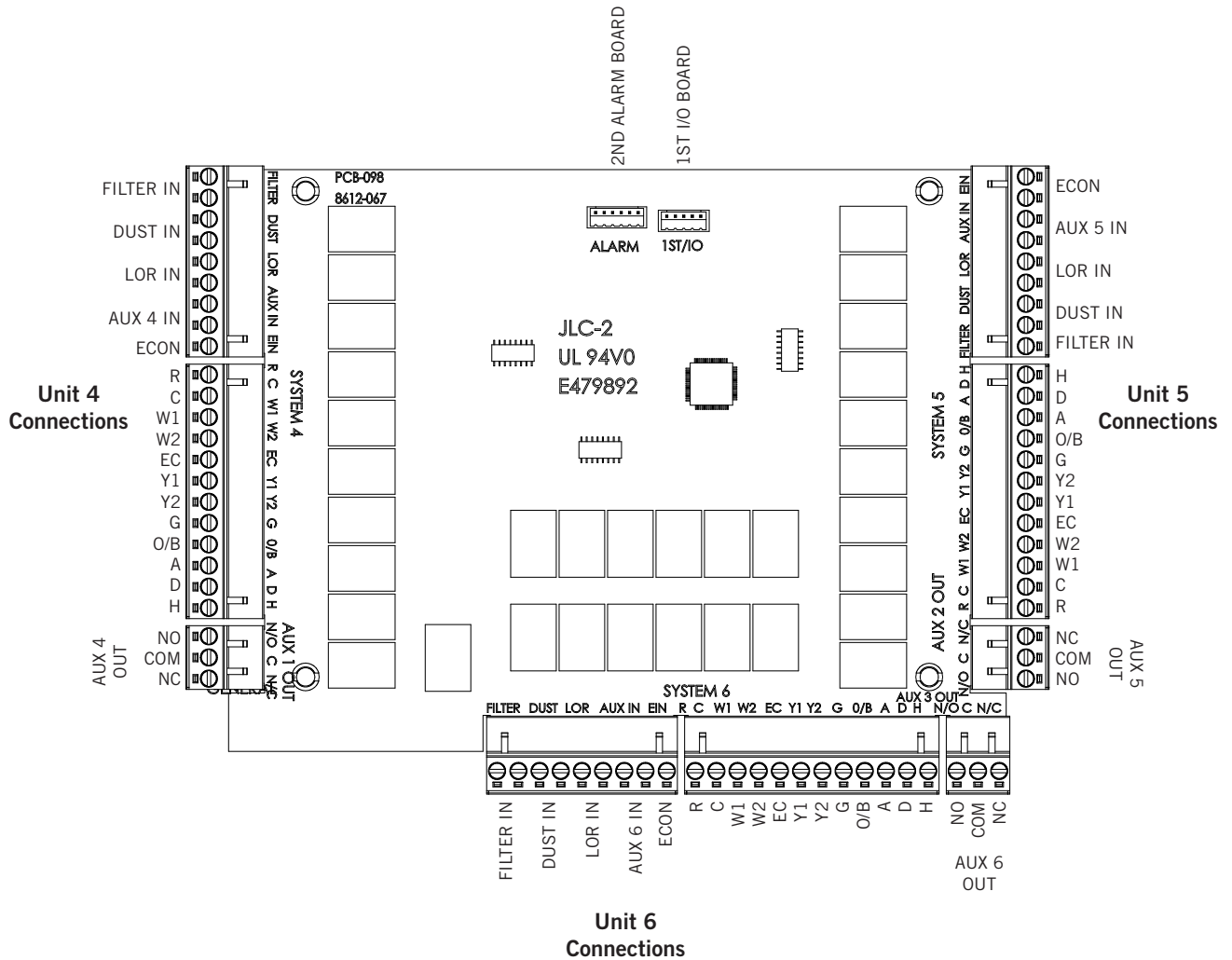

## Main Alarm Board (MC5300-BC and MC5600-BC Models Only)

The Main Alarm Board (P/N 8612-068A) allows for Normally Open or Normally Closed dry contacts to be used for remote monitoring of equipment and the controller. The Main Alarm Board will be used only with either the MC5300-BC or MC5600-BC models to monitor alarms for Systems 1, 2 and 3.

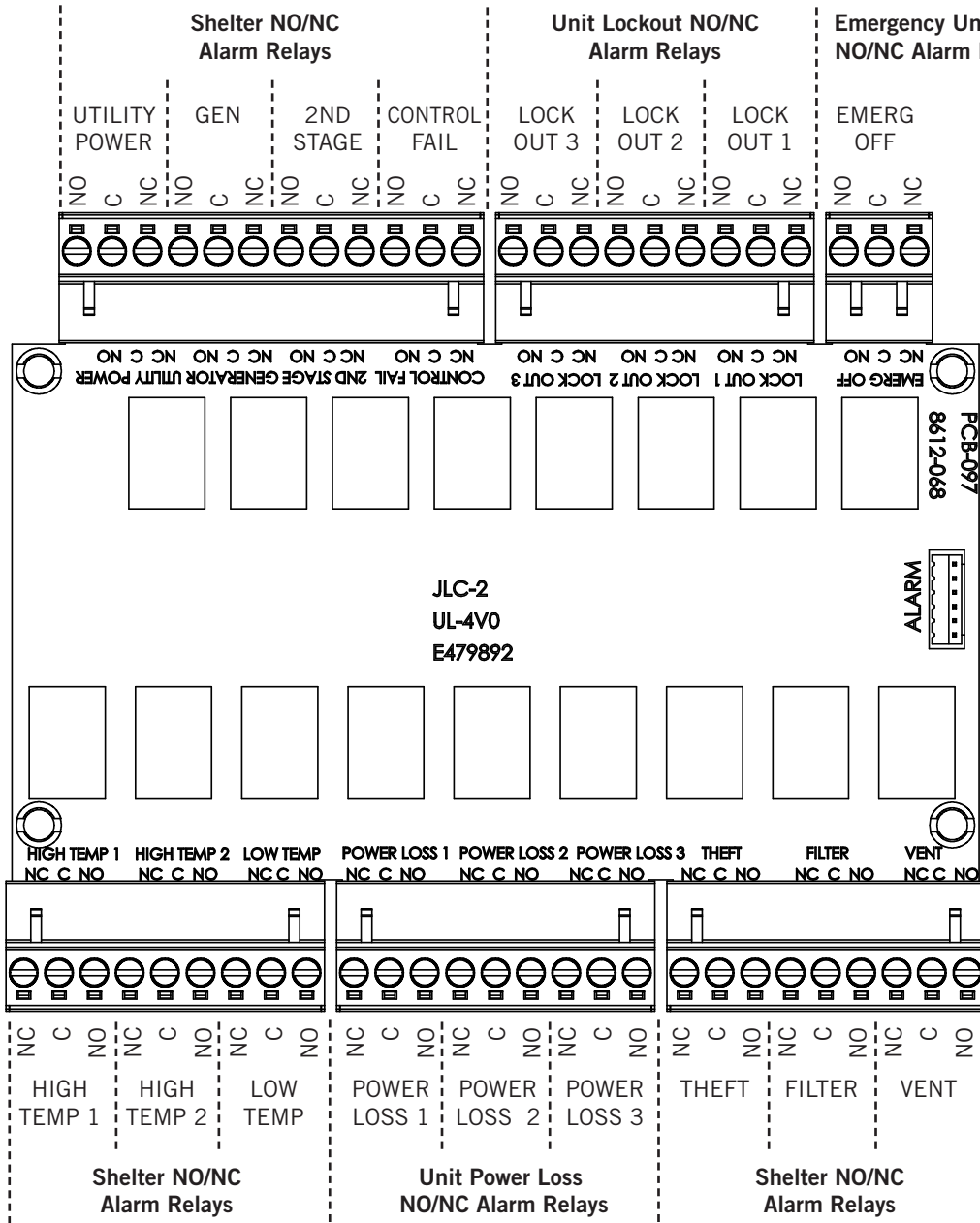

## Secondary Alarm Board (MC5600-BC Models Only)

The Secondary Alarm Board (P/N 8612-069) allows for Normally Open or Normally Closed dry contacts to be used for remote monitoring of equipment and the controller. The Secondary Alarm Board will be used only with the MC5600-BC models to monitor alarms for Systems 4, 5 and 6.

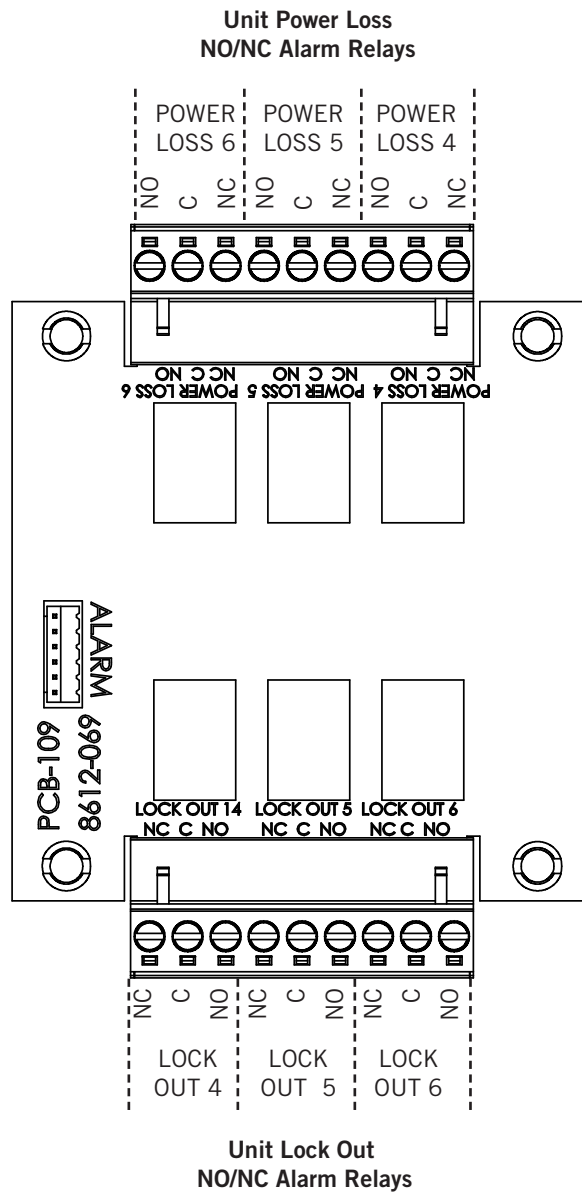

# SETUP

---

## Guided Set Up

The MC5300/5600 controller includes a guided set up feature with two main components, the Equipment and System Set Up menus. Each screen progresses through the menus and will build on the last to configure either the equipment connected to the controller or the controller features to be used/configured. The descriptions of the menu options and menu setups are outlined below:

### MC5000 Equipment Setup Menu Descriptions

1. Number of HVAC Systems: 1 – 6  
Determines the number of units connected to the controller, backbone for staging availability and feature limitations.
2. Number of Compressor Stages: 1 or 2  
Determines number of stages and if Y2 is to be used.
3. Are Units Heat Pumps?: Yes or No  
Determines if the units connected to the controller are heat pumps.
4. Energize O/B During Cooling or Heating: Cooling or Heating  
Determines configuration of the O/B terminal (energized in cooling or heating). **NOTE: All Bard wall-mount heat pumps require the reversing valve to energize in HEATING mode.**
5. Number of Electric Heat Stages: 0, 1 or 2  
Determines number of stages to be considered and if W2 terminal is to be used.
6. Dehumidifier Type: None, Synchronized or Mechanical  
If Synchronized is selected, the “D” terminal is not used and units will use Synchronized sequence (see page 25 for information on Synchronized Dehumidification). If Mechanical is selected, the D terminal will be energized for Dehum operation according to Mechanical sequence. If None is selected, the following step (Number of Dehumidifier Units) is skipped.
7. Number of Dehumidifier Units: Choice limited to number of HVAC systems  
Sets the number of units equipped with dehumidification.
8. Humidifier Present: Yes or No  
If H is to be used, the number of dehumidification units selected in the setup menu (see #7) will be the number of units configured for humidification.

9. Auxiliary Output Configuration: Configure  
AUX terminal can be configured to provide a contact change for each of the following conditions if individually selected: Emergency Off Alarm, Generator Run Alarm, High Humidity Alarm, Dust Alarm or Dehumidification Active.

### MC5000 System Setup Menu Descriptions (default indicated in bold)

1. Language – **English**, French or Spanish
2. Password Protection – User can configure password here (**No**)
3. Twinning Staging Logic – **Off**, All or Pairs
4. Staging Logic – **Alternating** or non-alternating
5. Lead-Lag Change Over Time – Time setting 0-30 days (**7**)
6. Continuous Blower Logic – Lead, **None**, All, Prepurge or Custom
7. Degrees – **Fahrenheit** or Celsius
8. Temperature Sensor Logic – **Average**, highest or lowest
9. REM 1 Temperature Sensor – Indoor Temperature or **Not Connected**
10. REM 2 Temperature Sensor – Indoor Temperature, Outdoor Temperature or **Not Connected**
11. Equipment Minimum Run Time – 0-5 minutes (**3**)
12. Maximum Number of Units While in Generator Mode – Choice limited to number of HVAC systems (**1**).
13. Touch Screen Display Brightness – 10-100% (**80**)

### Equipment Setup Menu

1. Press Setup button on Home screen.
2. Press Equipment Setup button.
3. Press UP/DOWN buttons to scroll to enter number of HVAC systems; press Next button.
4. Press 1 or 2 button to enter number of compressor stages; press Next button.
5. Press Yes/No button to select if units are heat pump units or not; press Next button.
6. Press Cooling or Heating button to select whether to energize O/B during cooling or heating; press Next button.
7. Press 2, 1 or 0 button for the number of electric heat stages; press Next button.
8. Press None, Synchronized or Mechanical button for dehumidifier type; press Next button.

9. Press UP/DOWN buttons to scroll to number of dehumidifier units; press Next button.
10. Press Yes or No button to select if humidifier is present; press Next button.
11. Press Configure to configure any of the following: Emergency Off alarm, Generator Run alarm, High Humidity alarm, Dust Alarm, Dehumidification Active. Press Next or Home button.

## **System Setup Menu**

1. Press Setup button on Home screen.
2. Press System Setup button.
3. Press preferred language button; press Next button.
4. Press Yes button if password protection is desired; if Yes is selected, a prompt will appear to enter a PIN number. Press Next button.
5. Press button to select twinning staging logic choice; press Next button.
6. Press button to select staging logic choice; press Next button.
7. Press UP/DOWN buttons to select lead-lag change over time; press Next button.
8. Press button to select continuous blower logic choice; press Next button.
9. Press button to select degrees choice (Fahrenheit/Celsius); press Next button.
10. Press button to select temperature sensor logic choice; press Next button.
11. Press button to select REM 1 temperature sensor choice; press Next button.
12. Press button to select REM 2 temperature sensor choice; press Next button.
13. Press UP/DOWN buttons to select equipment minimum run time; press Next button.
14. Press UP/DOWN buttons to select maximum number of units while in generator mode; press Next button.
15. Press UP/DOWN buttons to select touch screen display brightness; press Next or Home button.

## **Date/Time Setup Menu**

1. Press Setup button on Home screen.
2. Press Date/Time Setup button.
3. Press UP/DOWN arrow to select Hour.
4. Press UP/DOWN arrow to select Minute.
5. Press UP/DOWN arrow to select AM/PM.
6. Press Next button.

7. Press UP/DOWN arrow to select Month.
8. Press UP/DOWN arrow to select Day.
9. Press UP/DOWN arrow to select Year.
10. Press Next button.
11. Press Home button.

## **Comfort Mode**

1. Press Comfort button on Home screen to engage; Comfort Mode Active message will appear on Home screen. Press Comfort button again to disengage.

## **System Status**

1. Press Menu button on Home screen.
2. Press System Status button.
3. Press back button.
4. Press Home button.

## **Cooling Set Points**

1. Press Menu button on Home screen.
2. Press Set Points button.
3. Press UP/DOWN arrow to scroll to Cooling Set Point.
4. Press UP/DOWN arrow to scroll to Cooling Set Point Value.
5. Press Confirm button.
6. Press Home button.

## **Heating Set Points**

1. Press Menu button on Home screen.
2. Press Set Points button.
3. Press UP/DOWN arrow to scroll to Heating Set Point.
4. Press UP/DOWN arrow to scroll to Heating Set Point Value
5. Press Confirm button.
6. Press Home button.

## **Comfort Mode Cooling Set Points**

1. Press Menu button on Home screen.
2. Press Set Points button.
3. Press UP/DOWN arrow to scroll to Comfort Mode Cooling Set Point.
4. Press UP/DOWN arrow to scroll to Comfort Mode Cooling Set Point Value.
5. Press Confirm button.
6. Press Home button.

### **Comfort Mode Heating Set Points**

1. Press Menu button on Home screen.
2. Press Set Points button.
3. Press UP/DOWN arrow to scroll to Comfort Mode Heating Set Point.
4. Press UP/DOWN arrow to scroll to Comfort Mode Heating Set Point Value.
5. Press Confirm button.
6. Press Home button.

### **Dehumidification Level Set Points**

1. Press Menu button on Home screen.
2. Press Set Points button.
3. Press UP/DOWN arrow to scroll to Dehumidification Level.
4. Press UP/DOWN arrow to scroll to Dehumidification Level Set Point Value.
5. Press Confirm button.
6. Press Home button.

### **Humidification Level Set Points**

1. Press Menu button on Home screen.
2. Press Set Points button.
3. Press UP/DOWN arrow to scroll to Humidification Level.
4. Press UP/DOWN arrow to scroll to Humidification Level Set Point Value.
5. Press Confirm button.
6. Press Home button.

### **Cooling Interstage Differential Set Points**

1. Press Menu button on Home screen.
2. Press Set Points button.
3. Press UP/DOWN arrow to scroll to Cooling Interstage Differential.
4. Press UP/DOWN arrow to scroll to Cooling Interstage Differential Set Point Value.
5. Press Confirm button.
6. Press Home button.

### **Cooling Stage Off Differential Set Points**

1. Press Menu button on Home screen.
2. Press Set Points button.
3. Press UP/DOWN arrow to scroll to Cooling Stage Off Differential.

4. Press UP/DOWN arrow to scroll to Cooling Stage Off Differential Set Point Value.
5. Press Confirm button.
6. Press Home button.

### **Heating Interstage Differential Set Points**

1. Press Menu button on Home screen.
2. Press Set Points button.
3. Press UP/DOWN arrow to scroll to Heating Interstage Differential.
4. Press UP/DOWN arrow to scroll to Heating Interstage Differential Set Point Value.
5. Press Confirm button.
6. Press Home button.

### **Heating Stage Off Differential Set Points**

1. Press Menu button on Home screen.
2. Press Set Points button.
3. Press UP/DOWN arrow to scroll to Heating Stage Off Differential.
4. Press UP/DOWN arrow to scroll to Heating Stage Off Differential Set Point Value.
5. Press Confirm button.
6. Press Home button.

### **Dehumidification Interstage Differential Set Points**

1. Press Menu button on Home screen.
2. Press Set Points button.
3. Press UP/DOWN arrow to scroll to Dehumidification ISD.
4. Press UP/DOWN arrow to scroll to Dehumidification ISD Set Point Value.
5. Press Confirm button.
6. Press Home button.

### **Dehumidification Stage Off Differential Set Points**

1. Press Menu button on Home screen.
2. Press Set Points button.
3. Press UP/DOWN arrow to scroll to Dehum Stage Off Differential.
4. Press UP/DOWN arrow to scroll to Dehum Stage Off Differential Set Point Value.
5. Press Confirm button.
6. Press Home button.



### **Humidification Interstage Differential Set Points**

1. Press Menu button on Home screen.
2. Press Set Points button.
3. Press UP/DOWN arrow to scroll to Humidification ISD.
4. Press UP/DOWN arrow to scroll to Humidification ISD Set Point Value.
5. Press Confirm button.
6. Press Home button.

### **Humidification Stage Off Differential Set Points**

1. Press Menu button on Home screen.
2. Press Set Points button.
3. Press UP/DOWN arrow to scroll to Hum Stage Off Differential.
4. Press UP/DOWN arrow to scroll to Hum Stage Off Differential Set Point Value.
5. Press Confirm button.
6. Press Home button.

### **High Humidity Alarm Set Points**

1. Press Menu button on Home screen.
2. Press Set Points button.
3. Press UP/DOWN arrow to scroll to High Humidity Alarm Set Point.
4. Press UP/DOWN arrow to scroll to High Humidity Alarm Set Point Value.
5. Press Confirm button.
6. Press Home button.

### **Low Humidity Alarm Set Points**

1. Press Menu button on Home screen.
2. Press Set Points button.
3. Press UP/DOWN arrow to scroll to Low Humidity Alarm Set Point.
4. Press UP/DOWN arrow to scroll to Low Humidity Alarm Set Point Value.
5. Press Confirm button.
6. Press Home button.

### **Low Temperature Alarm Level Set Points**

1. Press Menu button on Home screen.
2. Press Set Points button.
3. Press UP/DOWN arrow to scroll to Low Temperature Alarm Level.
4. Press UP/DOWN arrow to scroll to Low Temperature Alarm Level Set Point Value.
5. Press Confirm button.
6. Press Home button.

### **High Temperature Alarm Level 1 Set Points**

1. Press Menu button on Home screen.
2. Press Set Points button.
3. Press UP/DOWN arrow to scroll to High Temperature Alarm Level 1.
4. Press UP/DOWN arrow to scroll to High Temperature Alarm Level Set Point Value.
5. Press Confirm button.
6. Press Home button.

### **High Temperature Alarm Level 2 Set Points**

1. Press Menu button on Home screen.
2. Press Set Points button.
3. Press UP/DOWN arrow to scroll to High Temperature Alarm Level 2.
4. Press UP/DOWN arrow to scroll to High Temperature Alarm Level Set Point Value.
5. Press Confirm button.
6. Press Home button.

### **Heat Pump Lockout Range Set Points**

1. Press Menu button on Home screen.
2. Press Set Points button.
3. Press UP/DOWN arrow to scroll to Heat Pump Lockout Range.
4. Press UP/DOWN buttons to scroll to Heat Pump Lockout Range Set Point Value.
5. Press Confirm button.
6. Press Home button.

# OPERATION

---

## Basic Controller Specifications/ Features

- Input power: 18-32 VAC, 60/50Hz, power is supplied from A/C #1 and/or A/C #2, etc., through all units. If one unit loses power, the next unit powers the system.
- Full color touch screen display
- Temperature display: Fahrenheit or Celsius
- HVAC outputs: Form A (NO) relays (2A @ 24 VAC)
- Cooling control stages: Varies by option and number of units.
- Dehumidification circuit: User selectable. For Synchronized Dehumidification, it is selected in pairs 2, 4, 6. For mechanical HGR systems, from one to six can be selected.
- Operating temperature range: -4°F to 155°F (-20 to 68°C)
- Storage temperature range: -22 to 160°F (-30 to 71°C)
- Temperature accuracy: +/- 1°F from 60-85°F (16-30°C); +/- 1% outside 60-85°F
- Lead/lag changeover time: 0 to 30 days
- Timing accuracy: +/- 1%
- Interstage time delay: 5 seconds between stages
- Interstage differential: .5°F to 5°F
- Cooling set point range: 64 to 90°F
- Comfort setting: Cooling 72°F (22°C), heating 68°F (20°C), for 1 hour
- Deadband (difference between cooling and heating set points): 4°F + ISD
- Emergency Off interface: Standard NC circuit jumper, remove for connection to building system control, shuts down outputs to all units immediately, configurable for NC or NO input.
- Memory: EEPROM for set point and changeable parameters (maintains settings on power loss)
- Space temperature sensors: One (1) local temperature/humidity sensor (11") is standard with all models. If temperature/humidity sensor placement requires more distance, an optional 35' temperature/humidity sensor (P/N 8408-061) is available. The MC5000 will also accept up to two (2) optional 35' remote temperature-only sensors (P/N 8301-095A). When multiple sensors are used, temperatures are averaged by default.

- Outdoor temperature sensor: One (1) remote temperature sensor can be added for outdoor temperature sensing. The outdoor sensor is a 35' remote temperature-only sensor (P/N 8301-095A). The sensor is attached on the main I/O board to the REM 2 terminals. If using the remote sensor for outdoor temperature, it must be utilized if the heat pump lockout option is being used.
- Controller enclosure: 16-gauge post-painted galvanized, 16" W x 22" H x 6" D, hinged cover, twenty (20) various sized electrical knockouts.
- System status is displayed on the color touchpad.
- The system is set up and accessed through the use of the touchpad.

## Temperature Sensors

One (1) standard (local) temperature/humidity sensor with 11" cable comes installed from the factory. An optional temperature/humidity sensor with 35' cable (P/N 8408-061) is available that can be remotely mounted. **Only one temperature/humidity sensor can be connected to the controller at any given time.**

The controller is designed to accept one or two additional optional temperature-only sensors. The Bard part number for the optional temperature-only sensor is 8301-095A. The temperature-only sensors come with 35' cable. They can be installed as required in the structure to address hot spots, barriers to airflow, etc. The local sensor remains active, even with the additional optional remote sensors being used.

It is recommended that the sensor lead wires be installed in conduit for protective purposes.

**NOTE:** Bard recommends adding at least one remote sensor for redundancy. If either sensor fails, the other will take over.

**NOTE:** 8301-095A temperature-only sensors are not polarity sensitive.

See page 5 for additional information on optional sensors.

## Temperature Sensor Logic

The standard local sensor monitors the temperature and humidity at the controller location. If this is the only sensor connected, the sensor will control the temperature and humidity of the conditioned space (building).

If one or more additional remote sensors are installed and configured (Rem 1 or Rem 2), the temperature will be controlled to an average (default) of all connected sensors (highest or lowest are options). The controller can be configured to be governed by the hottest sensor for cooling and the coldest sensor for heating.

## Basic Controller Input/Output Specifications

(located on main controller board—units 1-3 and secondary control board—units 4-6)

### Each Unit Outputs

R – 24VAC hot  
C – 24VAC common  
W1 – Heat  
W2 – 2nd stage electric heat  
EC - *Unused*  
Y1 – 1st-stage cool  
Y2 – 2nd-stage cool  
G – Fan  
O/B – Heat pump reversing valve  
A – Ventilation  
D – Dehumidification  
H – Output for humidifier relay

### General Inputs

Emergency Off Input	Shipped with jumper installed. Changing state of input disables all units. Loss of continuity between terminals triggers alarm.
Local	Main temperature/humidity sensor
Rem 1	Optional remote indoor temperature sensor
Rem 2	Optional remote indoor or outdoor sensor
Gen Run Input	Generator interface. Contact closure (continuity) triggers alarm.
Theft Input	Theft (Bard Guard) input. Contact closure (continuity) triggers alarm.
Vent Input	Ventilation input. Contact closure (continuity) triggers alarm.
Filter Input	Dirty filter input. Contact closure (continuity) triggers alarm.
Dust Input	Dust sensor input. Contact closure (continuity) triggers alarm.
LOR Input	Alarm relay input. Contact closure (continuity) triggers alarm.
ECON	<i>Unused</i>
AUX 1-6 IN	<i>Unused</i>

## Alarm Board Specifications/Features

### MC5000 Alarm Board I/O

**NOTE:** *If this alarm board was not originally factory installed, it can be field installed at any time. The Bard part number for the MC5300 alarm board is 8612-068A. The Bard part number for the MC5600 alarm board is 8612-069.*

*Update kits are available as follows:*

8620-321 *Main Alarm Board Upgrade Kit (includes P/N 8612-068A)*

8620-322 *Secondary I/O Board Upgrade Kit (includes P/N 8612-067)*

8620-323 *Secondary Alarm Board Upgrade Kit (includes P/N 8612-069)*

**NOTE:** *All alarm and output relays are dry contacts with ratings up to 1A @ 30 VDC or 1A @ 125 VAC.*

**NOTE:** *All alarm relay outputs have 5-second delay before issuing to protect against nuisance alarm signals.*

### Alarm Board Contacts

#### Alarm Board 1 Outputs

- UTILITY POWER (Relay Output NO, NC)
- GENERATOR (Relay Output NO, NC)
- 2ND STAGE (Relay Output NO, NC)
- CONTROL FAIL (Relay Output NO, NC)
- LOCK OUT 3 (Relay Output NO, NC)
- LOCK OUT 2 (Relay Output NO, NC)
- LOCK OUT 1 (Relay Output NO, NC)
- EMERG OFF (Relay Output NO, NC)
- HIGH TEMP 1 (Relay Output NO, NC)
- HIGH TEMP 2 (Relay Output NO, NC)
- LOW TEMP (Relay Output NO, NC)
- POWER LOSS 1 (Relay Output NO, NC)
- POWER LOSS 2 (Relay Output NO, NC)
- POWER LOSS 3 (Relay Output NO, NC)
- THEFT (Relay Output NO, NC)
- FILTER (Relay Output NO, NC)
- VENT (Relay Output NO, NC)

#### Alarm Board 2 Outputs

- POWER LOSS 6 (Relay Output NO, NC)
- POWER LOSS 5 (Relay Output NO, NC)
- POWER LOSS 4 (Relay Output NO, NC)
- LOCK OUT 4 (Relay Output NO, NC)
- LOCK OUT 5 (Relay Output NO, NC)
- LOCK OUT 6 (Relay Output NO, NC)

## **MC5000-B w/Enhanced Version Alarm Board (Additional Outputs) plus MC5000-A Inputs/Outputs**

Alarm relays can be wired for NO (close on alarm) or NC (open on alarm) strategy. Alarm relays can be used individually if there are enough available building alarm points, or can be arranged into smaller groups or even a single group so that all alarm capabilities can be utilized. When multiple alarms are grouped together and issued as a single alarm, there will be no off-site indication of which specific problem may have occurred, only that one of the alarms in the group has been triggered. The individual alarm problem will be displayed on the LED display on face of the controller.

## **Low Voltage Field Wiring**

The MC5000 series controller is powered from the HVAC units that it is controlling, 24 VAC (18-32V) low voltage only (main I/O board).

Circuitry in the MC5000 isolates the power supplies of the air conditioners so that no back feeds or phasing problems can occur. Additionally, if one air conditioner loses power, the MC5000 and the other air conditioners are unaffected and will continue to operate normally.

Connect the low voltage field wiring from each unit per the low voltage field wiring diagrams found in the Connection Diagrams section beginning on page 43. For low voltage wiring, an 18 gauge stranded copper wire, color-coded cable is recommended. **NOTE:** A minimum of 22-gauge control wiring should be used.

## **Controller Grounding**

A reliable earth ground must be connected in addition to any grounding from conduit. Grounding lugs are supplied for this purpose and located inside at the bottom of the panel (see Figure 3 on page 8).

## **Controller Power-Up**

Whenever power is first applied to the controller, there is approximately a 20-second time delay prior to any function) becoming active. There is a 10-second delay between all stages; even if the control is powered up to a warm shelter and the temperature is above several set points, there would still be a delay of 5 seconds between each stage preventing excessive amp draw at power-up.

## **Emergency Off**

To disable the MC5000 series controller and shut down all air conditioners/heat pumps, terminals marked Emergency Off must be used. These terminals must be jumpered together for normal operation. A normally closed (NC) set of dry contacts may be connected across the terminals and the factory jumper removed for use with a field-installed fire suppression system. The contacts will open if Emergency Off input is detected.

## **Staging Delay Periods**

The following delays are built in for both cooling and heating:

### **Stage 1**

0 seconds for blower (if not already on as continuous)  
5 seconds for cooling or heating output

### **All Stages**

The unit blower is called on with the first stage of any unit unless “pre-purge” or continuous run is selected in the System Setup options and the blower is already running.

## **Blower Operation**

The controller can be configured to have main HVAC blowers cycle on and off on demand, have all blowers run continuously, have the lead unit blower run continuously or individual blowers can be selected for continuous run by selecting the “Custom” option in “System Setup” program and choosing the unit numbers. Default setting is the blower(s) start and stop on demand.

## **Pre-Purge**

This feature allows the user to circulate the air in the space to be conditioned to combat stratification and allow for a more accurate measurement of space conditions before activating the initial call for cooling or heating. Circulation time will be selectable by user (1 to 5 minutes in one minute increments). If selected, pre-purge will be functional on initial call for cooling, heating, dehumidification and humidification operation. **Pre-purge will run all available blowers for the user selected time.**

### **Pre-Purge Setup**

Under the System Setup tab and on the Continuous Blower menu, select Pre-purge; a pop-up screen will provide instructions for the setup.

1. Option to Enable/Disable.
2. Selectable time option (1 to 5 minutes in one minute increments).

### **Pre-Purge Sequence of Operation**

When enabled, pre-purge will respond to a heating or cooling call by running the blower of all configured units for the time selected before staging on the conditioning equipment. During this time, if either the temperature moves more than 5° (heating or cooling) or the humidity moves more than 5% (humidification or dehumidification) beyond the respective set points, the controller will exit pre-purge and stage units.

## Lead/Lag Rotation

Pressing the Advance Lead button on the home screen will cause the lead to advance to the next unit. This may be useful during service and maintenance procedures.

Lead unit will be determined by an internal timer and Lead-Lag Changeover Time selected by user. The Lead-Lag Changeover Time will be configurable with a range of 1 to 30 days and can be disabled by setting duration to 0 for an overall range of 0 to 30. Default setting for Lead-Lag will be 7 days. Lead unit will rotate after Lead-Lag Changeover Time expires. At expiration, the lead unit will rotate to the next available unit (Example: 1 to 2) and once the last address used expires the lead unit will restart at unit 1. Lead-Lag configuration will apply to both heating and cooling. If disabled by setting to 0, the lead unit will only rotate manually by utilizing the Advance Lead button. Humidification and dehumidification will not rotate lead. The lead unit will always be unit 1. This will allow users to mix dehum and non-dehum units in a single application. (Dehum units will need to be placed in the lowest unit address locations, i.e., unit 1 will always be the first dehum unit when installed for use with the MC5300/5600.) Number of units used for Lead-Lag will be determined by user configurable setting in the Setup Menu.

When Lead-Lag Changeover Time expires and lead unit is shifted, the call will be satisfied and then the lead unit will rotate. If the Advance Lead button is used to rotate the lead unit, the call will end, the lead unit will be shifted and units will restage in accordance with the demand.

## Cooling Sequence of Operation

The controller will utilize Y1 and Y2 to control cooling for each configured unit. If the units are configured for single stage cooling, Y1 will be energized for cooling and Y2 will not be used. If the units are configured for 2 stage cooling, Y1 will be energized for the first stage and Y2 will be energized for the second stage for each configured unit. Each terminal energized per unit will count as a single stage for cooling staging logic. Cooling stages may be either economizer or mechanical cooling depending upon the unit's configuration.

## Heating Sequence of Operation

### Electric Heat

The controller will use the W1 and W2 terminals to control conventional heating operation for each configured unit. If units are configured for single stage electric heat then W1 will be energized at each configured unit and W2 will not be used. If units are configured for 2 stage electric heat then W1 will be energized first and W2 will be energized for an additional stage of electric heat at each configured unit. Each terminal energized will count as a single

stage for staging logic. If units are configured for heat pump operation in conjunction with electric heat, the electric heat (W1 & W2) will be added as additional stages of heat with preference given to heat pump stages.

### Heat Pumps

The controller will use terminals Y1, Y2 and O/B to control heat pump operation for each configured unit. If units are configured for single stage heat pump operation, Y1 will be energized and O/B will be energized (or de-energized depending upon configuration) for heat pump operation. If units are configured for two stage heat pump operation, Y1 will be energized and O/B will be energized (or de-energize depending upon configuration) first and Y1, Y2 and O/B will be energized (or de-energized depending upon configuration) for an additional stage of heat pump operation. O/B configuration will determine if O/B will energize or de-energize for heat pump operation and will be included in the Guided Setup options.

**TABLE 1**  
**MC5000 Series Set Points/Defaults/User Settings Record**

<b>Set Point (SP) or Item Name</b>	<b>Current Range</b>	<b>Default</b>	<b>User Settings</b>
Cooling Set Point	4° above Heating SP to 90°F	77	
Heating Set Point	32°F to 4° below Cooling SP	60	
Comfort Mode Cooling Set Point	4° above Comfort Heating SP to 90°F	72	
Comfort Mode Heating Set Point	32°F to 4° below Comfort Cooling SP	68	
Dehumidification Level	10-100% RH +10% above Humidification Level	80%	
Humidification Level	0-90% RH +10% under Dehumidification Level	45%	
Cooling Interstage Differential	.5 – 5	1	
Cooling Off Differential	.5 – 5	2	
Heating Interstage Differential	.5 – 5	1	
Heating Off Differential	.5 – 5	2	
Dehumidification Interstage Differential	0 – 5	5	
Dehumidification Off Differential	1 – 15	10	
Humidification Interstage Differential	0 – 5	5	
Humidification Off Differential	1 – 15	10	
High Humidity Alarm Set Point	65 – 95	85	
Low Humidity Alarm	0 – 80	25	
Low Temperature Alarm Level	65 – 28	40	
High Temperature Alarm Level 1	70 – 120	80	
High Temperature Alarm Level 2	70 – 120	90	
Heat Pump Lockout Range	None, 5 – 50	None	
<i>Equipment Setup Items</i>			
Number of HVAC Units	1 – 6	1	
Number of Compressor Stages	1 or 2	1	
Heat Pump Enabled	Yes or No	No	
O/B Configuration	Energize in Heating or Energize in Cooling	Heating	
Number of Electric Heat Stages	1 or 2	1	
Max Units in Generator Mode	1 – 6	6	
Number of Dehumidification Units	0 – 6	0	
Dehumidification Type	Mechanical, Synchronized or None	None	
Dehumidification Count	0 – 6	0	
Humidification	Yes or No	No	
Economizer Present	Yes or No	No/Hidden	
Dust Sensor Type	Dry Contact, Analog or None	Dry Contact/ Hidden	

**TABLE 1 (cont.)  
MC5000 Series Set Points/Defaults/User Settings Record**

<b>Set Point (SP) or Item Name</b>	<b>Current Range</b>	<b>Default</b>	<b>User Settings</b>
Auxiliary Out Configuration	Emergency Off, Gen Run, High Humidity Alarm, Dust Alarm or Dehum Active	Emergency Off	
<i>System Setup Items</i>			
Languages	English, French or Spanish	English	
Password Protection	Yes or No	No	
Staging Logic	Alternating or Non-Alternating	Alternating	
Lead/Lag Changeover Time	0 – 30 Days 0 = Disable	7 Days	
Continuous Blower Logic	Lead, All, None, Pre-Purge or Custom	None	
Pre-Purge	1 – 5 Minutes	1 Minute	
Degrees	Fahrenheit or Celsius	Fahrenheit	
Temperature Sensor Logic	Average, Highest or Lowest	Average	
REM 1 Temperature Sensor	Indoor Temperature or Not Connected	Not Connected	
REM 2 Temperature Sensor	Indoor Temperature, Outdoor Temperature or Not Connected	Not Connected	
Minimum Run Time	0 – 5 Minutes	3 Minutes	
Maximum Number of Units While in Generator Mode	1 – 6 Units	1	
Touch Screen Display Brightness	10 – 100%	80%	
<i>Time Settings</i>			
Hour	1 – 12		
Minute	0 – 59		
AM or PM	AM or PM		
<i>Date Settings</i>			
Month	1 – 12		
Day	1 – 31		
Year	2000 – 2999		
<i>Sensor Calibration Values</i>			
Local Temperature	-15 – 15°F		0
Local Humidity	-15 – 15% RH		0
Remote 1	-15 – 15°F		0
Remote 2	-15 – 15°F		0

## Humidity Control Option

### Dehumidification Sequence

#### *Mechanical Sequence (see Figure 6)*

The controller will use terminal D for control of the dehumidification operation on each configured unit. The controller will energize D when dehumidification is required. Terminal D will be de-energized once dehumidification is no longer required or available. If any configured unit is actively heating or cooling then dehumidification will be unavailable until heating/cooling demand is satisfied. If configured to do so, the Aux. Out terminal will change state.

**FIGURE 6**  
**MC5600 Mechanical Dehumidification**

Three units were selected in setup for HGR Dehum



MECHANICAL DEHUM utilizes 1 thru 6 units with this feature and the number of units selected in this setup.

All dehum units **MUST BE** placed at the lowest number (1). Lead unit for dehum is always unit number 1 regardless of rotation lead location for other functions.

**NOTE:** Synchronized Dehum in pairs only, Mechanical Dehum 1 thru 6.



### Synchronized Sequence (see Figure 7)

The controller will use 50% of the configured units for heating and 50% of the configured units for cooling for Synchronized Dehumidification. This option will not be available unless there are at least two configured units with electric heat capability. Dehumidification will be limited to 2, 4, or 6 units. These options will be selectable in the Equipment Setup pages once Synchronized has been selected. The controller will energize W1 + W2 on the units allocated for heating and Y1 + Y2 on the units allocated for cooling if dehumidification demand is present. Unit allocation will begin with heating in the lead unit and cooling in the first lag unit and continue alternating until all available units are active. Stages will increase according to the set point plus the interstage differential. Synchronized Dehumidification will only activate an even number of units (2, 4, or 6). If configured to do so, the Aux. Out terminal will change state.

If any configured unit is actively heating or cooling, dehumidification will be unavailable until heating/cooling demand is satisfied.

### Humidification Operation

The controller will use the H terminal for control of the humidification if configured. If configured for humidification, H will energize when humidification is required and de-energize once satisfied.

### Staging

Staging in the MC5000 series controller can be configured by the user in an alternating or non-alternating format. In addition, heating or cooling staging will consider space temperature, heating/cooling set point and interstage differentials. Humidification and dehumidification staging will consider space humidity, humidification/dehumidification set point and interstage differentials.

### Staging Sequence

- Heating, cooling, dehumidification and humidification will all use the same staging structure in either a direct acting or reverse acting manner.
- All staging will utilize a set point, interstage differential, off differential, staging delay and minimum on time.

Set Point: The starting point for each operation.

Interstage Differential: The temperature distance between each stage.

Off Differential: This is how much a particular stage needs to decrease from the on point before the stage will turn off.

**FIGURE 7**  
**Synchronized Dehumidification**

Four units were selected in setup for Synchronized Dehum

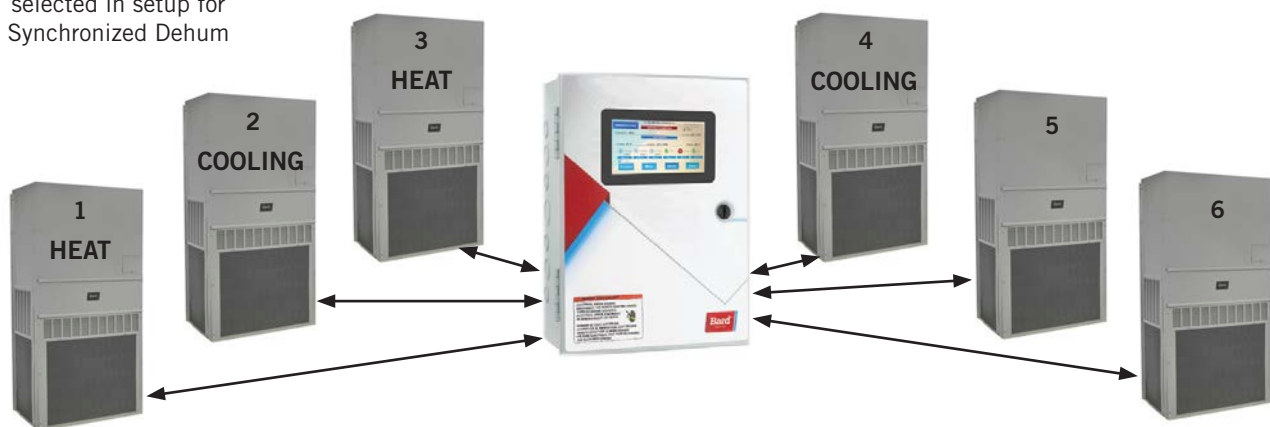

SYNCHRONIZED DEHUM utilizes a pair of units. Unit 1 (of pair) will run in heat and Unit 2 (of pair) will run in cooling. All dehum units MUST BE placed at the lowest number (1). Lead unit for dehum is always unit number 1 regardless of rotation lead location.

**NOTE:** Synchronized Dehum in pairs only, Mechanical Dehum 1 thru 6.

### Heating Staging

Heating staging begins when the space temperature is less than the heating set point. Staging will increase when the space temperature is less than the heating set point **and** heating interstage differential combined. Staging increases will continue each time space temperature decreases greater than the heating interstage differential setting. Heating stage decreases will happen inversely to the staging increases.

Figure 8 illustrates a simple two stage sequence of operation for heating with set point of 59.5°F, 1°F interstage differential and 2°F off differential.

### Cooling Staging

Cooling staging begins when the space temperature is greater than the cooling set point. Staging will increase when the space temperature is greater than the cooling set point **and** cooling interstage differential combined. Staging increases will continue each time space temperature increases greater than the cooling interstage differential setting. Cooling stage decreases will happen inversely to the staging increases.

**NOTE:** If a Unit Power Loss or Lock Out Alarm is present, the unit in alarm will not be considered in staging sequence—it will be skipped.

### Adjustable Interstage Differential (.5° TO 5°F)

User-selectable interstage differential based on specific shelter applications. The first stage will cycle on when crossing the set point. Subsequent stages will be energized when crossing the set point plus the differential for each stage until all required stages are used. For example: 77°F set point/.5° differential. Stage one is energized at 77.1°F, stage two at 77.6°F and so on (default is 1°F).

### Adjustable Off Differential (.5° TO 5°F)

User selectable off differential stages cycle off in reverse order as the temperature crosses the on point minus the off differential (default is 2°F).

### Cooling with Economizer (Single Stage Compressor and Economizer Available Alternating Sequence)

Figure 9 shows the temperature band from the set point of 77°F to the last unit turning on in 11°F.

**FIGURE 8**  
Heating Staging

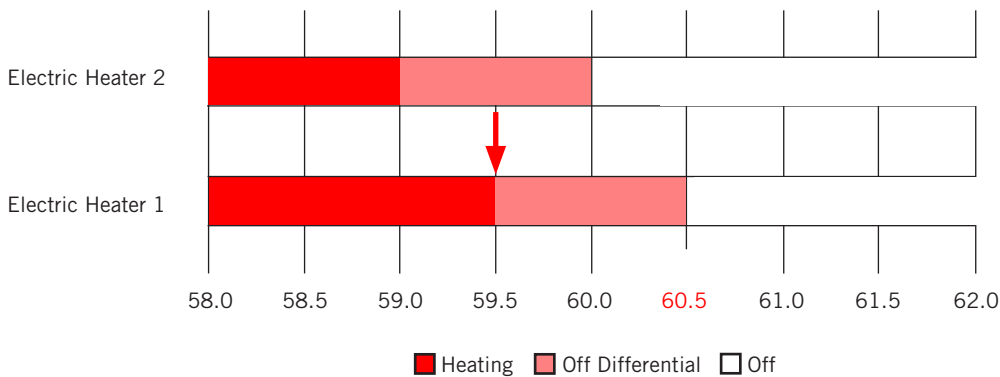

**FIGURE 9**  
Cooling with Six Single Stage Units (w/Economizers)

**Defaults**

Setpoint: 77°F  
Interstage Differential: 1°F  
Off Differential: 2°F

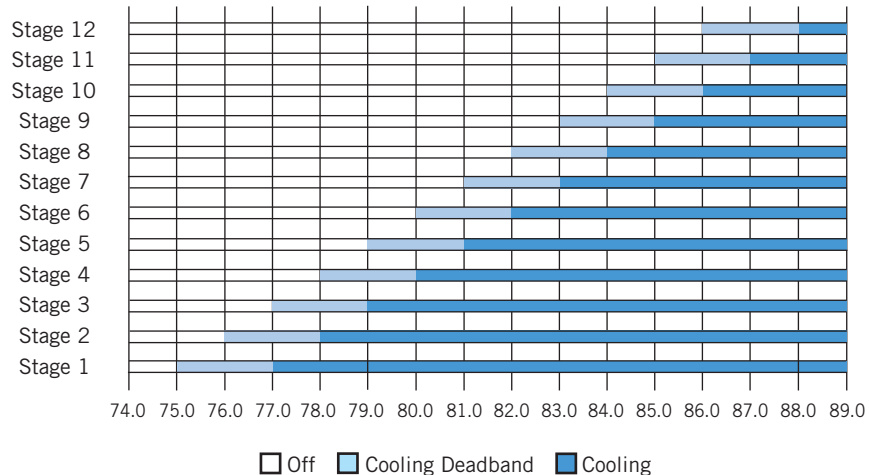

**The Advantages of Twinning: Pairs**

Using the same number of units as shown in Figure 9 (six units w/economizers) and selecting the **Pairs** option in **Twinning**, the number of stages can be reduced to six by engaging two units per stage (see Figure 10). This reduces the temperature range in the building by 50% as well (5°F).

**The Advantages of Twinning: Triples**

Using the same number of units and selecting the **Triples** option in **Twinning**, the number of stages can be reduced to four and the space temperature narrowed even more, from singles (77°F to 88°F, 11°F total) to pairs (77°F to 82°F to, 5°F total) to triples (77°F to 83°F, 3°F total) as shown in Figure 11. Be sure to consider the total number of stages and choose the best option for the application.

**FIGURE 10**  
Cooling with Six Single Stage Units (w/Economizers) Using Twinning/Pairs Option

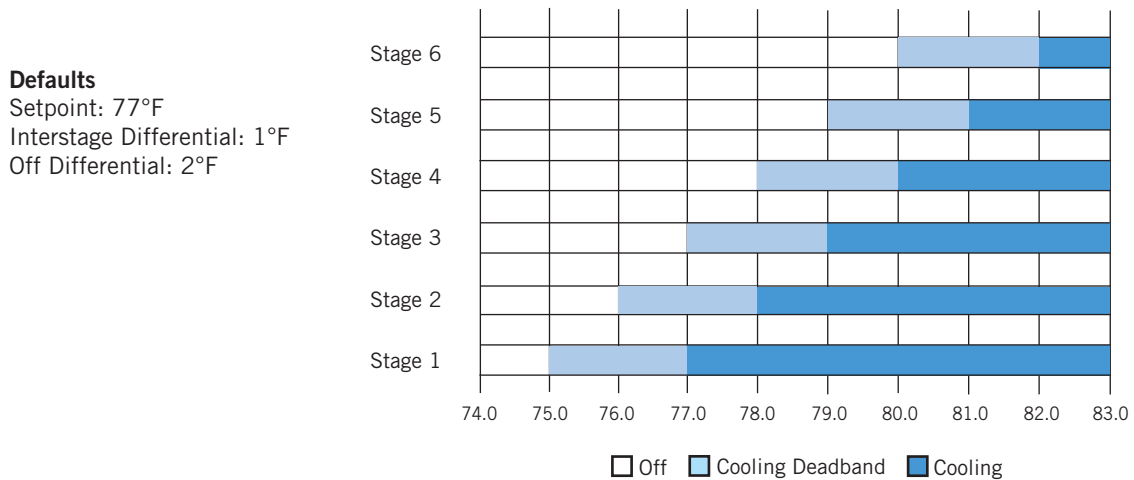

By pairing units, the temperature spread to bring on all resources goes from 11°F down to 5°F.

**FIGURE 11**  
Cooling with Six Single Stage Units (w/Economizers) Using Twinning/Triples Option

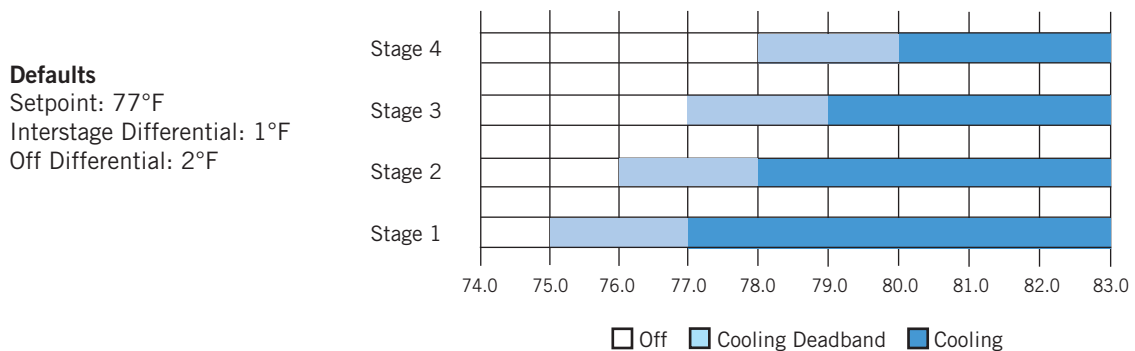

### Humidification/Dehumidification Demand Staging

Humidification staging begins when the space humidity is less than the humidification set point. Staging will increase when the space humidity is less than the humidification set point and humidification interstage differential combined. Staging increases will continue each time space humidity decreases greater than the humidification interstage differential setting. Humidification stage decreases will happen inversely to the staging increases.

Dehumidification staging begins when the space humidity is greater than the dehumidification set point. Staging will increase when the space humidity is greater than the dehumidification set point and dehumidification interstage differential combined. Staging increases will continue each time space humidity increases greater than the dehumidification interstage differential setting. Dehumidification stage decreases will happen inversely to the staging increases.

### Alternating and Non-Alternating Setup

#### Alternating/Non-Alternating Logic

The MC5000 series controller offers two staging sequence options: Alternating (default) or Non-Alternating.

#### Alternating

Alternating Logic will be the default for this controller. In the Alternating Logic stage, increases will start with the lead unit for the first stage and then alternate to the next available unit for sequential stages. Decreases in staging will happen in the exact opposite sequence. See example of a 3-unit system with 2 stage compressor and economizer in Table 2.

**TABLE 2**  
**Alternating Logic: 3-Unit System with 2 Stage Compressor and Economizer**

Stage	Unit 1	Unit 2	Unit 3
1	Y1	OFF	OFF
2	Y1	Y1	OFF
3	Y1	Y1	Y1
4	Y1, Y2	Y1	Y1
5	Y1, Y2	Y1, Y2	Y1
6	Y1, Y2	Y1, Y2	Y1, Y2

#### Non-Alternating

Non-Alternating Logic stage increases will start with the lead unit and exhaust all available stages prior to staging the next unit. Decreases in staging will happen in the exact opposite sequence. See example of a 3-unit system with 2 stage compressor and economizer in Table 3.

**TABLE 3**  
**Non-Alternating Logic: 3-Unit System with 2 Stage Compressor and Economizer**

Stage	Unit 1	Unit 2	Unit 3
1	Y1	OFF	OFF
2	Y1, Y2	OFF	OFF
3	Y1, Y2	Y1	OFF
4	Y1, Y2	Y1, Y2	OFF
5	Y1, Y2	Y1, Y2	Y1
6	Y1, Y2	Y1, Y2	Y1, Y2

**FIGURE 12**  
**Alternating Sequence Cooling**

Stage	Unit 1	Unit 2	Unit 3
<span style="border: 1px solid black; padding: 0 2px;">G</span> 1	(Y1)	OFF	OFF
<span style="border: 1px solid black; padding: 0 2px;">G</span> 2	Y1	(Y1)	OFF
<span style="border: 1px solid black; padding: 0 2px;">G</span> 3	Y1	Y1	(Y1)
4	Y1, (Y2*)	Y1	Y1
5		Y1, (Y2*)	Y1
6			Y1, (Y2*)

Alternating the staging will always bring on ALL economizers (when used and conditions allow) before any compressors are started. If no economizers are installed on single stage units, the mechanical cooling will start in sequence.

**NOTE:** When an economizer is used with two stage units, there is one more stage per unit (when available). In this example, there are nine total stages. The last three stages are activated by the JADE control.

\* For two stage units with economizers in alternating sequence, 2<sup>nd</sup> stage mechanical cooling will be activated by the JADE™ control base on time (default TD 15 minutes). In this example, full load mechanical will start 15 minutes after Y2 is energized (delay time is adjustable in JADE setup).

**FIGURE 13**  
**Non-Alternating Sequence Cooling**

Stage	Unit 1	Unit 2	Unit 3
<span style="border: 1px solid black; padding: 0 2px;">G</span> 1	(Y1)	OFF	OFF
2	Y1, (Y2*)	OFF	OFF
<span style="border: 1px solid black; padding: 0 2px;">G</span> 3	Y1, Y2*	(Y1)	OFF
4	Y1, Y2*	Y1, (Y2*)	OFF
<span style="border: 1px solid black; padding: 0 2px;">G</span> 5	Y1, Y2*	Y1, Y2*	(Y1)
6	Y1, Y2*	Y1, Y2*	Y1, (Y2*)

Non-alternating setup will always bring on ALL stages of the lead unit before calling on unit 2 and so on. Y1 would be economizer (if available); Y2 would be mechanical cooling.

**NOTE:** When an economizer is used with two stage units, there is one more stage per unit (when available). In this example, there are nine total stages. The last three stages are activated by the JADE control.

\* For two stage units with economizers in non-alternating sequence, 2<sup>nd</sup> stage mechanical cooling will be activated by the JADE™ control base on time (default TD 15 minutes). In this example, full load mechanical will start 15 minutes after Y2 is energized (delay time is adjustable in JADE setup).

### Twinning: Simultaneous Unit Operation

See Figure 14.

- Units operate simultaneously: Off ALL Pairs Triples
- Units stage on and off in their assigned groups (two or three)
- Available for four or six units only (MC5600 required)
- User-selectable setup where two or three units start/count as one stage

**NOTE:** Even though two or three units count as a stage and are cycled together, there will be a 5-second delay between units.

- Paired – Only available with four or six units. Units will operate in pairs.
- Four total units: Units 1 and 2 will stage simultaneously and units 3 and 4 will stage simultaneously. Lead/lag rotation will be in pairs.
- Six total units: Units 1 and 2 will stage simultaneously, units 3 and 4 will stage simultaneously and units 5 and 6 will stage simultaneously. Lead/lag rotation will be in pairs.
- Lead would be units 1 & 2, 3 & 4 or 5 & 6. Lead will still rotate one unit at a time. When unit 1 or 2 is lead, 1 & 2 will be lead, and so on.

**FIGURE 14**  
**Twinning: Simultaneous Unit Operation**



Twinning can reduce the number of stages required to bring on resources keeping the interstage differential range tighter. For example: Using 77°F as a set point and controlling six units with economizers will have 12 stages. If there is a .5°F interstage differential, there will be 6°F between set point and last stage on, making a 77°F run under full load at 83°F. By twinning, the control reduces the number of stages to six and the resulting temperature spread to 3°F or 80°F.

**NOTE:** All units connected in "home run" configuration only.

### Triples: Simultaneous Unit Operation

See Figure 15.

Using groups of three for the purpose of staging can give the end user even tighter temperature control.

- Triples – Only available with six units. Units will operate in sets of three.

- Units will stage simultaneously in sets of three. Units 1, 2 and 3 will be one set and units 4, 5 and 6 will be the second set.
- Lead would be units 1, 2, 3 & 4, 5, 6. Lead will still rotate one unit at a time. When a unit in the group is lead, that group is lead.

**FIGURE 15**  
**Triples: Simultaneous Unit Operation**



Using groups of three can reduce the number of stages and maintain a tighter temperature band. With the twinning option, the user can select All, Pairs or Triples.

**NOTE:** All units connected in "home run" configuration only.

## Alarm Functionality

All alarms shall have a 5-second delay (alarm criteria must be met for 5 seconds) prior to triggering alarm to prevent nuisance alarming. When any alarm is triggered, the Alarm button on the Home Screen will blink red, alarm will be listed in Active Alarm screen until cleared and alarm will be logged in the alarm log unless otherwise configured via the webpages. The Alarm Configuration page will allow for users to select the options Disable, Enable or Output Logic Only. If Enable is selected, the above description will apply. If Disable is selected, none of the sequences tied to that alarm will apply. If Output Logic Only is selected (Dust and Ventilation only), the output logic will still function but the alarm will not show under active alarms or be logged in the alarm log.

### Low Temperature Alarm

If the space temperature reading/calculation is below the Low Temperature alarm set point, a Low Temperature alarm will be triggered. If controller is equipped with optional alarm board, the Low Temp relay will change state. Alarm will clear once space temperature is above the Low Temperature alarm set point.

### High Temperature 1 Alarm

If the space temperature is above the High Temperature 1 alarm set point, a High Temperature 1 alarm will be triggered. If controller is equipped with optional alarm board, the High Temp 1 relay will change state. Alarm will clear once space temperature is below the High Temperature 1 alarm set point.

### High Temperature 2 Alarm

If the space temperature is above the High Temperature 2 alarm set point, a High Temperature 2 alarm will be triggered. If controller is equipped with optional alarm board, the High Temp 2 relay will change state. Alarm will clear once space temperature is below the High Temperature 2 alarm set point. The "A" terminal will be energized while this alarm is active.

### High Humidity Alarm

If space humidity is above the High Humidity alarm set point, a High Humidity alarm will be triggered. The High Humidity alarm will be cleared if space humidity is below the High Humidity set point. If configured to do so, the Aux. Out terminal will change state for economizer disable.

### Low Humidity Alarm

If space humidity is below the Low Humidity alarm set point, a Low Humidity alarm will be triggered. The Low Humidity alarm will be cleared if space humidity is above the Low Humidity alarm set point.

## Emergency Off Alarm

If Emergency Off input becomes active, an Emergency Off alarm will be triggered. All outputs to units (W1, W2, EC, Y1, Y2, G O/B, A, D and H) will be de-energized. If configured, the unit Aux. Out relay will change state. This is the default and it may be configured differently if desired. If controller is equipped with optional alarm board, the Emergency Off relay will change state. The alarm will clear once the Emergency Off input becomes inactive. Once cleared, unit staging will begin as it would at the beginning of any call if a call is present. The default configuration for the Emergency Off terminals should be NC and alarm on loss of continuity/opening of the contacts.

### Generator Run Alarm

If Generator Run input becomes active, a Generator Run alarm will be triggered. The Generator Run alarm will clear once the Generator Run input becomes inactive. If controller is equipped with optional alarm board, the Generator relay will change state. While the Generator Run alarm is active only the number of units set in Max Units in Generator Mode will be allowed to operate. The count will start with the lead unit and increment with each additional unit activated in heating or cooling. The default setting on this feature is all, which will not limit the number of units allowed to stage on in heating or cooling during an active Generator Run alarm. All humidification and dehumidification will be disabled while Generator Run Alarm is active due to separate staging sequence from heating and cooling. If configured to do so, the Aux. Out terminal will change state.

### Ventilation Alarm

If the Vent input becomes active, a Ventilation alarm will be triggered. During an active Ventilation alarm, the controller will energize the G and A terminal for every configured unit and if equipped with an optional alarm board, the Vent relay will change state. The Ventilation alarm will clear once the Vent input becomes inactive. This alarm will have the ability to be configured for Output Logic Only via the webpages. Output Logic only will block the logging of the alarm into the alarm log and prevent alarm from being listed in the Active Alarms list.

### HVAC Power Loss Alarm

If any configured unit fails to provide 24 VAC to corresponding R terminal, an HVAC Power Loss alarm will be triggered. This alarm will include a unit identifier (1-6) tag in the alarm description. While active, if the controller is equipped with an optional alarm board, the Power Loss relay associated to the corresponding unit will change state. The HVAC Power Loss alarm will clear once 24 VAC is present at the R terminal corresponding to the unit triggering the alarm.



### HVAC Compressor Lockout Alarm

If the LOR input for any configured unit becomes active, an HVAC Compressor Lockout alarm will be triggered. This alarm will include a unit identifier (1-6) tag in the alarm description. If controller is equipped with optional alarm board, the HVAC Lockout relay associated with the unit will change stage. The HVAC Compressor Lockout alarm will clear once the LOR for the corresponding unit becomes inactive.

### HVAC Maintenance Alarm

If the filter input for any configured unit becomes active, then an HVAC Maintenance alarm will be triggered. This alarm will include a unit identifier (1-6) tag in the alarm description. If controller is equipped with optional alarm board, the HVAC Maintenance relay associated with the unit will change stage. The HVAC Maintenance Alarm will clear when Filter input for corresponding unit becomes inactive.

### HVAC Dust Alarm

If the dust input for any configured unit becomes active, an HVAC Dust alarm will be triggered. This alarm will include a unit identifier (1-6) tag in the alarm description. The HVAC Dust alarm will be cleared once the dust input becomes inactive. If configured to do so, the Aux. Out terminal will change state for economizer disable. This alarm will have the ability to

be configured for Output Logic Only via the webpages. Output Logic only will block the logging of the alarm into the alarm log and prevent alarm from being listed in the Active Alarms list.

### Control Fail Output

A Control Fail relay is incorporated into controllers with the optional alarm board. This relay will change state if communication is lost between the alarm board and I/O board or I/O board and display.

### Temperature Sensor Failure Alarms

In the event that the primary temperature/humidity sensor fails (open or shorted), an alarm will be generated. If no optional REM (remote) temperature sensors are installed, all temperature and humidity control will be disabled and all units will stop operating. If equipped with optional REM sensors that are configured for indoor temperature, temperature control will continue using the REM sensor for consideration in control. Additionally, if a REM temperature sensor is configured and is disconnected or shorted, an alarm will be generated and the sensor in question will not be considered for temperature control logic. This shall provide redundancy for temperature control in the event of a single temperature sensor failure for critical applications.

**TABLE 4**  
**MC5000BC Series Alarm Functions**

Alarm Condition	Terminals Available	Default	Action
1. Low Temperature Alarm	Output avail (1 collective)	40°F	Alarm only
2. High Temperature Alarm #1	Output avail (1 collective)	80°F	Alarm only
3. High Temperature Alarm #2	Output avail (1 collective)	90°F	Alarm and "A" terminal activates on all unit terminal strips for ventilation
4. Dirty Filter Alarm	Output avail (1 collective)		Alarm only (maintenance alarm)
5. Emergency Off	Output avail (1 collective)		All functions stop
6. Generator Run Alarm	Output avail (1 collective)	ALL	Limits units available to run
7. Ventilation	Output avail (1 collective)		Alarm and "A" terminal activates on all unit terminal strips for ventilation
8. Unit Lock Out Alarm (1 per unit)	Output avail (1 per unit)		Switch to "next on" (HP or LP only)
9. High Humidity Alarm	No external output	85%RH	Close economizer (if configured)
10. Low Humidity Alarm	No external output	25%RH	Alarm only
11. Unit Power Loss Alarm (1 per unit)	Output avail (1 per unit)		Alarm and rotation moves to "next on"
12. Theft Alarm	Output avail (1 collective)		Alarm only (all units report to one output)
13. Control Fail Alarm	Output avail (1)		Alarm Only

## Test Mode

Two test modes are available on this controller, Self Test and Manual Test. The test modes can be accessed via the Menu button on the Home Screen.

### Self Test

In Self Test, all functionality configured for each unit can be activated for 300 seconds beginning with the lead unit. Each stage is advanced by a user-activated button on the Self Test screen. Stages available include Blower, Cooling Stages 1 & 2, Electric Heat Stages 1 & 2, Dehumidification, Humidification and Heat Pump Stages 1 & 2. Stages available during test will be dependent upon equipment configuration and will only include the stages that are configured.

The user advances the unit via a user-activated button on the Self Test screen. The user can also increase the time duration of any stage to 1200 seconds via a button on the Self Test screen. The user can also terminate the test via a button on the Self Test screen at any time; if this is the case, all outputs will be de-energized and the controller will return to the Home screen and normal operation will resume.

During the Self Test, the terminals designated in the sequences in this document will become active independent of space temperature or humidity considerations while the Self Test is active. Once the timer expires for a stage in the Self Test, the next stage will begin unless the duration has been increased to 1200 seconds via the "Hold" button; if this is the case, all outputs will be de-energized and the controller will return to the Home screen and normal operation will resume.

Self Test will always start with unit 1 and priority to stages will be as listed below:

1. Blower
2. Cooling Stage 1
3. Cooling Stage 2
4. Heat Pump Stage 1
5. Heat Pump Stage 2
6. Electric Heat Stage 1
7. Electric Heat Stage 2
8. Dehumidification
9. Humidification

### Manual Test

In Manual Test, the user will be provided buttons on the Manual Test screen corresponding to all outputs designated to a configured unit and each configured unit will have a tab assigned. As the output button is activated, the corresponding terminal will be energized for 500 seconds. Terminals include W1, W2, Y1, Y2, O/B, A, D, H, Aux Out and G.

## Network/Remote Connectivity

See Table 5 for the default network settings.

**TABLE 5**  
**Default Network Settings**

Default Network Settings	
IPv4	
IP	192.168.1.67
Subnet	255.255.255.0
IPv6	
IP	2001:00DB:AAAA:2222::14

### Remote Connectivity

# IMPORTANT

***When connecting this product from a remote location, ensure that the network connection is secure and reliable.***

The MC5000 series controllers have remote connectivity available utilizing an Ethernet connection located on the back of the touch screen display (see Figure 16). Network configuration can be done from the touch screen display or via the webpages and can be configured for use on IPV4 and IPV6 networks. Modbus TCIP and built-in webpages allow for easy access to unit and controller information as well as configuration settings.

### Setup

#### ***Touch Screen Display IP Configuration***

From the home screen, press the Setup menu button (see Figure 17). In the Setup menu, press the IP Configuration tab to navigate to the IP Configuration page. On this page, the DHCP (enable/disable) should be configured first. If DHCP is disabled, the IPv4 address, IPv4 Subnet mask, IPv4 Default gateway, IPv4 Primary DNS and IPv4 Secondary DNS can be set by touching the dialog box and entering information on the popup keypad. To configure the IPv6 settings, the IPv6 tab on the right side of the screen will need to be pressed to navigate to the IPv6 settings. Once settings are configured, the Apply Settings tab must be pressed prior to navigating from screen for the settings to be saved and applied. Once settings are saved, the Return tab can be used to return to the Setup menu.

**FIGURE 16**  
Back of Touch Screen Display

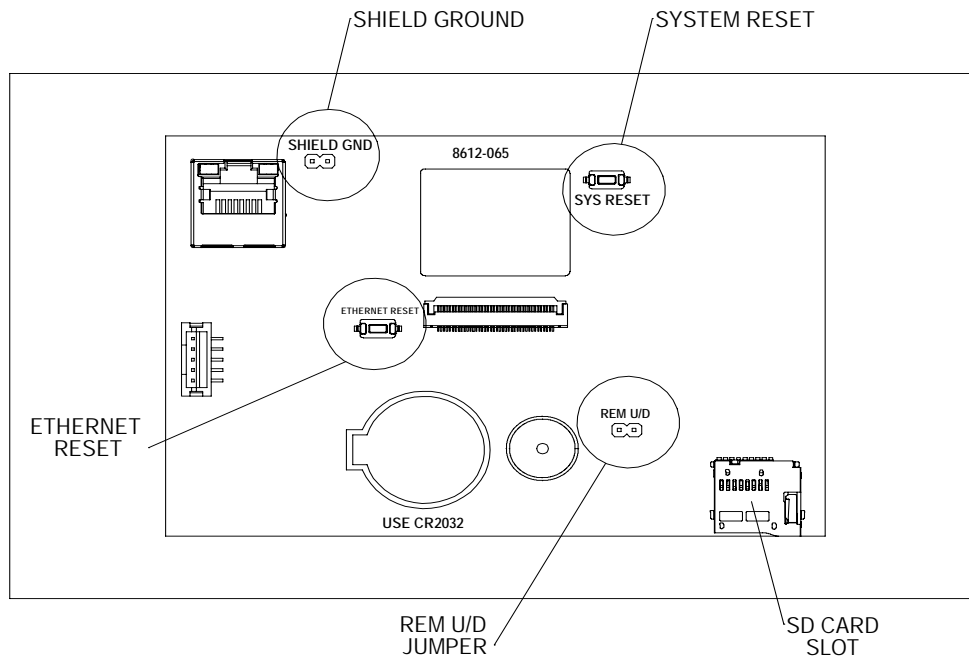

MIS-4194A

1. Ethernet Reset – Pressing the Ethernet Reset button will revert all IP settings back to the factory default settings. **NOTE:** Hold button for minimum of 10 seconds to activate reset.
2. REM U/D Jumper – With this jumper in place, updating of firmware is allowed. In the event this jumper is ever removed, place it onto one of the pins to prevent loss where it will be available if it becomes necessary to re-install it at a later date.
3. Shield/GND Jumper – Removing this jumper isolates the shielding around the Ethernet port from the network ground. It is recommended to leave the jumper in place unless issues with the network ground occur.
4. System Reset – Pressing the System Reset button will reset the display and retain the system settings. **CAUTION:** The System Reset button has an immediate response.
5. SD Card Slot – The SD card must be a micro SD card (FAT format only).

**FIGURE 17**  
Setup Button on MC5000 Series Home Screen

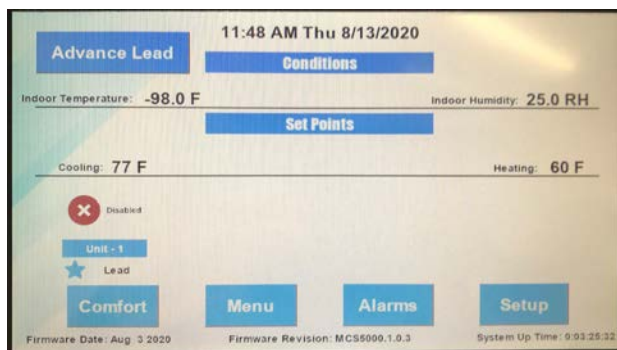

### Webpage IP Configuration

**NOTE:** If the initial network settings configuration are to be done via the webpage, an Ethernet patch cable will need to be connected to the controller and the default addressing will need to be used (see Table 5).

Once the webpage has loaded, press on the Network Configuration tab in the navigational pane (see Figure 18 on page 36). This will open up two additional tabs, IPv4 Configuration and IPv6 Configuration. Click the appropriate tab for configuration page.

**FIGURE 18**  
**Webpage Navigational Side Panel**

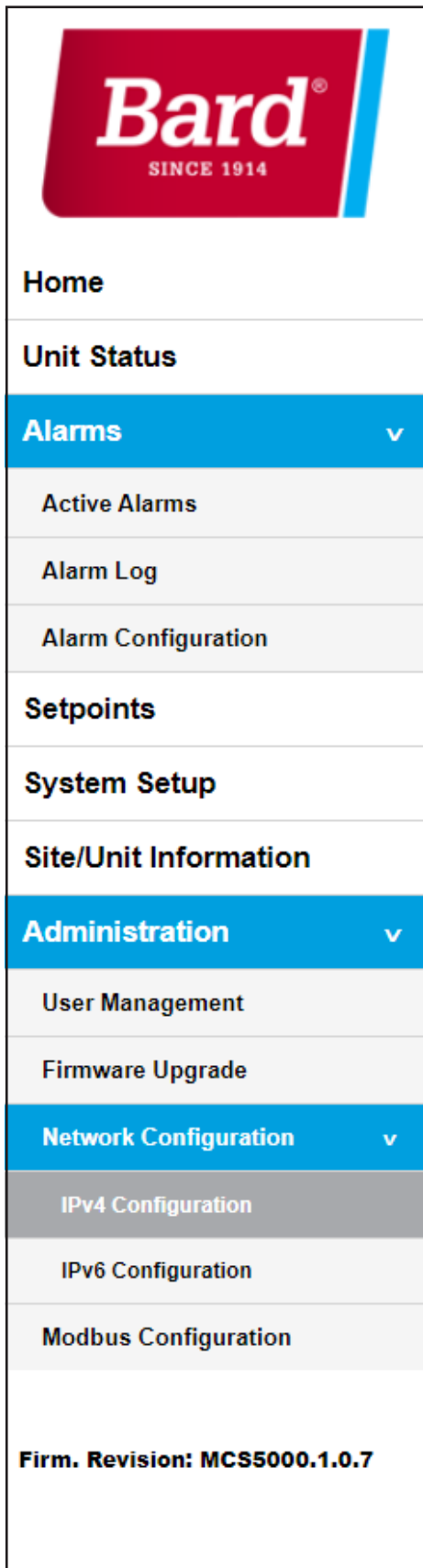

### Webpages

Webpage access requires a default username (admin) and password (bard); after logging in, the webpage prompts user to change the password to promote security. Usernames, passwords, and access levels can also be changed on the User Management page. Up to 10 users may be configured from this page. If a password is lost, the password settings can be adjusted by any user and password combination with administrator access or be defaulted by pressing and holding the Ethernet reset button for 10 seconds if no access is available. This action will require the user to reconfigure all the network settings including the IP address to restore remote access to the webpages. If webpage is inactive for more than 5 minutes or if a user logs out the controller will prompt a login on the next interaction.

### *Navigational Side Pane*

The navigational pane is provided on most of the webpage to allow users to quickly move through the webpages available on the controller (see Figure 18). Some of the buttons will act as dropdown menus and others will navigate directly to the page listed. Dropdown menus can be identified by the menu carrot to the right of the button text. The navigational pane also displays the current Firmware revision and date.

## Modbus

To enable Modbus, the user will need to access the webpages and enable the feature on the Modbus Configuration page located under the Administration tab on the navigational pane. This feature is disabled by default to prevent unauthorized access to the controller. Once enabled, changes can be made to

some of the controller settings without a password. Any access control to the Modbus will be dependent upon the network used to access the controller. Adjustable settings via Modbus are limited to set point type configuration and is intended to be primarily used to monitor the state and function of the controller during operation.

MC5300/MC5600 Modbus over TCP Protocol				
Function Codes: 03, 16, 23 - Input and Holding Registers				
Register Address	Register Description	Data Type	Register Type	Data Range
0	Cooling Set point	int16_t	Holding Register	65 - 90 °F
1	Heating Set point	int16_t	Holding Register	32 - Cooling Set point – (4 + Cooling Stage Off Differential)
2	Comfort Mode Cooling Set point	int16_t	Holding Register	65 - 90 °F
3	Comfort Mode Heating Set point	int16_t	Holding Register	32 - Comfort Mode Cooling Set point – (4 + Comfort Cooling Stage Off Differential)
4	Dehumidification Set point	int16_t	Holding Register	0 - 100 % RH
5	Humidification Set point	int16_t	Holding Register	0 - Dehumidification Set point – (10 + Dehumidification Stage Off Differential)
6	Cooling Interstage Differential Set point	int16_t (scaled by 10)	Holding Register	(5 - 50) 0.5 - 5.0 °F
7	Cooling Stage Off Differential Set point	int16_t (scaled by 10)	Holding Register	(5 - 50) 0.5 - 5.0 °F
8	Heating Interstage Differential Set point	int16_t (scaled by 10)	Holding Register	(5 - 50) 0.5 - 5.0 °F
9	Heating Stage Off Differential Set point	int16_t (scaled by 10)	Holding Register	(5 - 50) 0.5 - 5.0 °F
10	Dehumidification Interstage Differential Set point	int16_t (scaled by 10)	Holding Register	(0 - 50) 0.0 - 5.0 % RH
11	Dehumidification Stage Off Differential Set point	int16_t	Holding Register	1-15 % RH
12	Humidification Interstage Differential Set point	int16_t (scaled by 10)	Holding Register	(5 - 50) 0.5 - 5.0 % RH
13	Humidification Stage Off Differential Set point	int16_t	Holding Register	1-15 % RH

14	High Humidity Alarm Set point	int16_t	Holding Register	65 - 95 % RH
15	Low Humidity Alarm Set point	int16_t	Holding Register	0 - 80 % RH
16	Low Temperature Alarm Set point	int16_t	Holding Register	28 - 65 °F
17	High Temperature 1 Alarm Set point	int16_t	Holding Register	70 - 120 °F
18	High Temperature 2 Alarm Set point	int16_t	Holding Register	70 - 120 °F
19	Heat Pump Lockout Temperature Set point	int16_t	Holding Register	5 - 50 °F

Function Codes: 04 - Input Registers

Register Address	Register Description	Data Type	Register Type	Data Range
0	Logic Temp - Temperature used for staging decisions	int16_t	Input Register	-40 - 120 °F
1	Indoor Humidity - Humidity reported by local temp/humidity sensor	int16_t	Input Register	0 - 100 % RH
2	Outdoor Temp	int16_t	Input Register	-40 - 120 °F
3	Local Temp - Temperature reported by local temp/humidity sensor	int16_t	Input Register	-40 - 120 °F
4	Remote 1 Temperature	int16_t	Input Register	-40 - 120 °F
5	Remote 2 Temperature	int16_t	Input Register	-40 - 120 °F
6	Cooling Stage - Current stage of cooling	int16_t	Input Register	0 - 18 stages
7	Heating Stage - Current stage of heating	int16_t	Input Register	0 - 24 stages
8	Dehumidification Stage - Current stage of dehumidification	int16_t	Input Register	0 - 6 stages
9	Humidification Stage - Current stage of humidification	int16_t	Input Register	0 - 6 stages
10	Economizer Active - Active if economizer cooling is active	int16_t	Input Register	0 - no or 1 - yes
11	Outdoor Air Dusty - Active if outdoor air is dusty	int16_t	Input Register	0 - clean air or 1 - dusty air

Function Code: 02 - Discrete Inputs

Discrete Input Address	Discrete Input Description	Data Type	Data Range
0	Low Temperature Alarm	bit	0 (OFF) - 1 (ON)
1	High Temperature 1 Alarm	bit	0 (OFF) - 1 (ON)
2	High Temperature 2 Alarm	bit	0 (OFF) - 1 (ON)
3	Emergency Off Alarm	bit	0 (OFF) - 1 (ON)

4	Generator Run Alarm	bit	0 (OFF) - 1 (ON)
5	Theft Alarm	bit	0 (OFF) - 1 (ON)
6	Ventilate Alarm	bit	0 (OFF) - 1 (ON)
7	Local Temperature/Humidity Sensor Disconnect	bit	0 (OFF) - 1 (ON)
8	High Humidity Alarm	bit	0 (OFF) - 1 (ON)
9	Low Humidity Alarm	bit	0 (OFF) - 1 (ON)
100	System 1 - W1 - Electric Heat - Stage 1	bit	0 (OFF) - 1 (ON)
101	System 1 - W2 - Electric Heat - Stage 2	bit	0 (OFF) - 1 (ON)
102	System 1 - Y1 - Compressor - Stage 1	bit	0 (OFF) - 1 (ON)
103	System 1 - Y2 - Compressor - Stage 2	bit	0 (OFF) - 1 (ON)
105	System 1 - G - Blower	bit	0 (OFF) - 1 (ON)
106	System 1 - O/B - Reversing Valve	bit	0 (OFF) - 1 (ON)
107	System 1 - A Terminal	bit	0 (OFF) - 1 (ON)
108	System 1 - D - Mechanical Dehum	bit	0 (OFF) - 1 (ON)
109	System 1 - H - Humidifier	bit	0 (OFF) - 1 (ON)
110	System 1 - AUX - Auxiliary Terminal	bit	0 (OFF) - 1 (ON)
111	System 1 - Change Filter	bit	0 (OFF) - 1 (ON)
112	System 1 - Power Loss	bit	0 (OFF) - 1 (ON)
113	System 1 - Compressor Lockout	bit	0 (OFF) - 1 (ON)
114	System 1 - Dust	bit	0 (OFF) - 1 (ON)
200	System 2 - W1 - Electric Heat - Stage 1	bit	0 (OFF) - 1 (ON)
201	System 2 - W2 - Electric Heat - Stage 2	bit	0 (OFF) - 1 (ON)
202	System 2 - Y1 - Compressor - Stage 1	bit	0 (OFF) - 1 (ON)
203	System 2 - Y2 - Compressor - Stage 2	bit	0 (OFF) - 1 (ON)
205	System 2 - G - Blower	bit	0 (OFF) - 1 (ON)
206	System 2 - O/B - Reversing Valve	bit	0 (OFF) - 1 (ON)
207	System 2 - A Terminal	bit	0 (OFF) - 1 (ON)
208	System 2 - D - Mechanical Dehum	bit	0 (OFF) - 1 (ON)
209	System 2 - H - Humidifier	bit	0 (OFF) - 1 (ON)
210	System 2 - AUX - Auxiliary Terminal	bit	0 (OFF) - 1 (ON)
211	System 2 - Change Filter	bit	0 (OFF) - 1 (ON)
212	System 2 - Power Loss	bit	0 (OFF) - 1 (ON)
213	System 2 - Compressor Lockout	bit	0 (OFF) - 1 (ON)
214	System 2 - Dust	bit	0 (OFF) - 1 (ON)
300	System 3 - W1 - Electric Heat - Stage 1	bit	0 (OFF) - 1 (ON)
301	System 3 - W2 - Electric Heat - Stage 2	bit	0 (OFF) - 1 (ON)
302	System 3 - Y1 - Compressor - Stage 1	bit	0 (OFF) - 1 (ON)

303	System 3 - Y2 - Compressor - Stage 2	bit	0 (OFF) - 1 (ON)
305	System 3 - G - Blower	bit	0 (OFF) - 1 (ON)
306	System 3 - O/B - Reversing Valve	bit	0 (OFF) - 1 (ON)
307	System 3 - A Terminal	bit	0 (OFF) - 1 (ON)
308	System 3 - D - Mechanical Dehum	bit	0 (OFF) - 1 (ON)
309	System 3 - H - Humidifier	bit	0 (OFF) - 1 (ON)
310	System 3 - AUX - Auxiliary Terminal	bit	0 (OFF) - 1 (ON)
311	System 3 - Change Filter	bit	0 (OFF) - 1 (ON)
312	System 3 - Power Loss	bit	0 (OFF) - 1 (ON)
313	System 3 - Compressor Lockout	bit	0 (OFF) - 1 (ON)
314	System 3 - Dust	bit	0 (OFF) - 1 (ON)
400	System 4 - W1 - Electric Heat - Stage 1	bit	0 (OFF) - 1 (ON)
401	System 4 - W2 - Electric Heat - Stage 2	bit	0 (OFF) - 1 (ON)
402	System 4 - Y1 - Compressor - Stage 1	bit	0 (OFF) - 1 (ON)
403	System 4 - Y2 - Compressor - Stage 2	bit	0 (OFF) - 1 (ON)
405	System 4 - G - Blower	bit	0 (OFF) - 1 (ON)
406	System 4 - O/B - Reversing Valve	bit	0 (OFF) - 1 (ON)
407	System 4 - A Terminal	bit	0 (OFF) - 1 (ON)
408	System 4 - D - Mechanical Dehum	bit	0 (OFF) - 1 (ON)
409	System 4 - H - Humidifier	bit	0 (OFF) - 1 (ON)
410	System 4 - AUX - Auxiliary Terminal	bit	0 (OFF) - 1 (ON)
411	System 4 - Change Filter	bit	0 (OFF) - 1 (ON)
412	System 4 - Power Loss	bit	0 (OFF) - 1 (ON)
413	System 4 - Compressor Lockout	bit	0 (OFF) - 1 (ON)
414	System 4 - Dust	bit	0 (OFF) - 1 (ON)
500	System 5 - W1 - Electric Heat - Stage 1	bit	0 (OFF) - 1 (ON)
501	System 5 - W2 - Electric Heat - Stage 2	bit	0 (OFF) - 1 (ON)
502	System 5 - Y1 - Compressor - Stage 1	bit	0 (OFF) - 1 (ON)
503	System 5 - Y2 - Compressor - Stage 2	bit	0 (OFF) - 1 (ON)
505	System 5 - G - Blower	bit	0 (OFF) - 1 (ON)
506	System 5 - O/B - Reversing Valve	bit	0 (OFF) - 1 (ON)
507	System 5 - A Terminal	bit	0 (OFF) - 1 (ON)
508	System 5 - D - Mechanical Dehum	bit	0 (OFF) - 1 (ON)
509	System 5 - H - Humidifier	bit	0 (OFF) - 1 (ON)
510	System 5 - AUX - Auxiliary Terminal	bit	0 (OFF) - 1 (ON)
511	System 5 - Change Filter	bit	0 (OFF) - 1 (ON)
512	System 5 - Power Loss	bit	0 (OFF) - 1 (ON)



513	System 5 - Compressor Lockout	bit	0 (OFF) - 1 (ON)
514	System 5 - Dust	bit	0 (OFF) - 1 (ON)
600	System 6 - W1 - Electric Heat - Stage 1	bit	0 (OFF) - 1 (ON)
601	System 6 - W2 - Electric Heat - Stage 2	bit	0 (OFF) - 1 (ON)
602	System 6 - Y1 - Compressor - Stage 1	bit	0 (OFF) - 1 (ON)
603	System 6 - Y2 - Compressor - Stage 2	bit	0 (OFF) - 1 (ON)
605	System 6 - G - Blower	bit	0 (OFF) - 1 (ON)
606	System 6 - O/B - Reversing Valve	bit	0 (OFF) - 1 (ON)
607	System 6 - A Terminal	bit	0 (OFF) - 1 (ON)
608	System 6 - D - Mechanical Dehum	bit	0 (OFF) - 1 (ON)
609	System 6 - H - Humidifier	bit	0 (OFF) - 1 (ON)
610	System 6 - AUX - Auxiliary Terminal	bit	0 (OFF) - 1 (ON)
611	System 6 - Change Filter	bit	0 (OFF) - 1 (ON)
612	System 6 - Power Loss	bit	0 (OFF) - 1 (ON)
613	System 6 - Compressor Lockout	bit	0 (OFF) - 1 (ON)
614	System 6 - Dust	bit	0 (OFF) - 1 (ON)

# CONNECTION DIAGRAMS

**TABLE 6**  
**Connection Diagram Selection Table**

System Type	Model Series	Units with CRV-F or ERV-*, No Economizer without Balanced Climate	Units with CRV-F or ERV-*, No Economizer with Balanced Climate ①	Economizer/ No Balanced Climate ②
A/C with 1-Stage Compressor	W**A/W**L	Figure 19 (page 43)	Figure 20 (page 44)	Figure 21 (page 45)
Heat Pump	W**H	Figure 22 (page 46)	Figure 23 (page 47)	Figure 24 (page 48)
A/C with 2-Stage Compressor	W*SA*	Figure 25 (page 49)	Figure 26 ③ (page 50)	Figure 27 (page 51)
Heat Pump with 2-Stage Compressor	T**S ④	Figure 28 (page 52)	NA ⑤	Figure 28 (page 52)
Heat Pump with 2-Stage Compressor	C**H ④	Figure 29 (page 53)	NA ⑤	Figure 29 (page 53)
Heat Pump with 1-Stage Compressor	T**H ④	Figure 30 (page 54)	NA ⑤	Figure 30 (page 54)

① The Balanced Climate™ option is not available for any units using an economizer.

② The EIFM will work with the wiring diagrams utilizing the Economizer/No Balanced Climate option.

③ The CRV-F does not work with the W\*SA\* unit when the Balanced Climate option is being used.

④ The CRVMWH-\* and/or CHCRV-\* are not designed does to work with the MC5000 controller.

⑤ Balanced Climate is not an available option.

**NOTE:** The MC5000 controller is not designed to be used with the CRV-V, CHCRV-\*, CRVMWH-\* or ECON-NC\* vent options.

**FIGURE 19**  
**W\*\*A/W\*\*L Series Unit with CRV-F or ERV and No Ventilation or Balanced Climate**

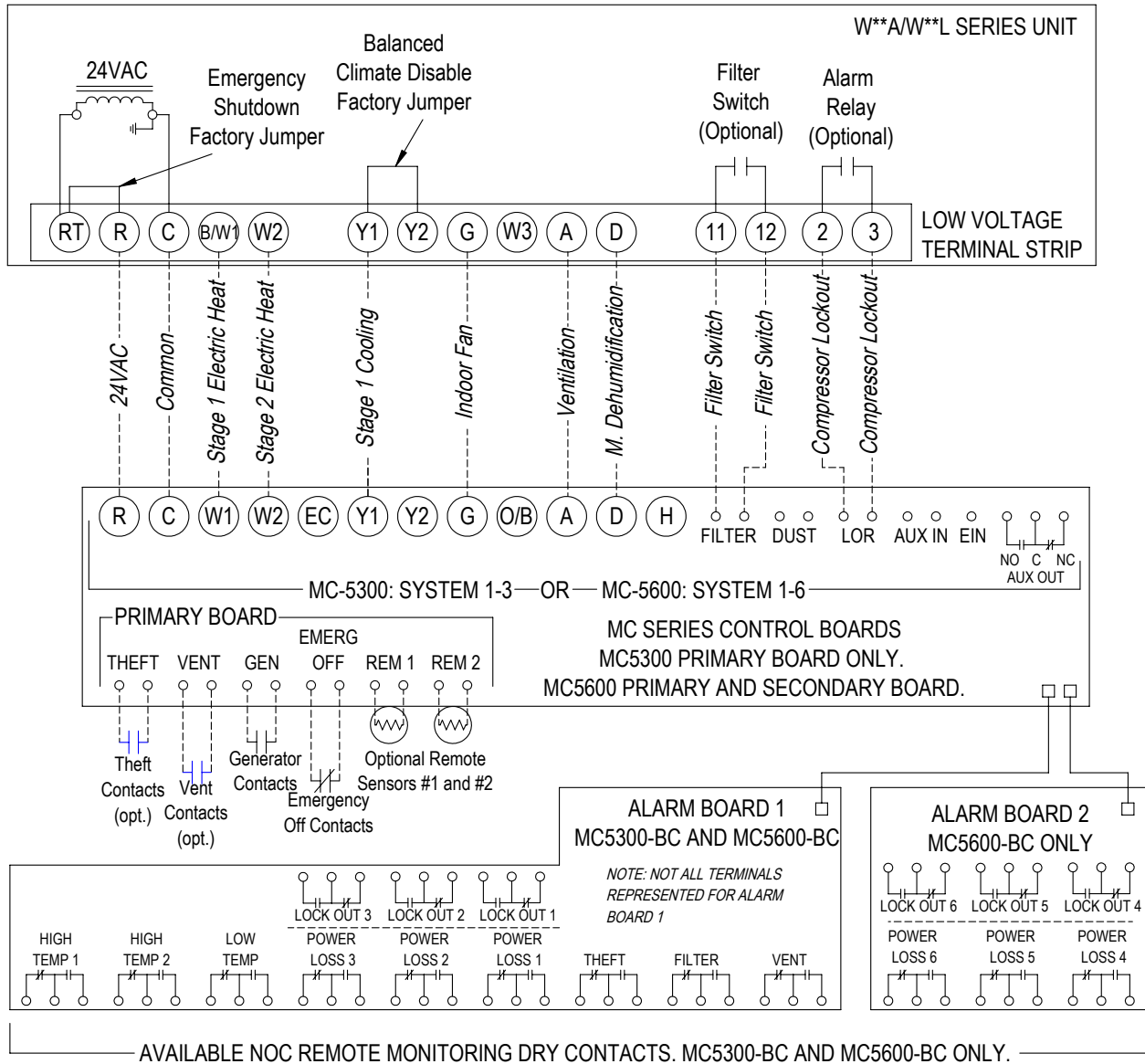

**Notes:**

- 1.) Stage 2 Electric Heat, Ventilation, Mechanical Dehumidification, and Filter Switch are optional components. Refer to model nomenclature to verify optional equipment installed in unit.
- 2.) Use VENT Contacts of Primary Board to activate ventilation using CO2 sensor or other peripheral device. Jumper VENT contacts for constant ventilation. Option must be used to activate "A" terminal with CRV-F and ERV ventilation options.
- 3.) Optional remote sensors #1 and #2 are temperature resistance 10k type 2. Remote sensor #2 can be used as an outdoor or indoor sensor.
- 4.) Emergency Off Contacts used in MC series controller to shut down all units. Emergency shutdown factory jumper may be removed to field install a normally closed relay at each individual unit.
- 5.) Balanced Climate factory jumper between Y1 and Y2 is not removed. See unit installation manual for additional details regarding Balanced Climate mode of operation.
- 6.) All MC controllers will have a primary control board with connections for units 1 to 3. MC5600 controllers only will have an additional secondary control board with connections for units 4 to 6.
- 7.) MC5300-BC and MC5600-BC controllers have additional alarm board(s) with dry contacts for wired alarms.

MIS-4195 A

**FIGURE 20**  
**W\*\*A/W\*\*L Series Unit with CRV-F or ERV and No Ventilation with Balanced Climate**

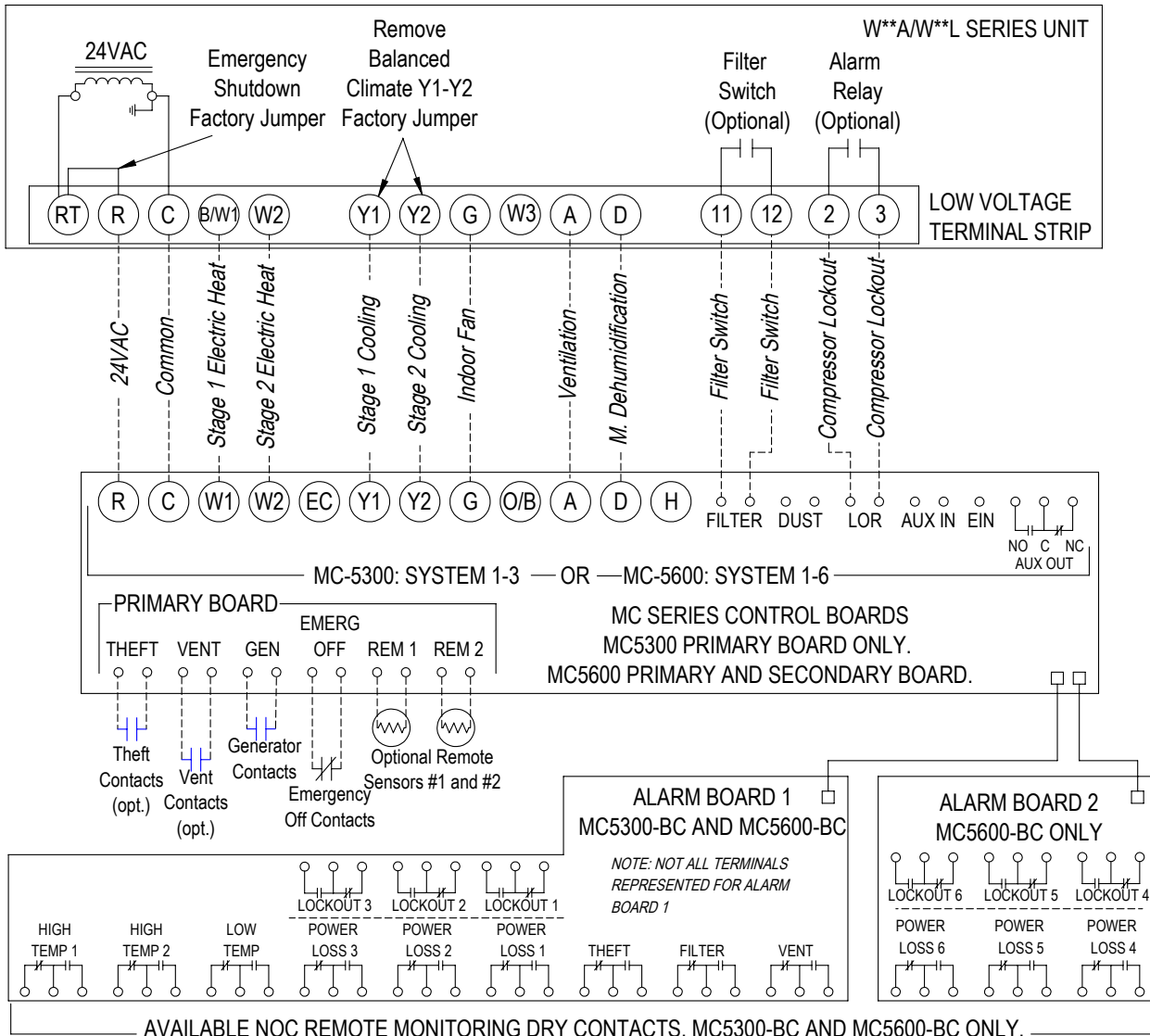

**Notes:**

- 1.) Stage 2 Electric Heat, Ventilation, Mechanical Dehumidification, and Filter Switch are optional components. Refer to model nomenclature to verify optional equipment installed in unit.
- 2.) Use VENT Contacts of Primary Board to activate ventilation using CO2 sensor or other peripheral device. Jumper VENT contacts for constant ventilation. Option must be used to activate "A" terminal with CRV-F and ERV ventilation options..
- 3.) Optional remote sensors #1 and #2 are temperature resistance 10k type 2. Remote sensor #2 can be used as an outdoor or indoor sensor.
- 4.) Emergency Off Contacts used in MC series controller to shut down all units. Emergency shutdown factory jumper may be removed to field install a normally closed relay at each individual unit.
- 5.) Balanced Climate factory jumper is removed for enhanced moisture removal during 1st stage of cooling. See unit installation manual and/or dehumidification supplemental instructions (units with mechanical dehumidification) for additional details regarding Balanced Climate mode of operation. Jumper can be reinstalled to disable Balanced Climate operation.
- 6.) All MC controllers will have a primary control board with connections for units 1 to 3. MC5600 controllers only will have an additional secondary control board with connections for units 4 to 6.
- 7.) MC5300-BC and MC5600-BC controllers have additional alarm board(s) with dry contacts for wired alarms.

MIS-4196 A

**FIGURE 21**  
**W\*\*A/W\*\*L Series Unit with Economizer**

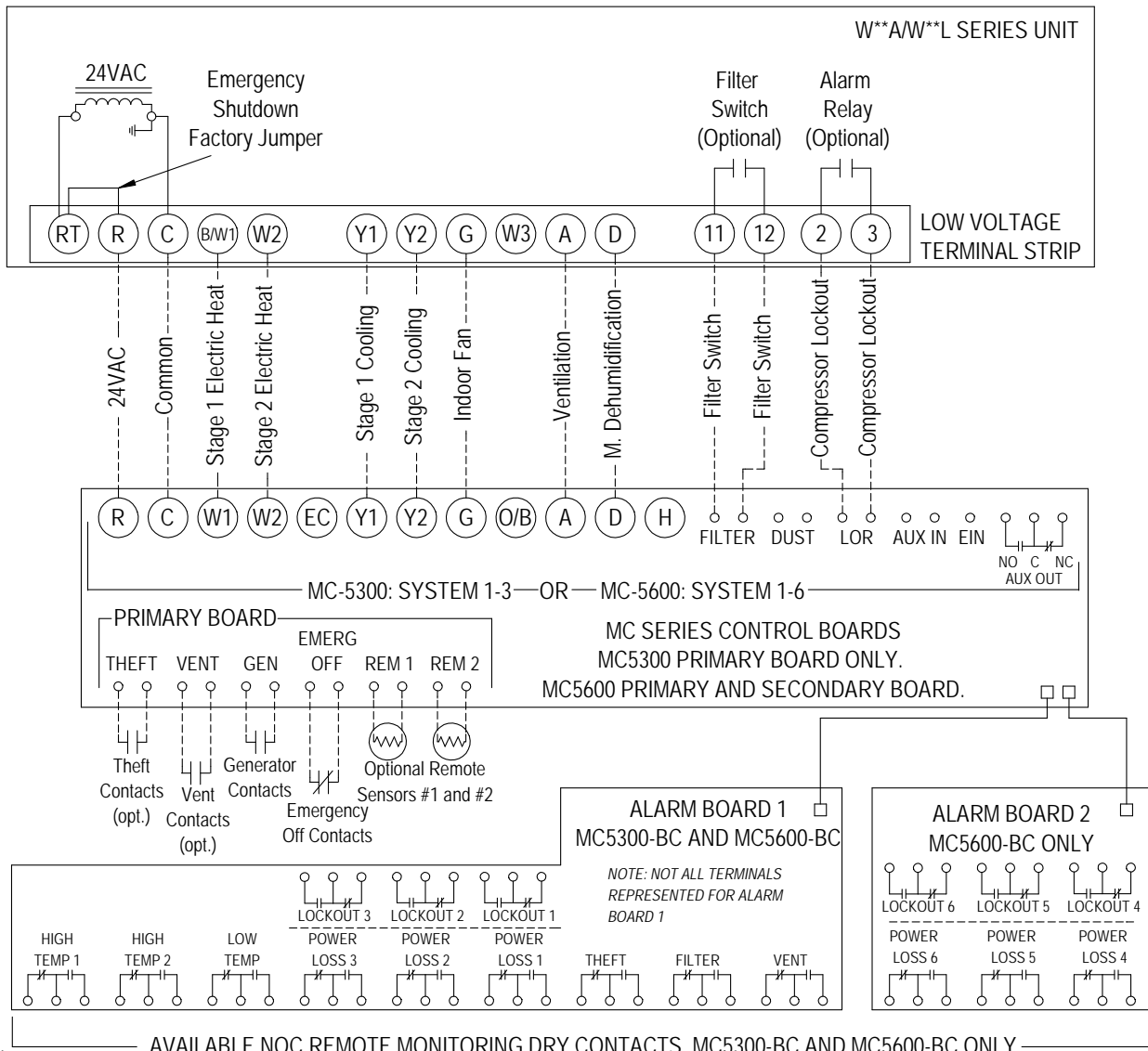

**Notes:**

- 1.) Stage 2 Electric Heat, Ventilation, Mechanical Dehumidification, and Filter Switch are optional components. Refer to model nomenclature to verify optional equipment installed in unit.
- 2.) Ventilation wire between "A" terminals allows for ventilation during a HIGH TEMP 2 alarm. Make sure to set min. position in WA series unit economizer JADE controller to 10V (fully open) to allow ventilation during a HIGH TEMP 2 alarm.
- 3.) Optional remote sensors #1 and #2 are temperature resistance 10k type 2. Remote sensor #2 can be used as an outdoor or indoor sensor.
- 4.) Emergency Off Contacts used in MC series controller to shut down all units. Emergency shutdown factory jumper may be removed to field install a normally closed relay at each individual unit.
- 5.) Units with economizers do not have a Balanced Climate factory installed brass jumper between Y1 and Y2. Please refer to vent manuals for instruction on how Balanced Climate works with each vent.
- 6.) All MC controllers will have a primary control board with connections for units 1 to 3. MC5600 controllers only will have an additional secondary control board with connections for units 4 to 6.
- 7.) MC5300-BC and MC5600-BC controllers have additional alarm board(s) with dry contacts for wired alarms.

MIS-4197 B

**FIGURE 22**  
**W\*\*H Series Unit with CRV-F or ERV and No Ventilation or Balanced Climate**

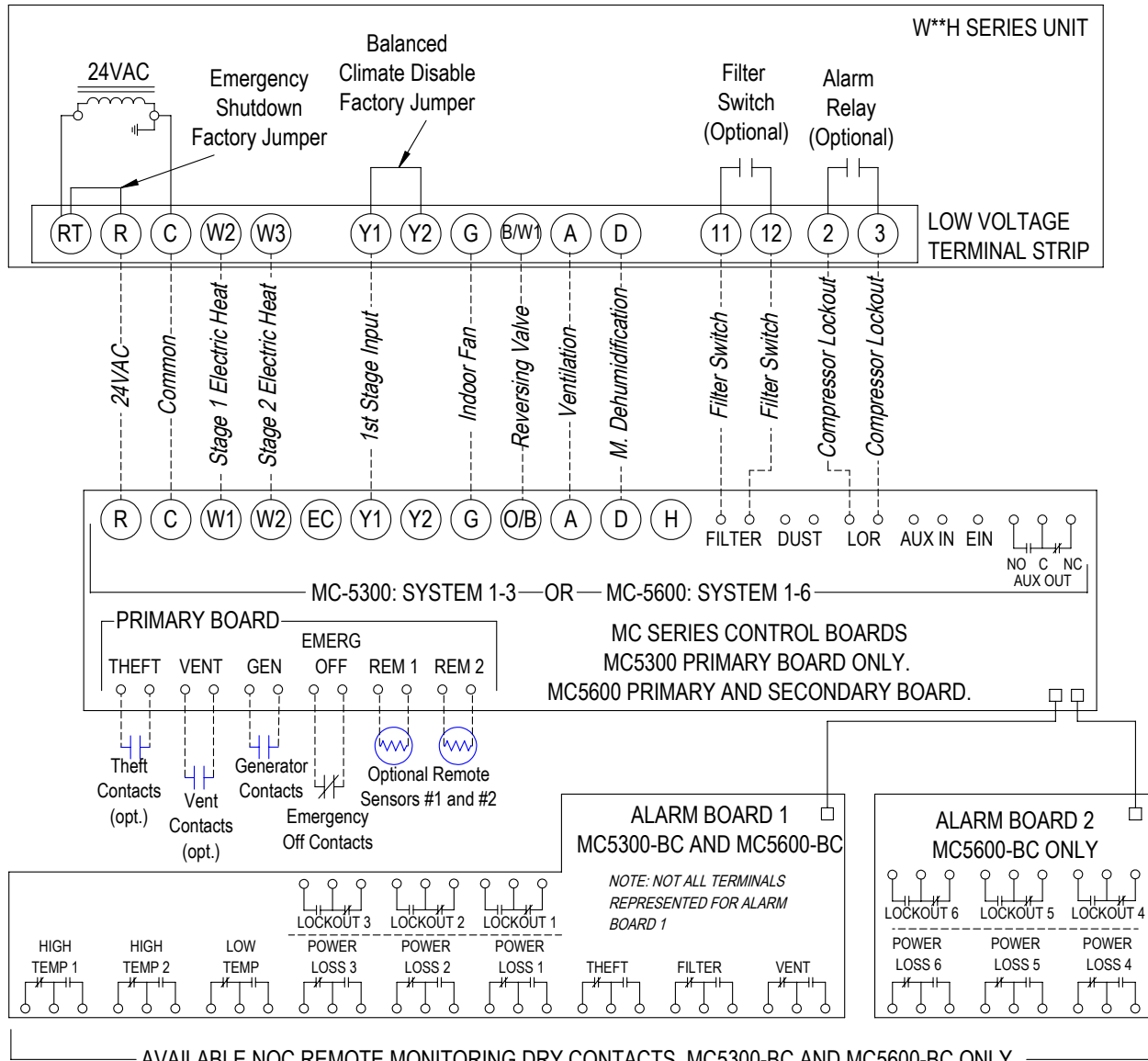

**Notes:**

- 1.) Stage 2 Electric Heat, Ventilation, Mechanical Dehumidification, and Filter Switch are optional components. Refer to model nomenclature to verify optional equipment installed in unit.
- 2.) Use VENT Contacts of Primary Board to activate ventilation using CO2 sensor or other peripheral device. Jumper VENT contacts for constant ventilation. Option must be used to activate "A" terminal with CRV-F and ERV ventilation options.
- 3.) Optional remote sensors #1 and #2 are temperature resistance 10k type 2. Remote sensor #2 can be used as an outdoor or indoor sensor.
- 4.) Emergency Off Contacts used in MC series controller to shut down all units. Emergency shutdown factory jumper may be removed to field install a normally closed relay at each individual unit.
- 5.) Balanced Climate factory jumper between Y1 and Y2 is not removed. See unit installation manual for additional details regarding Balanced Climate mode of operation.
- 6.) All MC controllers will have a primary control board with connections for units 1 to 3. MC5600 controllers only will have an additional secondary control board with connections for units 4 to 6.
- 7.) MC5300-BC and MC5600-BC controllers have additional alarm board(s) with dry contacts for wired alarms.

MIS-4199 A

**FIGURE 23**  
**W\*\*H Series Unit with CRV-F or ERV and No Ventilation with Balanced Climate**

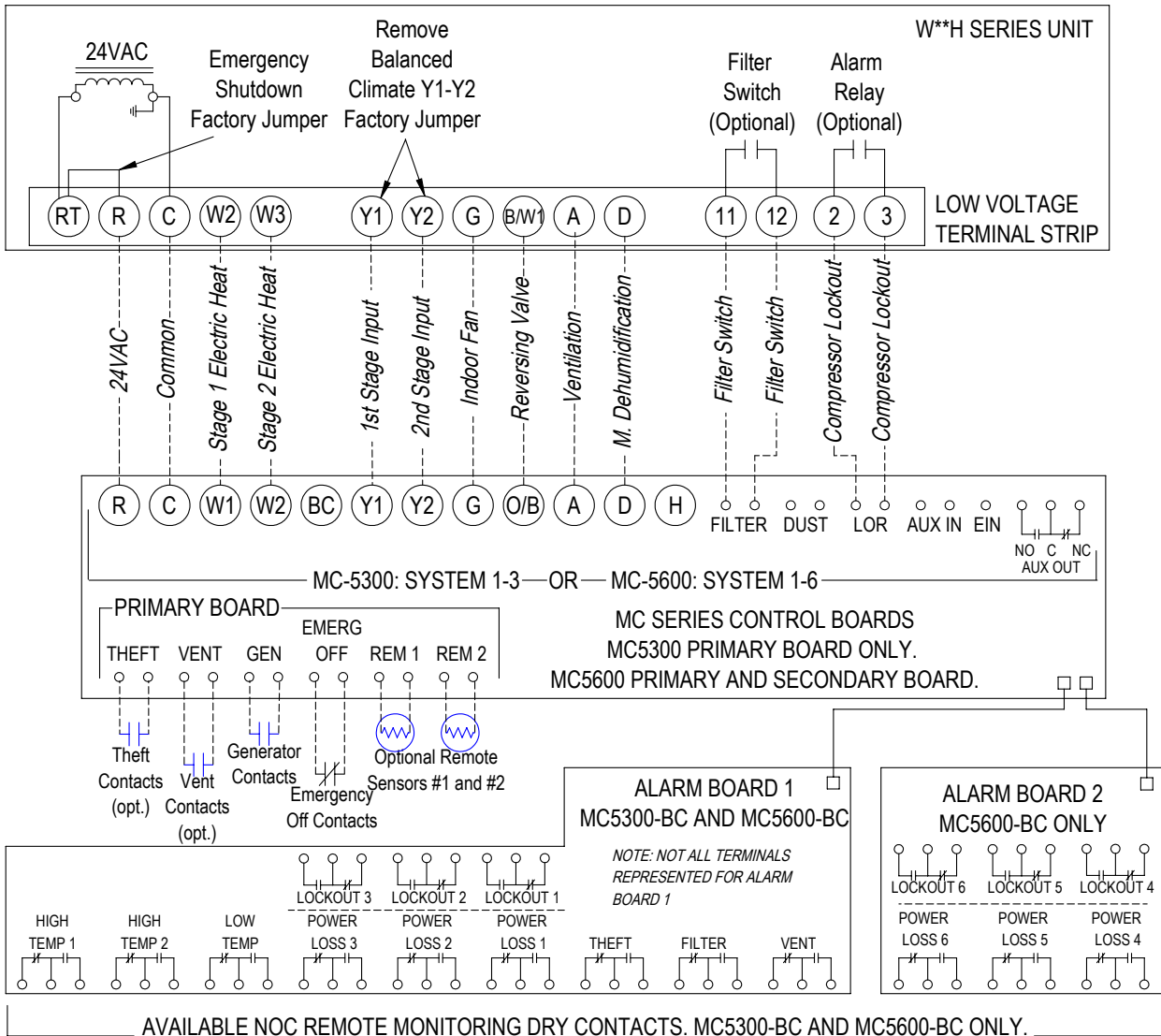

**Notes:**

- 1.) Stage 2 Electric Heat, Ventilation, Mechanical Dehumidification, and Filter Switch are optional components. Refer to model nomenclature to verify optional equipment installed in unit.
- 2.) Use VENT Contacts of Primary Board to activate ventilation using CO2 sensor or other peripheral device. Jumper VENT contacts for constant ventilation. Option must be used to activate "A" terminal with CRV-F and ERV ventilation options.
- 3.) Optional remote sensors #1 and #2 are temperature resistance 10k type 2. Remote sensor #2 can be used as an outdoor or indoor sensor.
- 4.) Emergency Off Contacts used in MC series controller to shut down all units. Emergency shutdown factory jumper may be removed to field install a normally closed relay at each individual unit.
- 5.) Balanced Climate factory jumper is removed for enhanced moisture removal during 1st stage of cooling. See unit installation manual and/or dehumidification supplemental instructions (units with mechanical dehumidification) for additional details regarding Balanced Climate mode of operation. Jumper can be reinstalled to disable Balanced Climate operation.
- 6.) All MC controllers will have a primary control board with connections for units 1 to 3. MC5600 controllers only will have an additional secondary control board with connections for units 4 to 6.
- 7.) MC5300-BC and MC5600-BC controllers have additional alarm board(s) with dry contacts for wired alarms.

MIS-4200 A

**FIGURE 24**  
**W\*\*H Series Unit with Economizer**

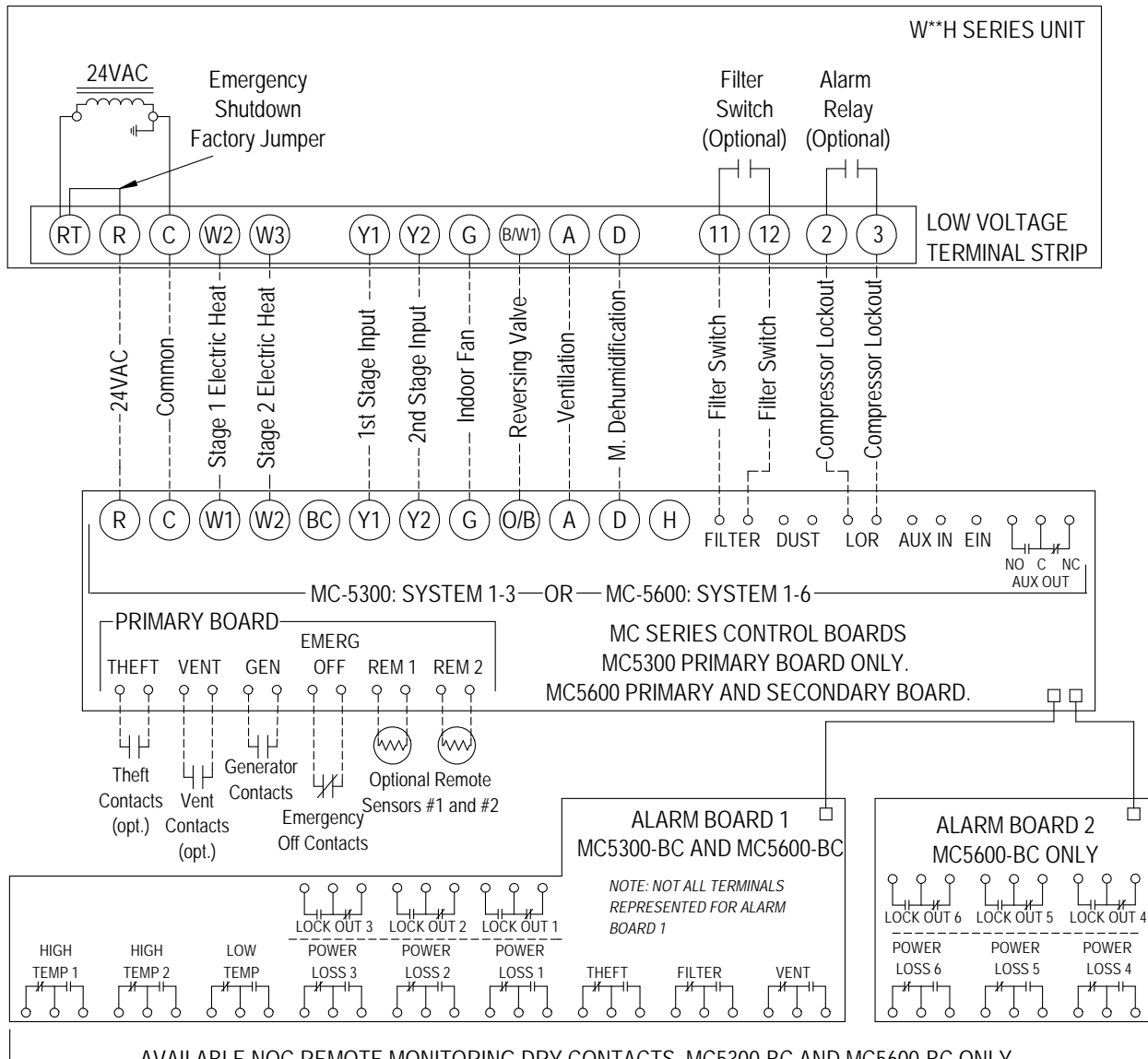

**Notes:**

- 1.) Stage 2 Electric Heat, Ventilation, Mechanical Dehumidification, and Filter Switch are optional components. Refer to model nomenclature to verify optional equipment installed in unit.
- 2.) Ventilation wire between "A" terminals allows for ventilation during a HIGH TEMP 2 alarm. Make sure to set min. position in WH series unit economizer JADE controller to 10V (fully open) to allow ventilation during a HIGH TEMP 2 alarm.
- 3.) Optional remote sensors #1 and #2 are temperature resistance 10k type 2. Remote sensor #2 can be used as an outdoor or indoor sensor.
- 4.) Emergency Off Contacts used in MC series controller to shut down all units. Emergency shutdown factory jumper may be removed to field install a normally closed relay at each individual unit.
- 5.) Units with economizers do not have a Balanced Climate factory installed brass jumper between Y1 and Y2. Please refer to vent manuals for instruction on how Balanced Climate works with each vent.
- 6.) All MC controllers will have a primary control board with connections for units 1 to 3. MC5600 controllers only will have an additional secondary control board with connections for units 4 to 6.
- 7.) MC5300-BC and MC5600-BC controllers have additional alarm board(s) with dry contacts for wired alarms.

MIS-4201 B



**FIGURE 25**  
**2-Stage W\*SA\* Series Unit with CRV-F or ERV and No Ventilation or Balanced Climate**

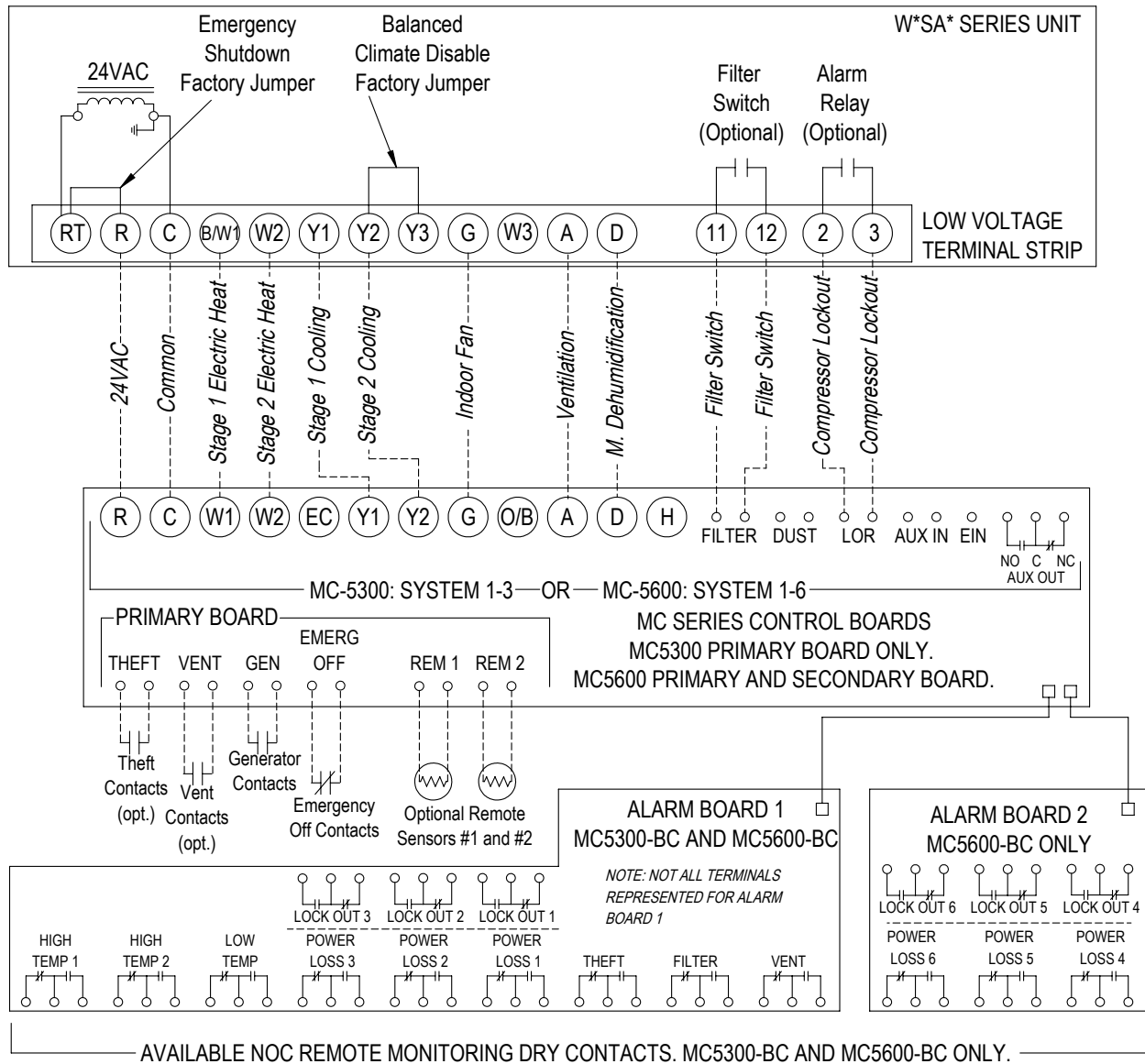

**Notes:**

- 1.) Stage 2 Electric Heat, Ventilation, Mechanical Dehumidification, and Filter Switch are optional components. Refer to model nomenclature to verify optional equipment installed in unit.
- 2.) Use VENT Contacts of Primary Board to activate ventilation using CO2 sensor or other peripheral device. Jumper VENT contacts for constant ventilation. Option must be used to activate "A" terminal with CRV-F and ERV ventilation options.
- 3.) Optional remote sensors #1 and #2 are temperature resistance 10k type 2. Remote sensor #2 can be used as an outdoor or indoor sensor.
- 4.) Emergency Off Contacts used in MC series controller to shut down all units. Emergency shutdown factory jumper may be removed to field install a normally closed relay at each individual unit.
- 5.) Balanced Climate factory jumper between Y2 and Y3 is not removed. See unit installation manual for additional details regarding Balanced Climate mode of operation.
- 6.) All MC controllers will have a primary control board with connections for units 1 to 3. MC5600 controllers only will have an additional secondary control board with connections for units 4 to 6.
- 7.) MC5300-BC and MC5600-BC controllers have additional alarm board(s) with dry contacts for wired alarms.

MIS-4207 A

**FIGURE 26**  
**2-Stage W\*SA\* Series Unit with ERV and Balanced Climate and No CRV-F or Ventilation**

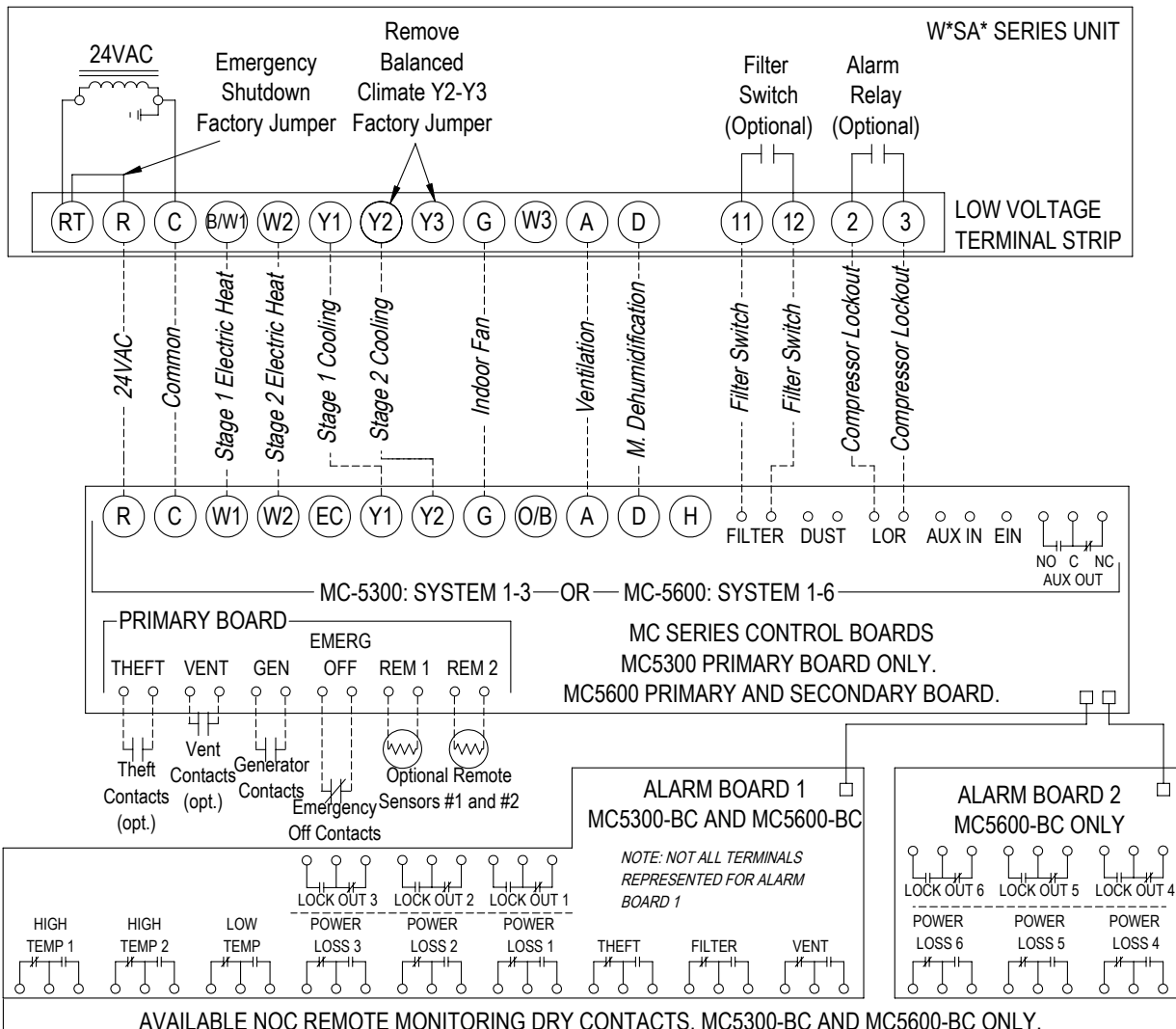

**Notes:**

- 1.) Stage 2 Electric Heat, Ventilation, Mechanical Dehumidification, and Filter Switch are optional components. Refer to model nomenclature to verify optional equipment installed in unit.
- 2.) Use VENT Contacts of Primary Board to activate ventilation using CO2 sensor or other peripheral device. Jumper VENT contacts for constant ventilation. Option must be used to activate "A" terminal with CRV-F and ERV ventilation options.
- 3.) Optional remote sensors #1 and #2 are temperature resistance 10k type 2. Remote sensor #2 can be used as an outdoor or indoor sensor.
- 4.) Emergency Off Contacts used in MC series controller to shut down all units. Emergency shutdown factory jumper may be removed to field install a normally closed relay at each individual unit.
- 5.) Balanced Climate factory jumper is removed from Y2 and Y3 for enhanced moisture removal during 2nd stage of cooling. See unit installation manual and/or dehumidification supplemental instructions (units with mechanical dehumidification) for additional details regarding Balanced Climate mode of operation. Jumper can be reinstalled between Y2 and Y3 to disable Balanced Climate operation. (If the unit has a CRV-F ventilation option, Balanced Climate will not be available. Avoid energizing Y3 if Balanced Climate is desired.)
- 6.) All MC controllers will have a primary control board with connections for units 1 to 3. MC5600 controllers only will have an additional secondary control board with connections for units 4 to 6.
- 7.) MC5300-BC and MC5600-BC controllers have additional alarm board(s) with dry contacts for wired alarms.

MIS-4208 A

**FIGURE 27**  
**2-Stage W\*SA\* Series Unit with Economizer**

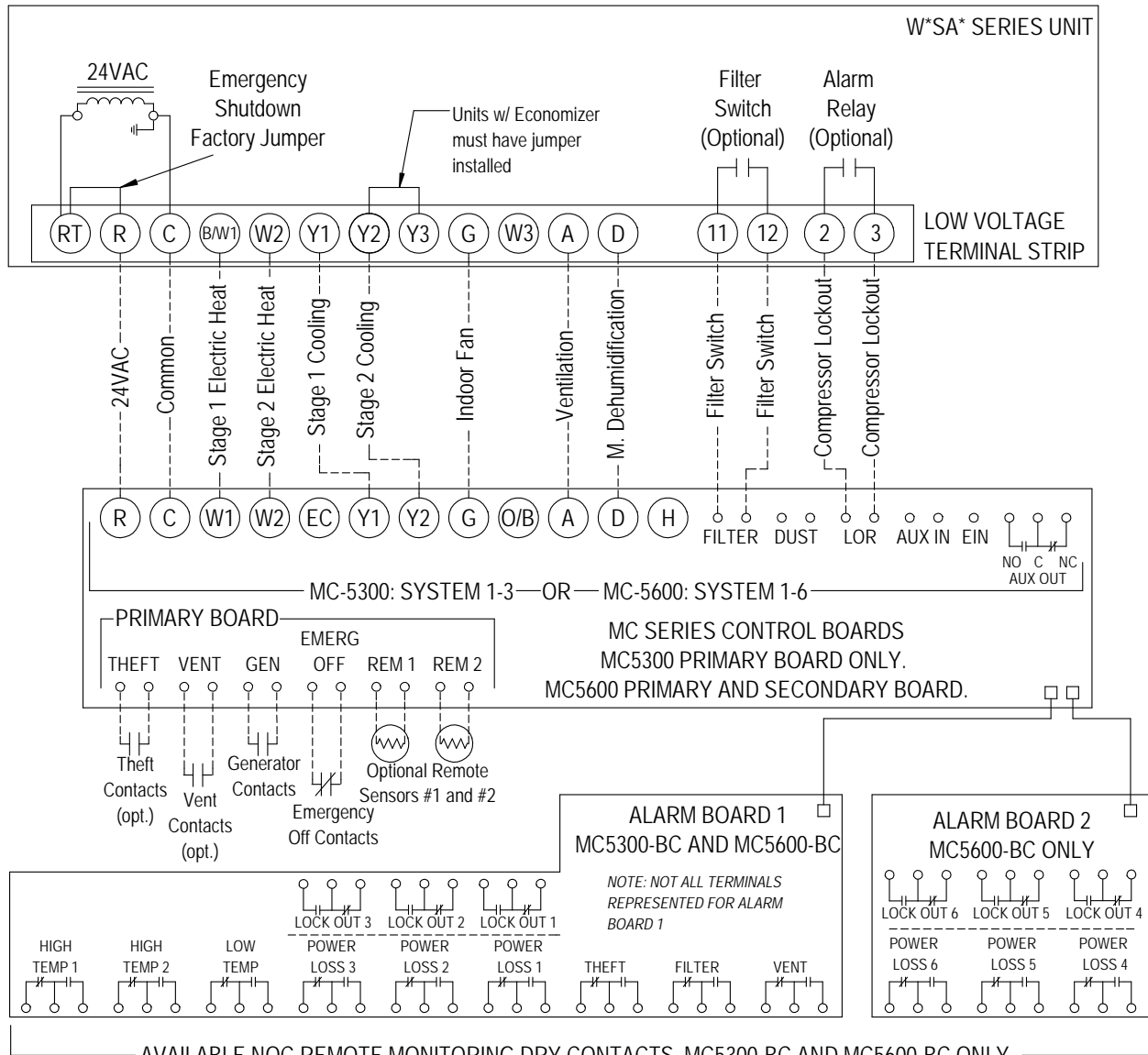

**Notes:**

- 1.) Stage 2 Electric Heat, Ventilation, Mechanical Dehumidification, and Filter Switch are optional components. Refer to model nomenclature to verify optional equipment installed in unit.
- 2.) Ventilation wire between "A" terminals allows for ventilation during a HIGH TEMP 2 alarm. Make sure to set min. position in WSAC series unit economizer JADE controller to 10V (fully open) to allow ventilation during a HIGH TEMP 2 alarm.
- 3.) Optional remote sensors #1 and #2 are temperature resistance 10k type 2. Remote sensor #2 can be used as an outdoor or indoor sensor.
- 4.) Emergency Off Contacts used in MC series controller to shut down all units. Emergency shutdown factory jumper may be removed to field install a normally closed relay at each individual unit.
- 5.) Balanced Climate is not available with economizer/CRV.
- 6.) All MC controllers will have a primary control board with connections for units 1 to 3. MC5600 controllers only will have an additional secondary control board with connections for units 4 to 6.
- 7.) MC5300-BC and MC5600-BC controllers have additional alarm board(s) with dry contacts for wired alarms.

MIS-4209 B

**FIGURE 28**  
**2-Stage T\*\*S Series Unit with No CRVMWH-\* or CHCRV-\***

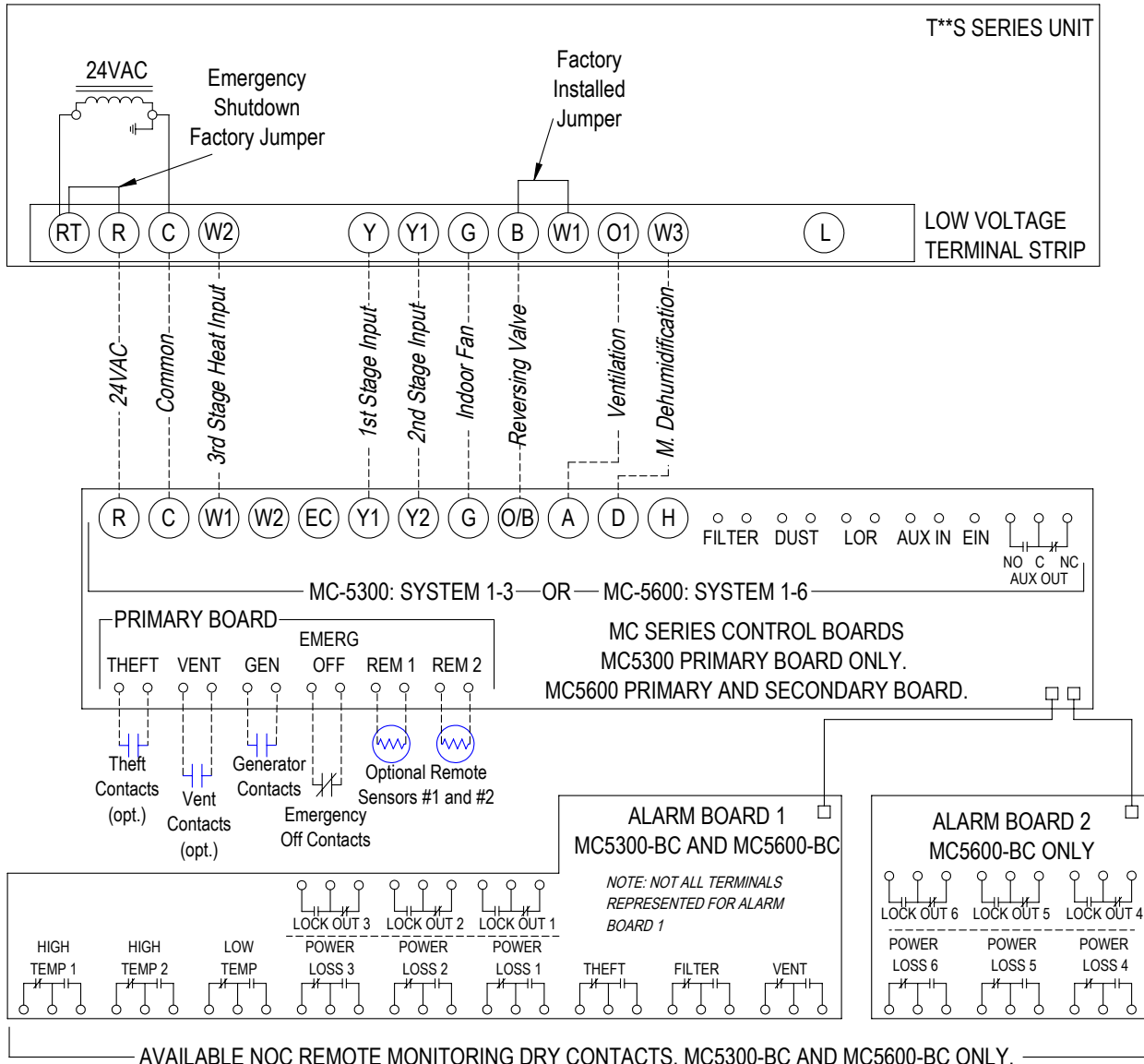

**Notes:**

- 1.) Stage 3 Heat Input (Electric Heat), Ventilation, and Mechanical Dehumidification optional components. Refer to model nomenclature to verify optional equipment installed in unit.
- 2.) Ventilation wire between the unit low voltage terminal "O1" and the "A" terminal on the MC board allows for energization of any factory installed ventilation or economizer option (Exception: *CRVMWH-\* and CHCRV-\* vent options not compatible with MC5000*). Use VENT Contacts of Primary Board to activate ventilation using CO2 sensor or other peripheral device. For constant ventilation, jumper VENT contacts.
- 3.) Optional remote sensors #1 and #2 are temperature resistance 10k type 2. Remote sensor #2 can be used as an outdoor or indoor sensor.
- 4.) Emergency Off Contacts used in MC series controller to shut down all units. Emergency shutdown factory jumper may be removed to field install a normally closed relay at each individual unit.
- 5.) All MC controllers will have a primary control board with connections for units 1 to 3. MC5600 controllers only will have an additional secondary control board with connections for units 4 to 6.
- 6.) MC5300-BC and MC5600-BC controllers have additional alarm board(s) with dry contacts for wired alarms.
- 7.) Compressor Lockout Output will not trigger the alarm on the display of the MC5000 controller (T\*\*S units).

MIS-4204

**FIGURE 29**  
**2-Stage C\*\*H Series Unit with No CRVMWH-\* or CHCRV-\***

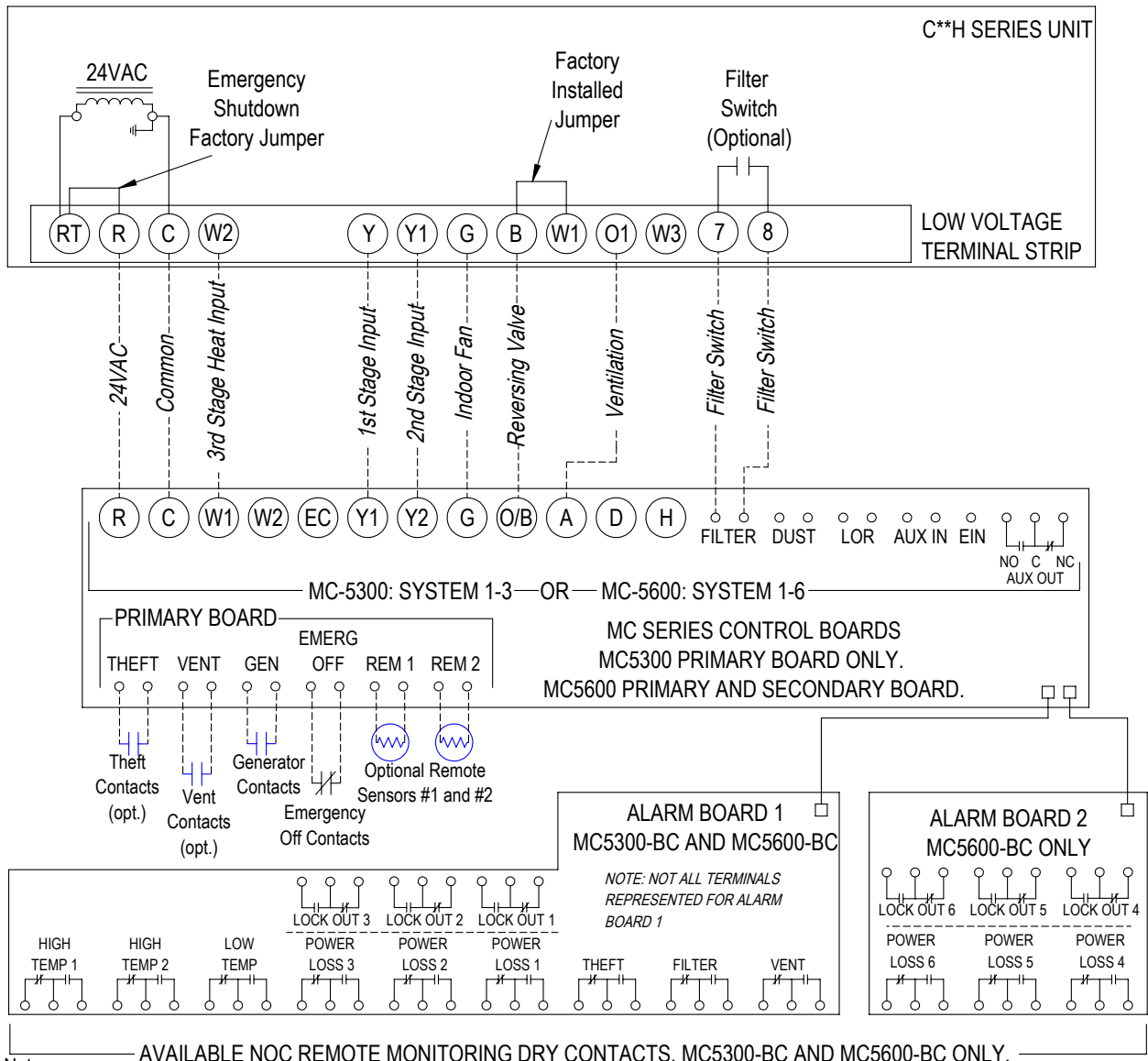

**Notes:**

- 1.) Stage 3 Heat Input (Electric Heat), Filter Switch, and Ventilation are optional components. Refer to model nomenclature to verify optional equipment installed in unit.
- 2.) Ventilation wire between the unit low voltage terminal "O1" and the "A" terminal on the MC board allows for energization of any factory installed ventilation or economizer option (Exception: *CRVMWH-\* and CHCRV-\* vent options not compatible with MC5000*). Use VENT Contacts of Primary Board to activate ventilation using CO2 sensor or other peripheral device. For constant ventilation, jumper VENT contacts.
- 3.) Optional remote sensors #1 and #2 are temperature resistance 10k type 2. Remote sensor #2 can be used as an outdoor or indoor sensor.
- 4.) Emergency Off Contacts used in MC series controller to shut down all units. Emergency shutdown factory jumper may be removed to field install a normally closed relay at each individual unit.
- 5.) All MC controllers will have a primary control board with connections for units 1 to 3. MC5600 controllers only will have an additional secondary control board with connections for units 4 to 6.
- 6.) MC5300-BC and MC5600-BC controllers have additional alarm board(s) with dry contacts for wired alarms.
- 7.) Compressor Lockout Output will not trigger the alarm on the display of the MC5000 controller (C\*\*H units).

MIS-4206

**FIGURE 30**  
**T\*\*H Series Unit with No CHCRV-\***

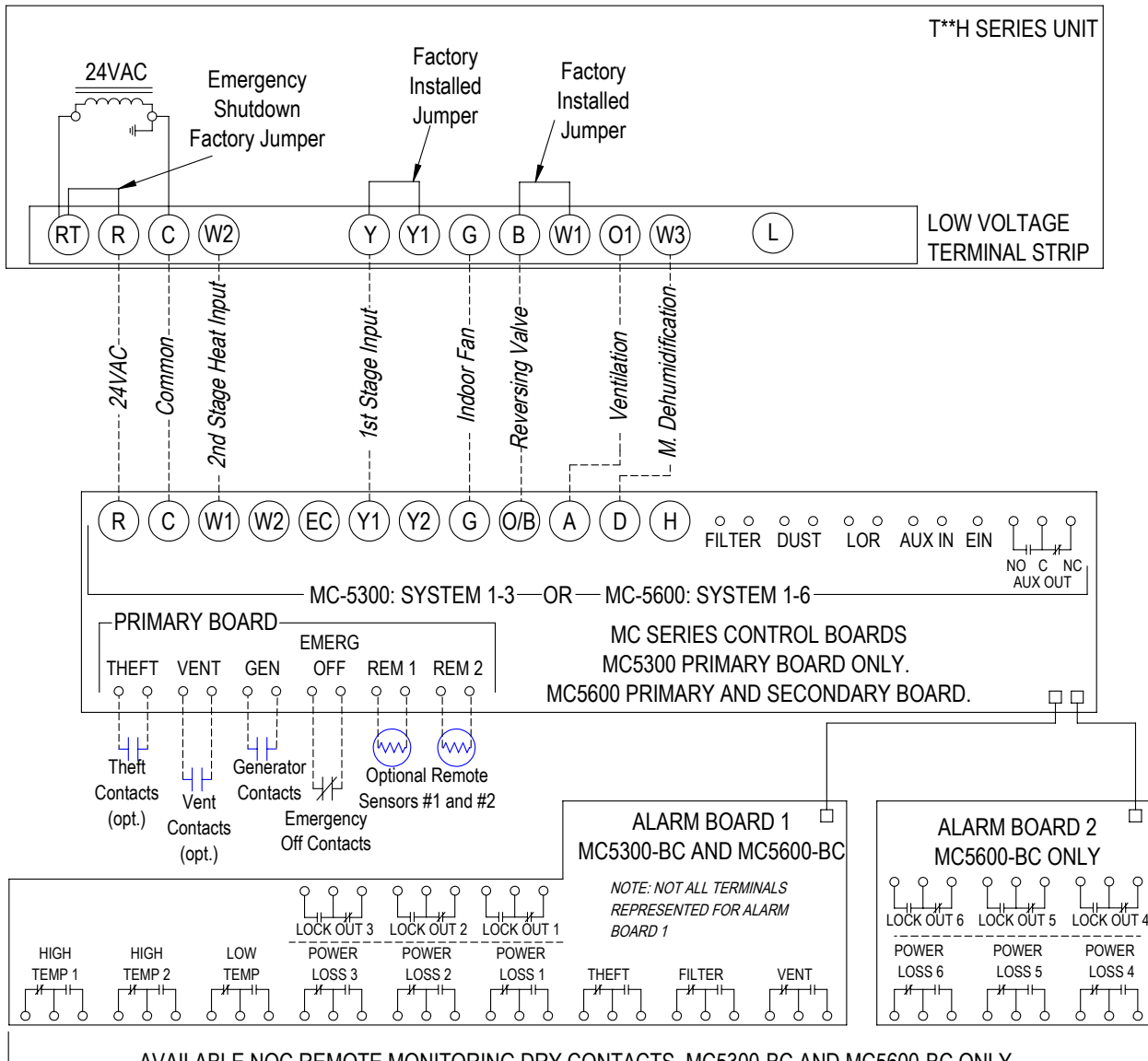

**Notes:**

- 1.) Stage 2 Heat Input (Electric Heat), Filter Switch, Ventilation, and Mechanical Dehumidification are optional features. Refer to model nomenclature to verify optional equipment installed in unit.
- 2.) Ventilation wire between the unit low voltage terminal "O1" and the "A" terminal on the MC board allows for energization of any factory installed ventilation or economizer option (Exception: *CHCRV-\** vent options not compatible with MC5000 controller). Use VENT Contacts of Primary Board to activate ventilation using CO2 sensor or other peripheral device. For constant ventilation, jumper VENT contacts.
- 3.) Optional remote sensors #1 and #2 are temperature resistance 10k type 2. Remote sensor #2 can be used as an outdoor or indoor sensor.
- 4.) Emergency Off Contacts used in MC series controller to shut down all units. Emergency shutdown factory jumper may be removed to field install a normally closed relay at each individual unit.
- 5.) All MC controllers will have a primary control board with connections for units 1 to 3. MC5600 controllers only will have an additional secondary control board with connections for units 4 to 6.
- 6.) MC5300-BC and MC5600-BC controllers have additional alarm board(s) with dry contacts for wired alarms.
- 7.) Compressor Lockout Output will not trigger the alarm on the display of the MC5000 controller (T\*\*H units).

MIS-4212

## Checking Remote (P/N 8408-061) or Local Temperature/Humidity Sensor (P/N 8408-059)

One local temperature/humidity sensor (P/N 8408-059) or remote temperature/humidity sensor (P/N 8408-061) can be used with the MC5000. These sensors are digital humidity sensors with an integrated temperature sensor that provides excellent measurement accuracy at very low power.

Because these sensors are digital, there is not a direct temperature measurement correlation that can be used for troubleshooting. Therefore, confirmation of an operational sensor is to be verified through observation that the red LED is ON.

1. With the system powered up, locate the sensor. For the local sensor (P/N 8408-059), the sensor will be located at the bottom of the MC5000 enclosure. If the remote sensor (P/N 8408-061) is being used, location may vary.
2. Make sure to verify the LED is illuminated RED as seen in Figure 31.
3. If the LED is not illuminated, make sure that the wires are connected to the Main Control Board (P/N 8612-066).
4. If the LED does not come ON after verification of the wire harness connection, a defective sensor may be the issue.

**FIGURE 31**  
Verifying Sensor LED Is Illuminated



LED will be visible through the slots of the local sensor cover. **NOTE:** This image shows local temperature/humidity sensor (P/N 8408-059) in the enclosure at the unit.

## Extreme Conditions

If the temperature/humidity sensor is exposed to extreme conditions (in excess of 158°F or below -40°F) for an extended amount of time, the RH offset may vary (up to  $\pm 4\%$ ).

## Airflow Across Remote Sensor (P/N 8408-061)

If the remote sensor is not mounted correctly, the humidity may not register accurately. Please verify that the sensor has sufficient airflow in its application (see Figure 32).

**FIGURE 32**  
Sufficient Airflow Across Remote Sensor

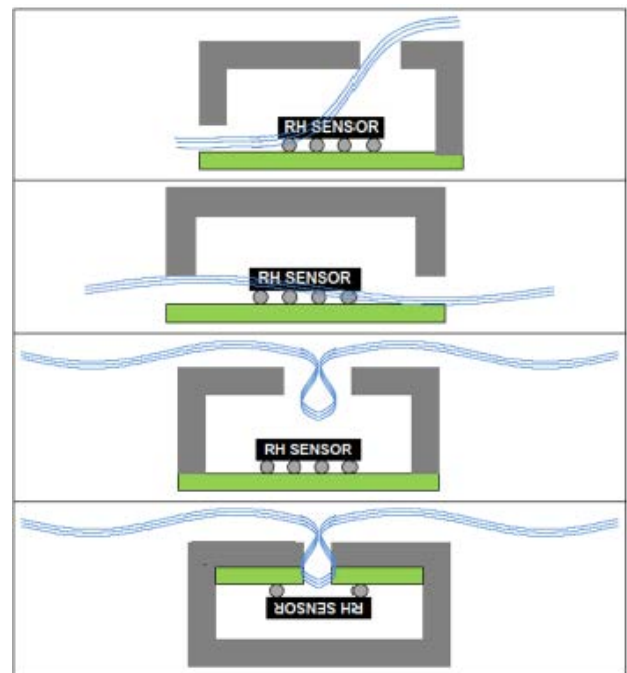

**NOTE:** Lines across the sensor in image are representative of airflow across sensor.

## Checking Remote Temperature Sensor (P/N 8301-095A) Outside Unit Circuit

1. Disconnect temperature sensor from board.
2. Use an ohmmeter to measure the resistance of the sensor. Also use ohmmeter to check for short or open.
3. Check resistance reading to chart of resistance. Use sensor ambient temperature. (Tolerance of part is  $\pm 1\%$ .)
4. If sensor resistance reads very low, sensor is shorted and will not allow proper control.
5. If sensor is out of tolerance, shorted, open or reads very low ohms, it should be replaced.

**TABLE 7**  
**10K OHM NTC Sensor: Temperature/Resistance**

Temperature			Resistance			Temperature			Resistance			Temperature			Resistance		
F	C	$\Omega$	F	C	$\Omega$	F	C	$\Omega$	F	C	$\Omega$	F	C	$\Omega$	F	C	$\Omega$
-40	-40	188,500	24.8	-4	32,440	89.6	32	7,730	154.4	68	2,360						
-38.2	-39	178,500	26.6	-3	31,050	91.4	33	7,450	156.2	69	2,300						
-36.4	-38	169,000	28.4	-2	29,730	93.2	34	7,190	158	70	2,230						
-34.6	-37	160,200	30.2	-1	28,480	95	35	6,940	159.8	71	2,160						
-32.8	-36	151,900	32	0	27,280	96.8	36	6,700	161.6	72	2,100						
-31	-35	144,100	33.8	1	26,130	98.6	37	6,470	163.4	73	2,040						
-29.2	-34	136,700	35.6	2	25,030	100.4	38	6,250	165.2	74	1,980						
-27.4	-33	129,800	37.4	3	23,990	102.2	39	6,030	167	75	1,920						
-25.6	-32	123,300	39.2	4	23,000	104	40	5,830	168.8	76	1,870						
-23.8	-31	117,100	41	5	22,050	105.8	41	5,630	170.6	77	1,820						
-22	-30	111,300	42.8	6	21,150	107.6	42	5,440	172.4	78	1,770						
-20.2	-29	105,700	44.6	7	20,300	109.4	43	5,260	174.2	79	1,920						
-18.4	-28	100,500	46.4	8	19,480	111.2	44	5,080	176	80	1,670						
-16.6	-27	95,520	48.2	9	18,700	113	45	4,910	177.8	81	1,620						
-14.8	-26	90,840	50	10	17,960	114.8	46	4,750	179.6	82	1,580						
-13	-25	86,430	51.8	11	17,240	116.6	47	4,590	181.4	83	1,530						
-11.2	-24	82,260	53.6	12	16,560	118.4	48	4,440	183.2	84	1,490						
-9.4	-23	78,330	55.4	13	15,900	120.2	49	4,300	185	85	1,450						
-7.6	-22	74,610	57.2	14	15,280	122	50	4,160	186.8	86	1,441						
-5.8	-21	71,100	59	15	14,690	123.8	51	4,030	188.6	87	1,370						
-4	-20	67,770	60.8	16	14,120	125.6	52	3,900	190.4	88	1,340						
-2.2	-19	64,570	62.6	17	13,580	127.4	53	3,770	192.2	89	1,300						
-0.4	-18	61,540	64.4	18	13,060	129.2	54	3,650	194	90	1,270						
1.4	-17	58,680	66.2	19	12,560	131	55	3,540	195.8	91	1,230						
3.2	-16	55,970	68	20	12,090	132.8	56	3,430	197.6	92	1,200						
5	-15	53,410	69.8	21	11,630	134.6	57	3,320	199.4	93	1,170						
6.8	-14	50,980	71.6	22	11,200	136.4	58	3,220	201.2	94	1,140						
8.6	-13	48,680	73.4	23	10,780	138.2	59	3,120	203	95	1,110						
10.4	-12	46,500	75.2	24	10,380	140	60	3,020	204.8	96	1,080						
12.2	-11	44,430	77	25	10,000	141.8	61	2,930	206.6	97	1,050						
14	-10	42,470	78.8	26	9,630	143.6	62	2,840	208.4	98	1,020						
15.8	-9	40,570	80.6	27	9,280	145.4	63	2,750	210.2	99	1,000						
17.6	-8	38,770	82.4	28	8,940	147.2	64	2,670	212	100	970						
19.4	-7	37,060	84.2	29	8,620	149	65	2,590									
21.2	-6	35,440	86	30	8,310	150.8	66	2,510									
23	-5	33,900	87.8	31	8,010	152.6	67	2,440									



## Troubleshooting Alarms

Low Temp Alarm	This alarm indicates that there is a lower space temperature than is desired. The space temperature should be verified and compared to the controller reading. If the space temperature reading is incorrect ensure there is no offset applied and then the wiring to the temperature sensors installed should be verified. If wiring is verified and sensor reading is still low then sensor replacement may be required. If the space temperature is low then a heating unit malfunction or inadequate heating capacity should be investigated.
High Temp Alarm 1	This alarm indicates that the space temperature has risen higher than desired. The space temperature should be verified and compared to the controller reading. If the space temperature reading is incorrect ensure there is no offset applied and then the wiring to the temperature sensors installed should be verified. If wiring is verified and sensor reading is still high then sensor replacement may be required. If the space temperature is proven to be higher than desired malfunction of the cooling equipment or lack of cooling capacity should be investigated.
High Temp Alarm 2	This alarm indicates that the space temperature has risen higher than desired. The space temperature should be verified and compared to the controller reading. If the space temperature reading is incorrect ensure there is no offset applied and then the wiring to the temperature sensors installed should be verified. If wiring is verified and sensor reading is still high then sensor replacement may be required. If the space temperature is proven to be higher than desired malfunction of the cooling equipment or lack of cooling capacity should be investigated.
Emergency Off Alarm	This alarm indicates that the continuity between the Emergency Off inputs has been broken. The function of the device connected to the Emergency Off inputs should be verified first. If all device functionality is correct and the alarm is still present the wiring between the device and controller should be checked. Prior to replacing the I/O board all wiring should be removed from the Emergency Off inputs and replaced with a jumper. This should clear the alarm if the board and software are functioning properly.
Generator Run Alarm	This alarm indicates that the Generator Run inputs have continuity. The function of the device connected to the Generator Run inputs should be verified first. If all device functionality is correct and the alarm is still present the wiring between the device and controller should be checked. Prior to replacing the I/O board all wiring should be removed from the Generator Run inputs. This should clear the alarm if the board and software are functioning properly.
Service Alarm (Units 1-6)	This alarm indicates that the Filter inputs for the unit indicated have continuity. The function of the device connected to the Filter inputs should be verified first. If all device functionality is correct and the alarm is still present the wiring between the device and controller should be checked. Prior to replacing the I/O board all wiring should be removed from the Filter inputs. This should clear the alarm if the board and software are functioning properly.
Theft Alarm	This alarm indicates that the Theft inputs have continuity. The function of the device connected to the Theft inputs should be verified first. If all device functionality is correct and the alarm is still present the wiring between the device and controller should be checked. Prior to replacing the I/O board all wiring should be removed from the Theft inputs. This should clear the alarm if the board and software are functioning

Ventilation Alarm	This alarm indicates that the Vent inputs have continuity. The function of the device connected to the Vent inputs should be verified first. If all device functionality is correct and the alarm is still present the wiring between the device and controller should be checked. Prior to replacing the I/O board all wiring should be removed from the Vent inputs. This should clear the alarm if the board and software are functioning properly.
Power Loss Alarm (Units 1-6)	This alarm indicates that control voltage (24vac) is not detected for the unit indicated. Voltage should be verified at R-C for the unit specified. If not present wiring and control voltage at the unit should be verified. If 18-24vac is present at R-C for the unit indicated the I/O board may be damaged.
Compressor Lockout Alarm (Units 1-6)	This alarm indicates that the LOR inputs for the unit indicated have continuity. The function of the device connected to the LOR inputs should be verified first. If all device functionality is correct and the alarm is still present the wiring between the device and controller should be checked. Prior to replacing the I/O board all wiring should be removed from the LOR inputs. This should clear the alarm if the board and software are functioning properly.
HVAC Dust Alarm (Units 1-6)	This alarm indicates that the Dust inputs for the unit indicated have continuity. The function of the device connected to the Dust inputs should be verified first. If all device functionality is correct and the alarm is still present the wiring between the device and controller should be checked. Prior to replacing the I/O board all wiring should be removed from the Dust inputs. This should clear the alarm if the board and software are functioning properly.
Hum/Temp Sensor Not Connected	This alarm indicates that the HUM/TEMP sensor is not connected. The 4 pin terminal labeled HUM/TEMP should be checked to make sure it is seated properly and continuity of wiring to sensor should be checked prior to replacement of sensor or I/O board.
High Humidity Alarm	This alarm indicates that the space humidity has risen higher than desired. The space humidity should be verified and compared to the controller reading. If the space humidity reading is incorrect ensure there is no offset applied and then the wiring to the humidity sensor should be verified. If wiring is verified and sensor reading is still high sensor replacement may be required. If the space humidity is proven to be higher than desired malfunction of the dehumidification equipment or lack of dehumidification capacity should be investigated.
Low Humidity Alarm	This alarm indicates that the space humidity is lower than desired. The space humidity should be verified and compared to the controller reading. If the space humidity reading is incorrect ensure there is no offset applied and then the wiring to the humidity sensor should be verified. If wiring is verified and sensor reading is still low then sensor replacement may be required. If the space humidity is proven to be lower than desired malfunction of the humidification equipment or lack of humidification capacity should be investigated.

# MC5000 SERIES CONTROLLER REPLACEMENT PARTS LIST

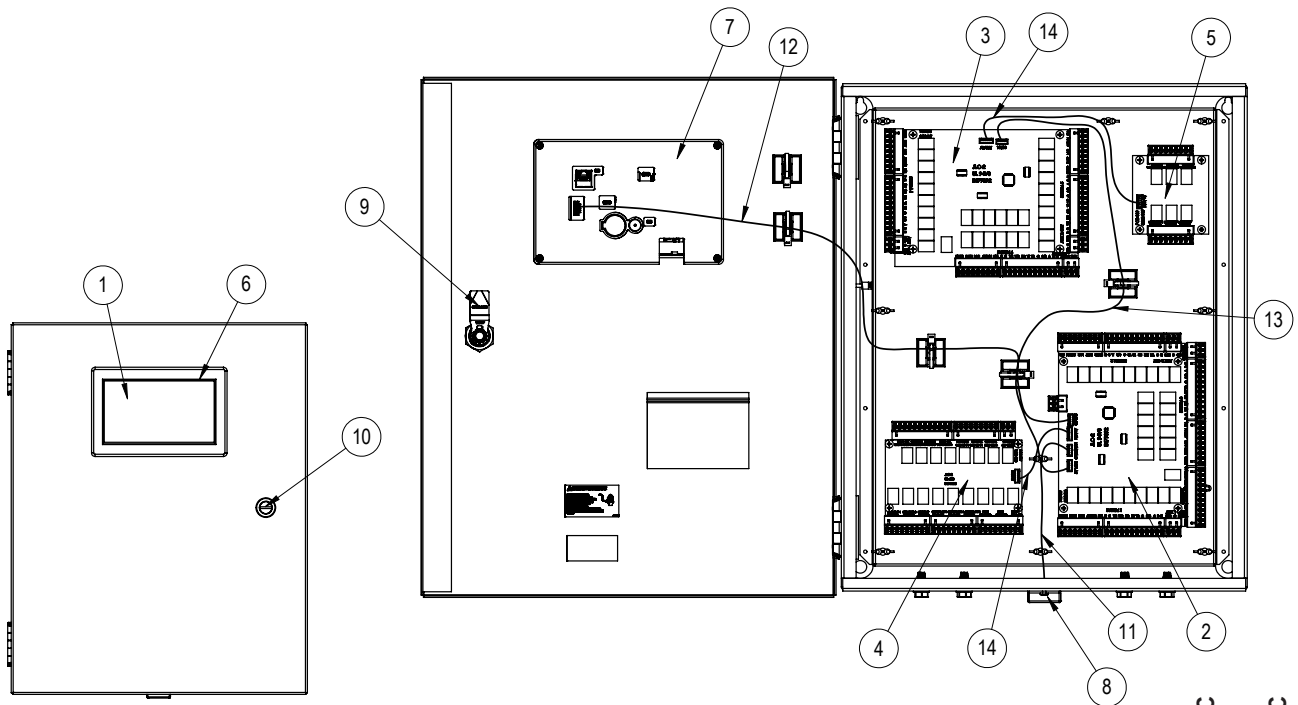

Dwg. No.	Part No.	Description	MC5300-C	MC5300-BC	MC5600-C	MC5600-BC
1	8612-065	Display Board w/Ethernet <sup>1</sup>	X	X	X	X
2	8612-066	Main I-O Board	X	X	X	X
3	8612-067	Secondary I-O Board			X	X
4	8612-068A	Main Alarm Board		X		X
5	8612-069	Secondary Alarm Board				X
6	8301-092	Bezel Front	X	X	X	X
7	8301-093	Bezel Back	X	X	X	X
8	8301-094	Cover for Temperature/Humidity Sensor	X	X	X	X
9	1171-073	1/4 Turn Latch Cam	X	X	X	X
10	1171-074	1/4 Turn Latch	X	X	X	X
11	8408-059A	Temperature/Humidity Sensor w/11" Cable	X	X	X	X
12	3020-026A	36" Cable for Display to I-O	X	X	X	X
13	3020-024A	18" Cable for Secondary I-O			X	X
14	3020-025A	11" Cable for Alarm Board		X		2
NS	8611-269	Snap-in Standoff - Nylon (PCB Retainer)	4	8	12	16
NS	8611-262	3-Pole Card Slot Terminal Block	3	4	6	7
NS	8611-263	9-Pole Card Slot Terminal Block	3	7	6	10
NS	8611-264	12-Pole Card Slot Terminal Block	4	5	7	8
NS	8301-100	MicroSD Card <sup>2</sup>	X	X	X	X
NS	8408-061	Indoor Temperature/Humidity Sensor w/35' Cable (Optional-Used in place of 8408-059)	X	X	X	X
NS	8301-095A	Indoor/Outdoor Temperature Only Sensor w/35' Cable (Optional)	X	X	X	X
NS	8620-321	Main Alarm Board Upgrade Kit, includes 8612-068A Main Alarm Board, 11" Cable and Mounting Hardware (Optional)	X		X	
NS	8620-322	Secondary I/O Board Upgrade Kit, includes 8612-067 Secondary I/O Board, 18" Cable and Mounting Hardware (Optional)	X	X		
NS	8620-323	Secondary Alarm Board Upgrade Kit, includes 8612-069 Secondary Alarm Board, 11" Cable and Mounting Hardware (Optional)	X	X	X	

NS = Not Shown

<sup>1</sup> Batteries for control boards are field supplied (supplier part number CR2032).

<sup>2</sup> Replacement MicroSD cards do not contain firmware.