INSTALLATION INSTRUCTIONS

Partial Flow Economizer with Exhaust for Building Applications

Factory-Installed Vent Option
with Enthalpy Outdoor Control

For Use with Bard Q-TEC Models:

Q24H4-A	Q30H4-A	Q36H4-A	Q43H4-A	Q48H4-A
Q24H4-B	Q30H4-B	Q36H4-B	Q43H4-B	Q48H4-B
Q24H4-C	Q30H4-C	Q36H4-C	Q43H4-C	Q48H4-C
Q24H4DA	Q30H4DA	Q36H4DA	Q43H4DA	Q48H4DA
Q24H4DB	Q30H4DB	Q36H4DB	Q43H4DB	Q48H4DB
Q24H4DC	Q30H4DC	Q36H4DC	Q43H4DC	Q48H4DC
		Q36A4DA	Q42A4DA	Q48A4DA
		Q36A4DB	Q42A4DB	Q48A4DB
		Q36A4DC	Q42A4DC	Q48A4DC



Bard Manufacturing Company, Inc.
Bryan, Ohio 43506
www.bardhvac.com

Manual : 2100-743B
Supersedes: 2100-743A
Date: 7-6-22

Climate Control Solutions

CONTENTS

GENERAL.....	3
Overview	3
JADE Features.....	3
Economizer Maintenance	3
Control Wiring Connection Diagrams.....	4
START-UP/CHECKOUT PROCEDURES	8
JADE™ Economizer Controller	8
Review/Customize System Setup.....	8
Enthalpy Settings	12
Economizer Sequence of Operation	13
Condition – Cool/Dry OA Conditions.....	13
Condition – Warm/Humid OA Conditions	13
Economizer Operation for Single Stage	15
Balanced Climate Mode – S, Y and Z Option	
Economizer Sequence of Operation	16
Economizer Operation – Balanced Climate Mode ..	17



WARNING

Exposed moving parts.

Disconnect electrical power before servicing.

Failure to do so could result in severe injury or amputation.

FIGURES

Figure 1	Programmable Thermostat Connections for Heat Pump with Economizer	4
Figure 2	Non-Programmable Thermostat Connections for Heat Pump with Economizer	5
Figure 3	Programmable Thermostat Connections for Air Conditioner with Economizer	6
Figure 4	Non-Programmable Thermostat Connections for Air Conditioner with Economizer	7
Figure 5	JADE™ Economizer Controller	8
Figure 6	100% Outside Airflow Path	13
Figure 7	Mixed Airflow Path	13
Figure 8	100% Closed Loop Airflow Path	14
Figure 9	CO ₂ Sensor Default and Final Settings Bard Part #8403-096 CO ₂ Controller	18
Figure 10	Wiring Diagram – Enthalpy Sensor	22

TABLES

Table 1	System Setup Menu Levels	9
Table 2	Advanced Setup Menu Levels.....	9
Table 3	Setpoints Menu Levels.....	10
Table 4	Checkout Menu Levels.....	10
Table 5	Status Menu Levels.....	11
Table 6	Alarm Examples	11
Table 7	Unit Operation with S (Part Flow) Economizer Options	16

GRAPHS

Graph 1	Q24H4 Economizer Ventilation Delivery ..	19
Graph 2	Q30H4 Economizer Ventilation Delivery ..	19
Graph 3	Q36H4 Economizer Ventilation Delivery ..	20
Graph 4	Q43H4 Economizer Ventilation Delivery ..	20
Graph 5	Q48H4 Economizer Ventilation Delivery ..	21

Economizer Features

- One piece construction. Direct-drive actuator eliminates linkage.
- Exhaust air damper—built in with positive closed position. Provides exhaust air capability to prevent pressurization of tight buildings.
- JADE™ controller provides nearly limitless customization on a solid, intuitive electronic platform.
- Actuator Motor – 24 volt, power-open, spring-return, direct-coupled with stall protection. Self-centering shaft clamp and access cover facilitate ease of replacement/maintenance.
- Proportioning-type control utilizes outdoor air for “free” cooling economy and comfort.
- Enthalpy sensor to monitor outdoor air conditions.
- Minimum Ventilation Position available for required ventilation of occupants or dilution of pollutants.
- Mixed air sensor to monitor outdoor and return air to automatically modulate damper position.

Overview

The Q-TEC partial flow economizer is designed to provide free cooling to an indoor space by bringing in outdoor air when conditions are acceptable. The economizer includes a JADE™ controller which monitors outdoor conditions including both outdoor temperature and humidity (enthalpy) and decides if outdoor air can be brought into the room to provide cooling. If conditions are unacceptable, the JADE will not bring in outdoor air to cool the room and will use the refrigeration circuit (compressor) to provide cooling. The JADE controller communicates to a motor that operates a single damper blade. As the blade opens, cooler intake air is brought into the room and warmer exhaust air leaves the room. The JADE monitors the temperature of the mixed outdoor air entering the unit and the room air entering the return opening. The blade modulates to maintain a mixed air temperature per the settings in the JADE controller. Minimum blade position allows for ventilation air to be brought into a room or structure for occupants.

JADE Features

Settings are provided through the use of a touchpad and LCD display located on the JADE controller inside the ventilation section of the unit. Several features and options are available through the JADE interface including the following: Status, Setpoints, System Setup, Advanced Setup, Checkout and Alarms. Standard settings that cover many applications are pre-programmed into the JADE controller and Bard recommends not adjusting settings in the Setup and Advanced Setup menu without advanced knowledge of the Q-TEC product. The Setpoints menu includes an enthalpy curve selection feature that can be adjusted to increase or decrease economizer operational time by setting different parameters for acceptable outdoor conditions. Bard default enthalpy curve settings provide optimal run time for standard applications. A lower enthalpy setting will reduce economizing time and a higher setting will increase economizing time. Avoid high enthalpy curve settings in areas with high outdoor humidity levels. Minimum blade position can also be set (see below). It is important to use the Bard default recommended mixed air temperature setting for normal application operation. Lower mixed air settings may allow evaporator coil temperatures below freezing, causing ice to build up on the evaporator coil. Higher mixed air settings may reduce economizer energy efficiency and also reduce the ability of the unit to cool the room.

The JADE controller has the ability to provide a minimum ventilation amount for rooms when they are occupied. Minimum position is set using the touchpad and LCD display on the JADE controller. Minimum position can be activated using several different methods;

- Ventilate when the thermostat calls for indoor fan operation. Ventilation will either be on or off based on this signal.
- Use a thermostat or separately mounted motion sensor, CO₂ sensor or schedule to provide ventilation. Ventilation will either be on or off based on this signal.
- Connect a thermostat or separately mounted CO₂ sensor with a 0-10V output signal. Ventilation will modulate based on this signal.

If non-modulating on/off ventilation is used (no 0-10V signal), minimum blade position settings must be used that allow the needed amount of outdoor air intake but do not over ventilate causing uncomfortable conditions in the room. Review building codes and also the ventilation setting charts in this manual for setting minimum blade position voltage in the JADE controller. Be sure to review all instructions provided with the thermostat and/or other controllers regarding ventilation operation that may be available. Instructions are provided in this manual to give an overview of how several Bard thermostats may be connected to the Q-TEC unit with the partial flow economizer option. User-supplied thermostats must be reviewed to ensure they can be used to provide cooling and ventilation operation per building design specifications.

Economizer Maintenance

The Q-TEC partial flow economizer is designed for minimal maintenance procedures during the life of the product. Bard recommends cleaning the coarse filter located in the sleeve area annually and this can be done along with condenser coil cleaning maintenance. Linkage should be inspected on a regular basis and the Checkout feature in the JADE menu may be used to operate the economizer damper assembly. Follow all safety instructions provided in the unit manual. Replace damaged parts if necessary and a dry lubricant such as Moli-Spray #3 may be used on parts that are starting to show signs of wear.

Control Wiring Connection Diagrams

The control wiring diagrams in Figures 1, 2, 3 and 4 represent typical control wiring for single units controlled by individual thermostats. If thermostats other than those referenced are used, the installer must verify output functions accordingly.

For dual unit installation utilizing lead/lag controller systems, complete details are contained in MC4002 Series Lead/Lag Controller installation manual 2100-614. For operation with MV5000 lead/lag controller, see MV5000 installation manual 2100-636.

FIGURE 1
Programmable Thermostat Connections for Heat Pump with Economizer

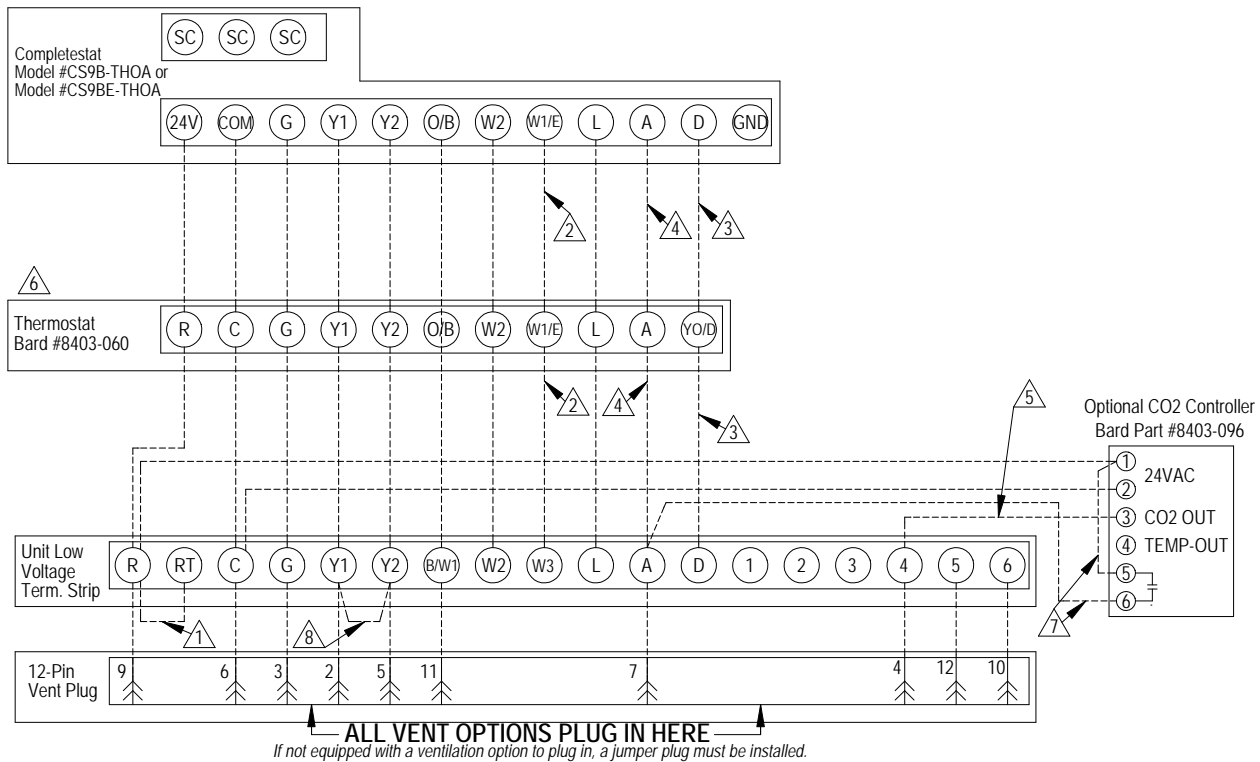

ALL VENT OPTIONS PLUG IN HERE
If not equipped with a ventilation option to plug in, a jumper plug must be installed.

- ① Factory installed jumper. Remove jumper and connect to N.C fire alarm circuit if emergency shutdown required.
- ② Wire not needed below 15KW.
- ③ Wire required for dehumidification models only.
- ④ Do not connect "A" from thermostat if optional CO2 controller is used
- ⑤ 0-10 VDC modulating CO2 control signal for modulating ventilation control (optional for ECON only - see vent instruction manuals)
- ⑥ Ensure model configuration is heat pump and not heat/cool. Must be configured to programmable and fan set to be programmed fan for the "A" output to function during scheduled occupied periods. Must be configured for multi-stage for Y1 output to be active 1st stage cooling. For dehumidification, must be configured for "No Economizer" for YO/D to be active for humidity control.
- ⑦ Do not add these wires if setting up for modulating control.
- ⑧ Factory installed jumper. Jumper is not installed on unit with economizers. Jumper is located in jade wiring harness.

MIS-4063 D

FIGURE 2
Non-Programmable Thermostat Connections for Heat Pump with Economizer

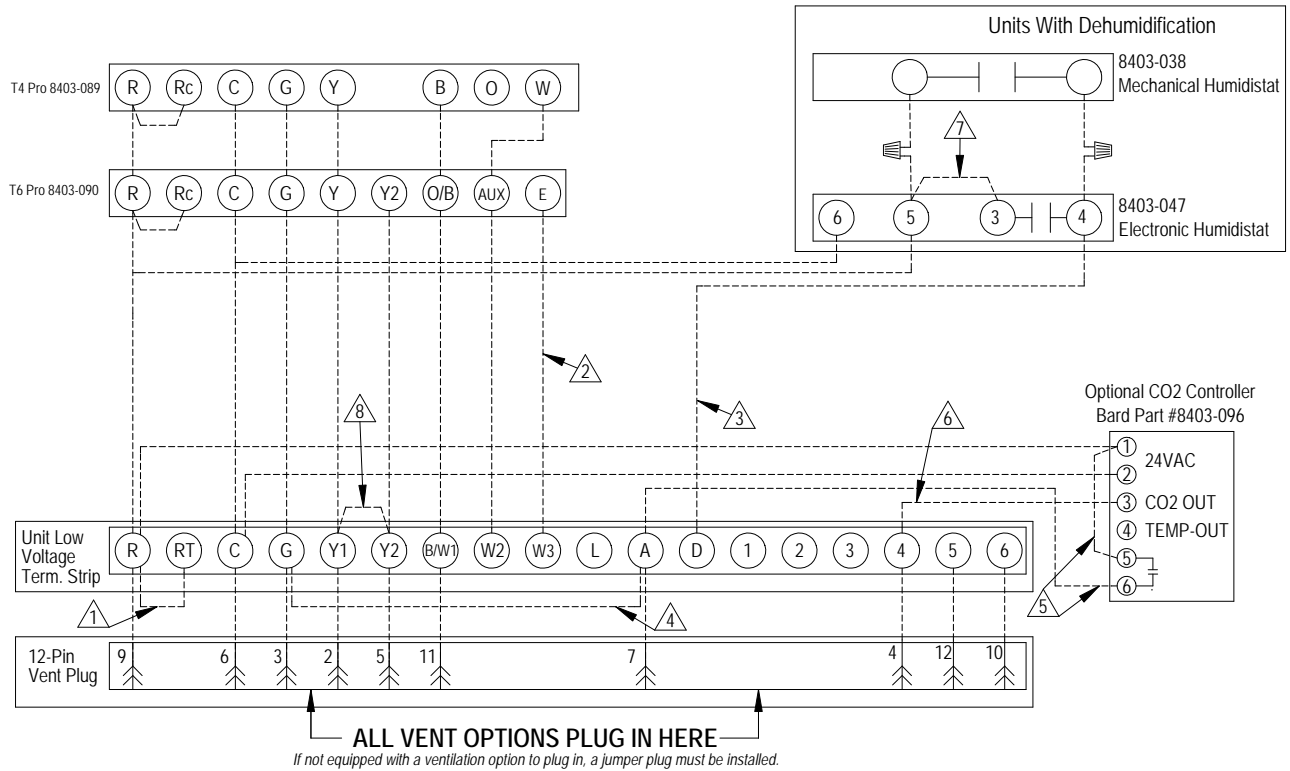

- | | |
|--|---|
| <p>1 Factory installed jumper. Remove jumper and connect to N.C fire alarm circuit if emergency shutdown required.</p> <p>2 Wire not needed below 15KW.</p> <p>3 Wire required for dehumidification models only.</p> <p>4 For vent operation, add jumper if optional CO2 controller is not used. Vent will run while blower is energized. For ECON & CRV-V, an additional wire change is required. See install manual.</p> <p>5 Do not add these wires if setting up for modulating control. See note 6.</p> | <p>6 0-10 VDC Modulating CO2 control signal for modulating ventilation control (Optional for ECON Only) - See vent installation manual.</p> <p>7 Jumper needs added.</p> <p>8 Factory installed jumper. Jumper is not installed on unit with economizers. Jumper is located in jade wiring harness.</p> |
|--|---|

MIS-4122 C

IMPORTANT NOTE

An additional wire change is required if jumper 4 is used which connects "A" to "G" (shown on Figure 10 on page 22). The red/white wire on the blower interlock relay (located on the vent control plate) needs to be moved from the "common" terminal to the "normally closed" terminal. **If this change is not made, the relay will latch on once the "A" signal is received and the blower will not turn off.** Refer to page 22 to see the vent wiring diagram with this change called out.

FIGURE 3
Programmable Thermostat Connections for Air Conditioner with Economizer

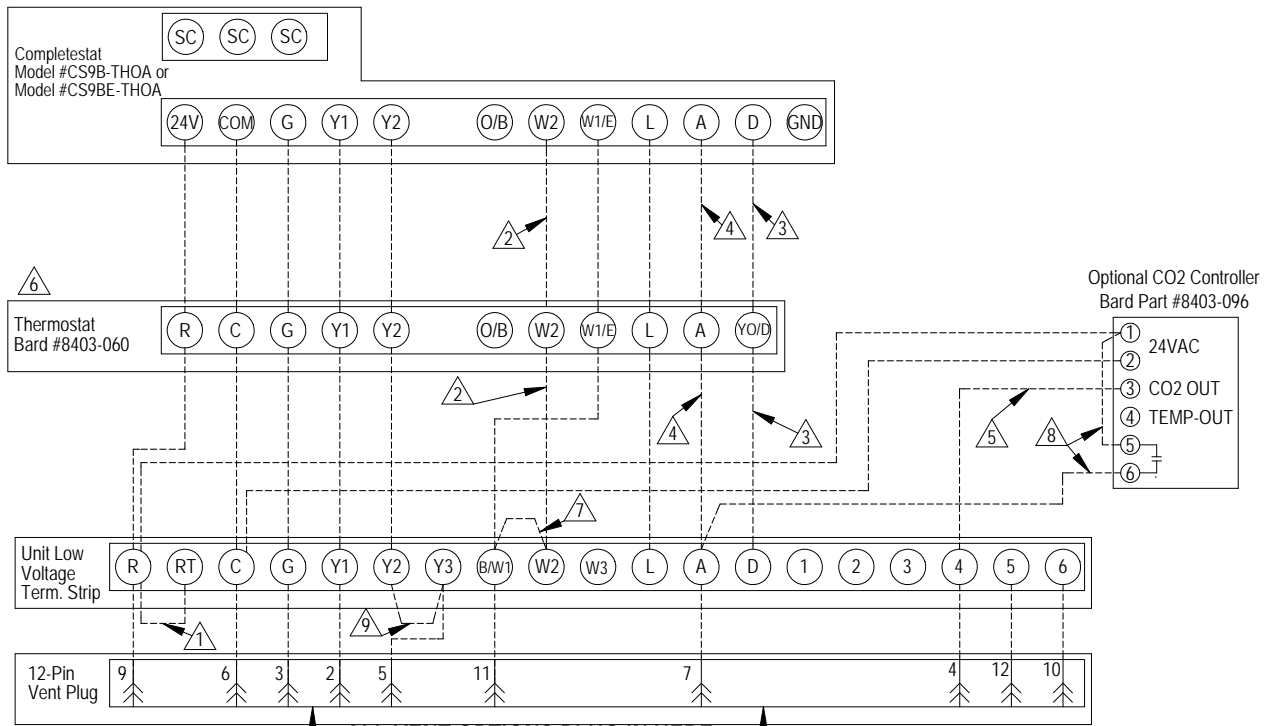

ALL VENT OPTIONS PLUG IN HERE
 If not equipped with a ventilation option to plug in, a jumper plug must be installed.

- | | |
|--|---|
| <ul style="list-style-type: none"> △1 Factory installed jumper. Remove jumper and connect to N.C fire alarm circuit if emergency shutdown required. △2 Wire not needed below 15KW. △3 Wire required for dehumidification models only. △4 Do not connect "A" from thermostat if optional CO2 controller is used △5 0-10 VDC modulating CO2 control signal for modulating ventilation control (optional for ECON only - see vent instruction manuals) | <ul style="list-style-type: none"> △6 Change model configuration from heat pump to heat/cool. Must be configured to programmable and fan set to be programmed fan for the "A" output to function during scheduled occupied periods. Must be configured for multi-stage for Y1 output to be active 1st stage cooling. For dehumidification, must be configured for "No Economizer" for YO/D to be active for humidity control. △7 Install jumper for 1 stage electric heat on units with less than 15KW △8 Do not add these wires if setting up for modulating control. See note 5. △9 Factory installed jumper. Must not be removed when Econ is installed. |
|--|---|

MIS-4291

FIGURE 4
Non-Programmable Thermostat Connections for Air Conditioner with Economizer

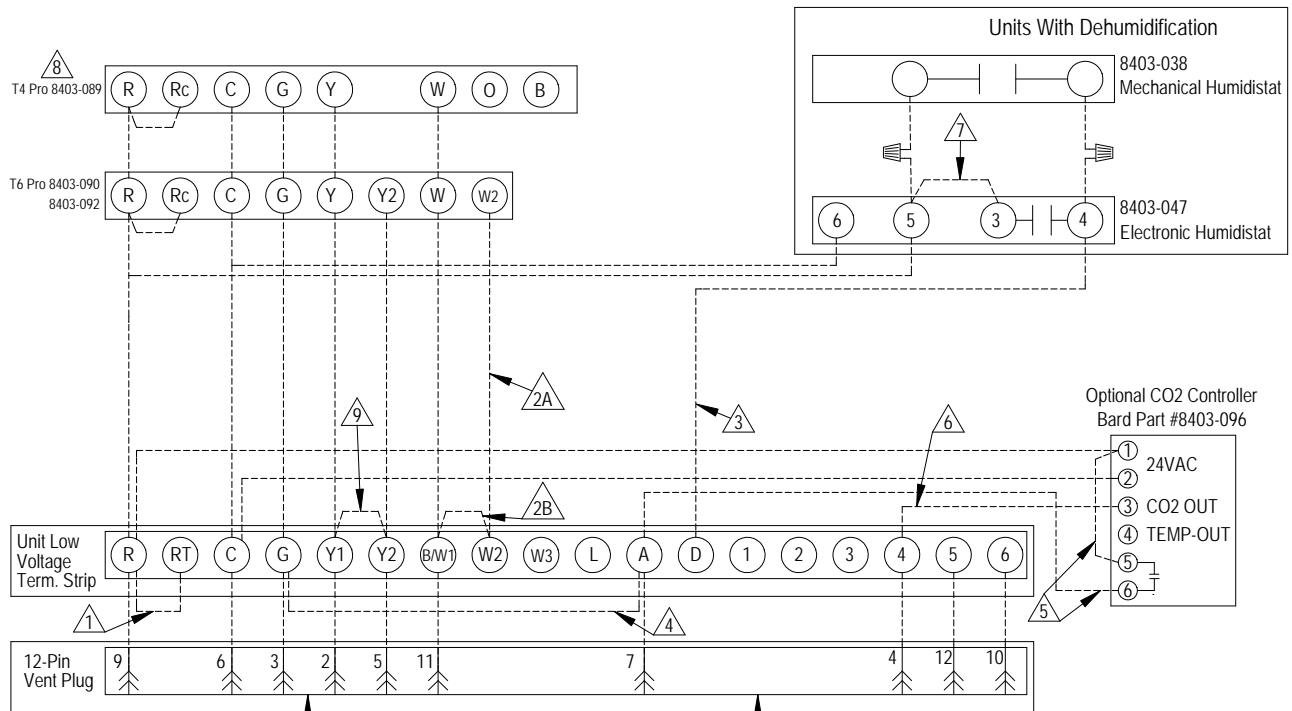

ALL VENT OPTIONS PLUG IN HERE

If not equipped with a ventilation option to plug in, a jumper plug must be installed.

- ⚠️ Factory installed jumper. Remove jumper and connect to N.C fire alarm circuit if emergency shutdown required.
- ⚠️ Wire not needed below 15KW.
- ⚠️ Install Jumper for 1 stage electric heat on units with more than 10KW.
- ⚠️ Wire required for dehumidification models only.
- ⚠️ For vent operation, add jumper if optional CO2 controller is not used.
- ⚠️ Vent will run while blower is energized.
- ⚠️ For ECON & CRV-V an additional wire change is required See install Manual.
- ⚠️ Do not add these wires if setting up for modulating control. See note 6.
- ⚠️ 0-10 VDC Modulating CO2 control signal for modulating ventilation control (Optional for ECON Only) - See vent installation manual.
- ⚠️ Jumper needs added.
- ⚠️ Thermostat will not work with units equipped with economizers.
- ⚠️ Factory installed jumper. Remove jumper to activate Balanced Climate™ Mode. A 2-stage thermostat is recommended for Balanced Climate mode. Y1 Y2 jumper not present if economizer is factory installed. Units with economizers have balanced climate jumper in economizer, refer to economizer manual.

MIS-3975 E

IMPORTANT NOTE

An additional wire change is required if jumper ⚠️ 4 is used which connects "A" to "G" (shown on Figure 10 on page 22). The red/white wire on the blower interlock relay (located on the vent control plate) needs to be moved from the "common" terminal to the "normally closed" terminal. **If this change is not made, the relay will latch on once the "A" signal is received and the blower will not turn off.** Refer to page 22 to see the vent wiring diagram with this change called out.

START-UP/CHECKOUT PROCEDURES

JADE™ Economizer Controller

W7220 controller offers unparalleled flexibility and expansion in a dependable and solid electronic platform.

- Multiple economizer applications from one controller.
- Nearly limitless customization of setpoints.
- Internal checkout menu provides fast performance assessment.
- Alarms menu provides assistance in troubleshooting.

Memory: User-defined setpoints remain in non-volatile flash memory regardless of electrical outage duration. Control voltage below 18V may cause erratic performance.

FIGURE 5
JADE™ Economizer Controller

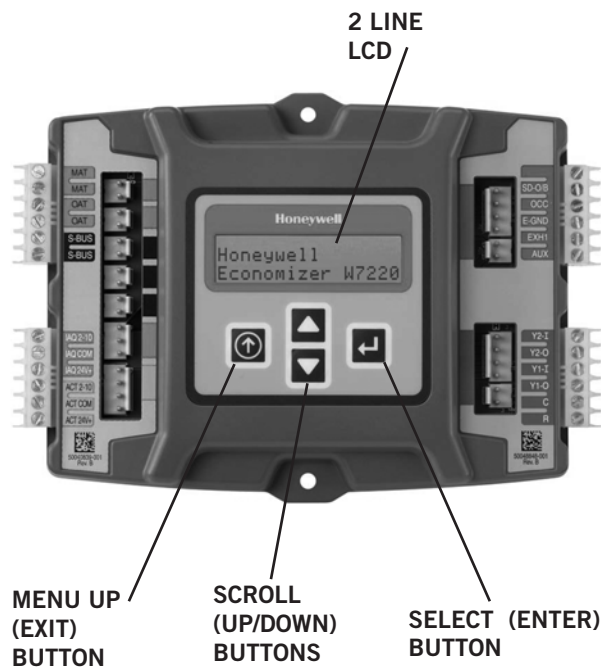

From the factory, the JADE economizer controller has been preset with “default” values that were pre-determined as optimum for equipment buildings, and these are shown in Tables 1 – 3. However, it is important to review and/or customize these operational values per owner specifications in order to guarantee satisfactory performance.

The installing contractor can easily access the JADE programming by the integral keypad and LCD display.

There are six (6) basic MENU categories to navigate:

1. **STATUS** – provides real-time access to sensor input, damper and equipment operation.
2. **SETPOINTS** – customizable operational parameters.
3. **SYSTEM SETUP** – customizable application programming (see Review/Customize System Setup).
4. **ADVANCED SETUP** – further application and operational options.
5. **CHECKOUT** – instantly activate and verify economizer functions.
6. **ALARMS** – displays alarms and pinpoints problem areas.

Review/Customize System Setup

Before being placed in service, the JADE economizer controller programming should be reviewed/customized through the following steps:

1. **SYSTEM SETUP:** from the main screen, press the **SCROLL (UP/DOWN) BUTTONS** to navigate through the six (6) basic menu items to the **SYSTEM SETUP** menu.
 - Push the **SELECT (ENTER) BUTTON** to choose the **SYSTEM SETUP** menu.
 - Navigate through the multiple levels of **SYSTEM SETUP** by pushing the **SCROLL (UP/DOWN) BUTTONS**.
 - To change a specific parameter in the **SYSTEM SETUP** menu, press the **SELECT (ENTER) BUTTON** to display its current value. Press the **SCROLL (UP/DOWN) BUTTONS** to change or increase/decrease value. Press the **SELECT (ENTER) BUTTON** to save the new customized value—“CHANGE STORED” will be displayed. Press the **SELECT (ENTER) BUTTON** again to return to current menu parameter.
 - For specific **SYSTEM SETUP** level information, refer to **Table 1**.

NOTE: During an extended level of inactivity, the display of the JADE economizer controller will begin to automatically scroll through the various levels of the STATUS menu as a screensaver. Each level will stay for approximately 5 seconds before changing to the next level.

TABLE 1
System Setup Menu Levels

Menu Level	Default Value	Range	Notes
INSTALL	01/01/10		Display Order = MM/DD/YY Setting Order = DD/MM/YY
UNITS DEG	°F	°F / °C	Sets controller to read in either measurements
EQUIPMENT	HP(B)	HP	Heat Pump HP * CONV = A/C
AUX IN	HP(B)	HP(O) HP(B)	Energize on Cool * Energize on Heat
FAN SPEED	1 Speed	1 Speed 2 Speed	
FAN CFM	5000	100 to 15000	Not applicable
AUX OUT	EXH2	NONE ERV EXH2 SYS	Product can be used to signal other devices
OCC	INPUT	INPUT or ALWAYS	INPUT is for dedicated OCC signal, ALWAYS is for all other situations
FACTORY DEFAULT	NO	YES or NO	Resets to factory defaults if changed to YES

* In **SYS SETUP**, the correct **Equipment** setting is **HP** and for the **AUX2 IN** is **HP (B)** in all applications. This is correct for both air conditioner and heat pump equipment in order to have correct operating sequences for the economizers. **DO NOT** change to **CONV = A/C** setting just because the equipment is an air conditioner and not a heat pump.

2. **ADVANCED SETUP:** from the main screen, press the **SCROLL (UP/DOWN) BUTTONS** to navigate through the six (6) basic menu items to the **ADVANCED SETUP** menu.

- Push the **SELECT (ENTER) BUTTON** to choose the **ADVANCED SETUP** menu.
- Navigate through the multiple levels of **ADVANCED SETUP** by pushing the **SCROLL (UP/DOWN) BUTTONS**.
- To change a specific parameter in the **ADVANCED SETUP** menu, press the **SELECT (ENTER) BUTTON** to display its current value. Press the **SCROLL (UP/DOWN) BUTTONS** to change or increase/decrease value. Press the **SELECT (ENTER) BUTTON** to save the new customized value—“**CHANGE STORED**” will be displayed. Press the **SELECT (ENTER) BUTTON** again to return to current menu parameter.
- For specific **ADVANCED SETUP** level information, refer to **Table 2**.

TABLE 2
Advanced Setup Menu Levels

Menu Level	Default Value	Range	Notes
MA LOW SET	45°F	35-55°	Temp to activate freeze protection — Close Damper
FREEZE POS	CLO	CLO or MIN	Damper position upon freeze protection
STG3 DLY	15 MIN	0 to 4.0h or OFF	Delay for 3rd Stage Cooling – allows for 3 stages of cooling, one stage for econ & two stages for compressor
DMPR POS	CLO	CLO or OPN	Where damper goes upon shutdown signal
MA T CAL	0.0°F	+/-2.5°F from actual reading	Mixed Air Sensor temperature calibration
OA T CAL	0.0°F	+/-2.5°F from actual reading	Outdoor Air Sensor temperature calibration
OAS H CAL	0%	+/-10% from actual reading	Outdoor Air Humidity Sensor calibration for economizers using temp/humidity sensor

3. **SETPOINTS:** from the main screen, press the **SCROLL (UP/DOWN) BUTTONS** to navigate through the six (6) basic menu items to the **SETPOINTS** menu.

- Push the **SELECT (ENTER) BUTTON** to choose the **SETPOINTS** menu.
- Navigate through the multiple levels of **SETPOINTS** by pushing the **SCROLL (UP/DOWN) BUTTONS**.
- To change a specific parameter in the **SETPOINTS** menu, press the **SELECT (ENTER) BUTTON** to display its current value. Press the **SCROLL (UP/DOWN) BUTTONS** to change or increase/decrease value. Press the **SELECT (ENTER) BUTTON** to save the new customized value—“**CHANGE STORED**” will be displayed. Press the **SELECT (ENTER) BUTTON** again to return to current menu parameter.
- For specific **SETPOINTS** level information, refer to **Table 3** on page 10.

NOTE: At this point, the economizer assembly should be fully functional and ready for preliminary testing.

**TABLE 3
Setpoints Menu Levels**

Menu Level	Default Value	Range	Notes
MAT SET	53°F	38°F to 65°F	Mixed Air Temperature setpoint at which the economizer damper will begin to modulate to maintain setting
LOW T LOCK	0°F	-45°F to 80°F	Low outdoor ambient temperature for compressor lockout
DRYBLB SET	60°F	48°F to 80°F	Maximum outdoor temperature setting for “free” economizer cooling
ENTH CURVE	ES3	ES1, ES2, ES3, ES4 or ES5	Enthalpy boundary “curves” for economizers using temp/humidity sensor, see “Enthalpy Settings” explanation
MIN POS	2V	2 to 10 VDC	Actuator voltage for Minimum Position – see Minimum Position Note
EXH1	50%	0 to 100%	Setpoint for damper if exhaust fan is powered by economizer
EXH2	6%	0 to 100%	Setpoint for AUX output signal
DCV SET (See NOTE under Table 6 on page 11)	1100	500 to 2000	Displays only if a CO ₂ sensor is connected. Setpoint for Demand Control Ventilation of space. Above the setpoint, the OA dampers will modulate open to bring in additional OA to maintain a space ppm level below the setpoint.

MINIMUM POSITION NOTE: *Minimum position setting has been preset to 10V which when connected to MC4002 Lead/Lag Controller System will allow economizer to drive wide open per emergency ventilation strategy as detailed in MC4002 Instructions. This may require resetting to a lower value per job specifications.*

4. **CHECKOUT:** from the main screen, press the **SCROLL (UP/DOWN) BUTTONS** to navigate through the six (6) basic menu items to the **CHECKOUT** menu.

- Push the **SELECT (ENTER) BUTTON** to choose the **CHECKOUT** menu.
- Navigate through the multiple levels of **CHECKOUT** by pushing the **SCROLL (UP/DOWN) BUTTONS**.
- To perform a specific test in the **CHECKOUT** menu, press the **SELECT (ENTER) BUTTON** to choose a particular exercise, “**RUN?**” will appear. Press the **SELECT (ENTER) BUTTON** again to activate this exercise. After a short pause, “**IN PROGRESS**” will appear as the test activates. “**DONE**” will display after the test is complete. Press the **MENU UP (EXIT) BUTTON** to end the test and/or turn off the activated relay.
- For specific **CHECKOUT** level information, refer to **Table 4**.

NOTE: CHECKOUT functions bypass the normal 5-minute delay for compressor protection. Be sure to allow for enough time to pass between tests so the compressor is not damaged from extreme short-cycling.

**TABLE 4
Checkout Menu Levels**

Menu Level	Notes
DAMPER VMIN-HS	Positions damper to the minimum amount of opening allowed by actuator
DAMPER VMAX-HS	Opens damper to the MIN POS level indicated in the SETPOINTS menu. See Minimum Position Note above.
DAMPER OPEN	Forces damper to full open position, energizes exhaust contacts
DAMPER CLOSE	Positions damper to completely closed position
CONNECT Y1-0	Forces Y1-OUTPUT to compressor
CONNECT Y2-0	Forces Y2-OUTPUT to compressor
CONNECT EXH1	Setpoint for damper if exhaust fan is powered by economizer
CONNECT EXH2	Setpoint for AUX output signal
CONNECT AUX	Depending upon AUX OUT setting from SYSTEM SETUP menu: NONE – no action ERV – 24VAC out for ERV & NOT Economizer SYS – 24VAC out for alarm

NOTE: Economizer assembly should be ready to put into service. At any point during operation, in economizer mode or idle, real-time information from sensors and integral components can be accessed from the **STATUS** menu.

5. **STATUS:** from the main screen, press the **SCROLL (UP/DOWN) BUTTONS** to navigate through the six (6) basic menu items to the **STATUS** menu.

- Push the **SELECT (ENTER) BUTTON** to choose the **STATUS** menu.
- Navigate through the multiple levels of **STATUS** by pushing the **SCROLL (UP/DOWN) BUTTONS**.
- As the **STATUS** menu simply gives input/output information in real-time, there is no way to change or otherwise alter the displayed criteria. It is simply a window into the operation of the economizer controller.
- For specific **STATUS** level information, refer to **Table 5**.

NOTE: Upon power-up (or after power failure or low voltage condition), the controller will begin a 5-minute time delay before enabling mechanical cooling.

TABLE 5
Status Menu Levels

Menu Level	Default Value	Notes
ECON AVAIL	YES/NO	Indicates if conditions are favorable for economizing
ECONOMIZING	YES/NO	Indicates if economizer is actively economizing
OCCUPIED	YES/NO	Indicates if dedicated 24V occupied signal is being received on terminal OCC
HEAT PUMP	COOL/HEAT	Displays actual compressor use if in HEAT PUMP mode
COOL Y1-IN	ON/OFF	Indicates if 24V signal is being received on terminal Y1-I
COOL Y1-OUT	ON/OFF	Displays if controller is actively calling for mechanical compressor cooling (24V on Y1-O)
COOL Y2-IN	ON/OFF	Indicates if 24V signal is being received on terminal Y2-I
COOL Y2-OUT	ON/OFF	Displays if controller is actively calling for Stg. 2 cooling (24V on Y2-O)
MA TEMP	0° to 140°F	Current mixed air temp
OA TEMP	-40° to 140°F	Current outdoor air temp
OA HUM	0% to 100%	Current outdoor air humidity for economizers using temp/humidity sensor
DAMPER OUT	2.0 to 10.0	Displays voltage to actuator
ACT POS	0 to 100%	Current % of opening
ACT COUNT	N/A	Current count of actuator cycles from installation
ACTUATOR OK	YES/NO	Indicates potential fault
EXH1 OUT	ON/OFF	Output of EXH1 Terminal
MECH COOL ON	0, 1, or 2	Stages of mechanical cooling currently active

NOTE: If there are any potential problems recognized by the economizer controller, it may be registered in the form of an alarm in the **ALARM(S)** menu. If there is a period of inactivity AND there is an alarm registering, the controller will randomly scroll through the **ALARM(S)** menu items as a screensaver.

ALARM(S): from the main screen, press the **SCROLL (UP/DOWN) BUTTONS** to navigate through the six (6) basic menu items to the **ALARM(S)** menu.

- Push the **SELECT (ENTER) BUTTON** to choose the **ALARM(S)** menu.
- Navigate through the current alarms in **ALARM(S)** by pushing the **SCROLL (UP/DOWN) BUTTONS**.
- Once the alarm has been identified, and the cause has been removed (e.g., replaced faulty sensor), the alarm may erase itself. If a manual alarm-erasing is required, it can be cleared from the display by navigating to the desired alarm and pressing the **SELECT (ENTER) BUTTON** to choose that specific alarm. **“ERASE?”** will display. Press the **SELECT (ENTER) BUTTON** again. **“ALARM ERASED”** will appear. Press the **MENU UP (EXIT) BUTTON** to complete the action and return to the previous menu.
- For specific **ALARM(S)** information, refer to **Table 6**.

TABLE 6
Alarm Examples

Alarm(s)	Notes
MA T SENS ERR	Malfunctioning mixed air sensor
OA T SENS ERR	Malfunctioning outdoor air sensor
ACT STALLED	Actuator cannot reach desired percentage of opening
SYS ALARM	If AUX is set to SYS in SETPOINTS menu, SYS will display upon any registered alarm
NOTE: This is not a complete list of alarms. Additional alarms will display depending upon the parameter settings and configuration and attached equipment.	

NOTE: When using the Bard 8403-096 CO₂ controller, configure the sensor to 2-10VDC output (see CO₂ sensor instructions). See also Figure 9 on page 18.

The JADE controller default setting is 1100 PPM. The economizer will modulate to maintain this CO₂ level in the room. The default setting can be changed in the SETPOINT menu in the DCV SET option. Default settings and DCV MIN and DCV MAX will appear only when the CO₂ sensor is connected.

In the SETPOINT menu, change the MAX VENT setting to 9.5 volts.

The CO₂ controller is active at any time the A terminal is energized.

The status of the CO₂ input can be viewed at any time in the STATUS menu.

Enthalpy Settings

If economizer is enthalpy-based and was shipped with the temp/humidity sensor, the economizer must be programmed for the specific enthalpy curve boundary desired for “free” outdoor cooling. The available enthalpy boundaries are all subject to specific OA temperature, OA humidity and OA dew points. If all of the OA conditions are below the specific points outlined in each boundary, the conditions are good to economize and economizer mode is set to “YES”. If some or all the OA conditions are above the specific points outlined in each boundary, the conditions are not good to economize and the economizer mode is set to “NO”.

ES3 is factory default.

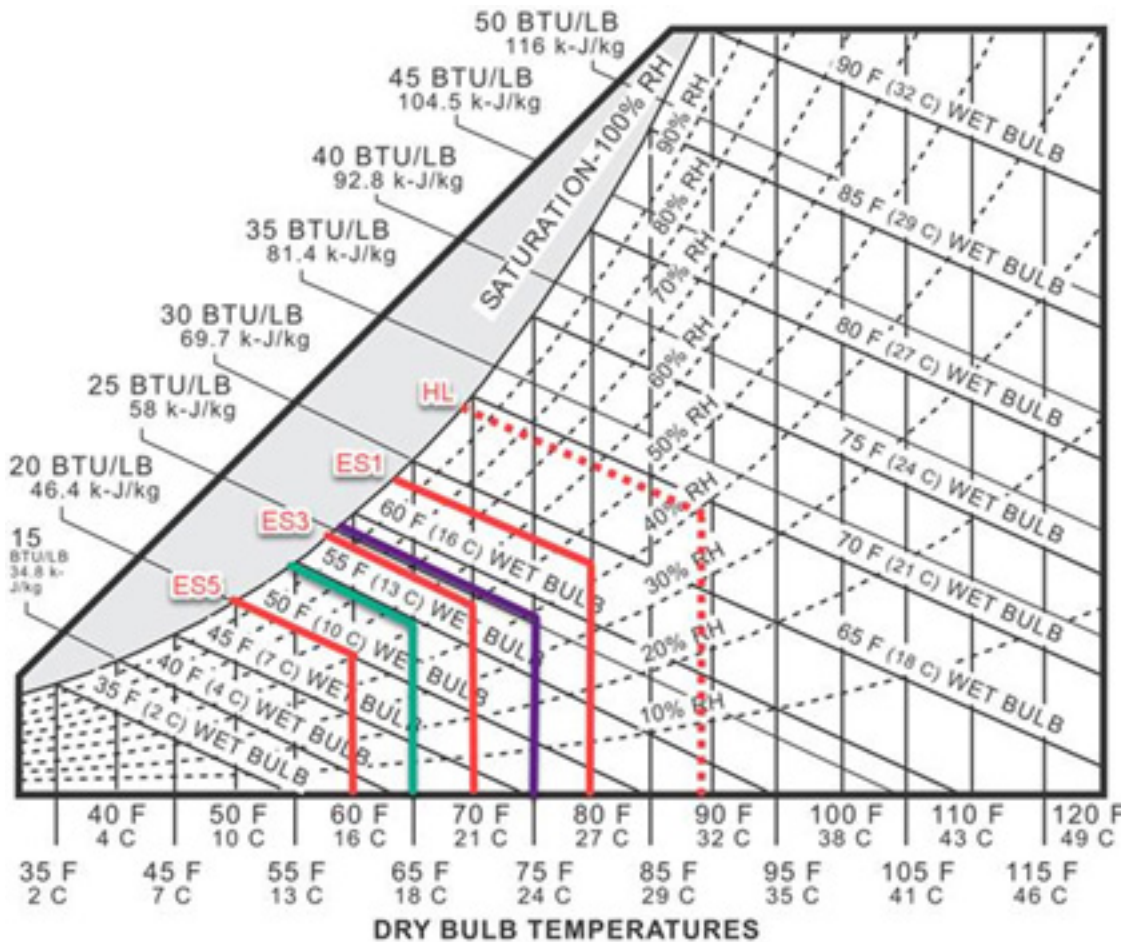

Economizer Sequence of Operation

Condition – Cool/Dry OA Conditions

- 1st Stage Cooling closes and sends signal to JADE control. Since the air temperature outside is cooler than the preset **DRYBULB SET** setting, or is below the **ENTH CURVE** boundary in the **SETPOINTS** menu, the actuator will power the economizer damper to “economizer” mode as the indoor blower motor starts. The mixed air sensor senses a mixture of return air and cool outdoor air and modulates opening to achieve preset **MAT SET** setting in **SETPOINTS** menu. Compressor operation is inhibited (see Figure 6).
- 2nd Stage Cooling closes and sends a signal to JADE control, which closes the Y1-O relay to begin mechanical cooling. **The economizer damper REMAINS OPEN in tandem operation with the compressor** as long as the OA conditions do not drop below the preset **DRYBULB SET/ENTH CURVE** settings in the **SETPOINTS** menu (see Figure 7).
- 3rd Stage Cooling (if available) closes and sends a signal to JADE control, which closes the Y2-O relay to begin 2nd stage mechanical cooling. **The economizer damper REMAINS OPEN in tandem operation with the compressor** as long as the temperature outside does not drop below the preset **DRYBULB SET** setting in the **SETPOINTS** menu (see Figure 7).

Condition – Warm/Humid OA Conditions

- 1st Stage Cooling closes and sends signal to JADE control. Since the OA conditions are above the preset **DRYBULB SET/ENTH CURVE** setting in the **SETPOINTS** menu, the control will simply close the Y1-O relay to initiate mechanical cooling. **The economizer damper will remain closed or in a minimum ventilation setting depending upon occupied status** (see Figure 8 on page 14).
- 2nd Stage Cooling (if available) closes and sends a signal to JADE control. Since the OA conditions are still above than the preset **DRYBULB SET/ENTH CURVE** setting in the **SETPOINTS** menu, the control will simply close the Y2-O relay to initiate 2nd stage mechanical cooling. **The economizer damper will remain closed or in a minimum ventilation setting depending upon occupied status** (see Figure 8).

FIGURE 6
Outside Airflow Path

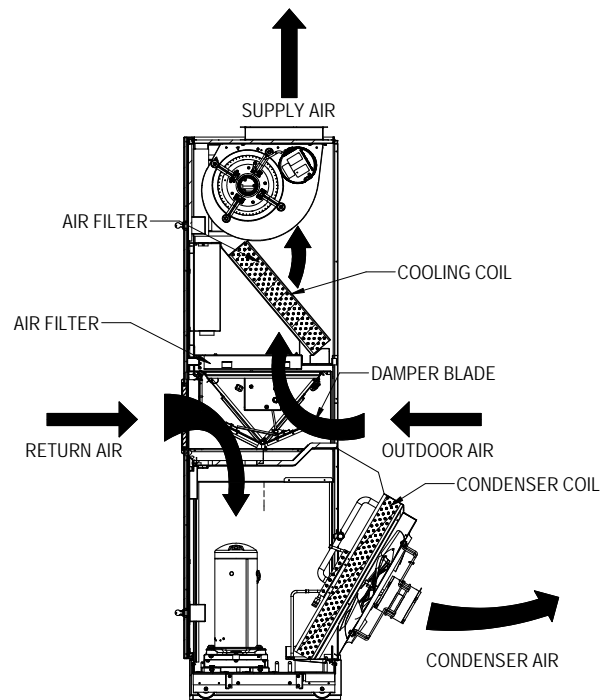

MIS-4227

FIGURE 7
Mixed Airflow Path

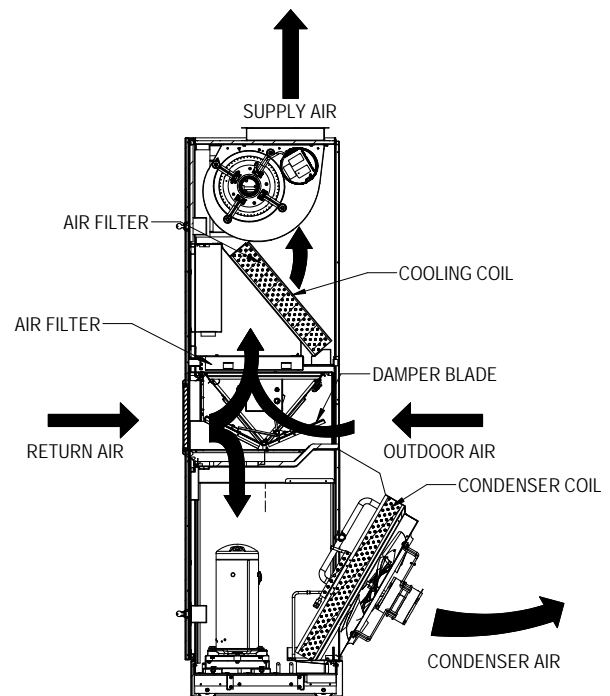

MIS-4217

FIGURE 8
100% Closed Loop Airflow Path

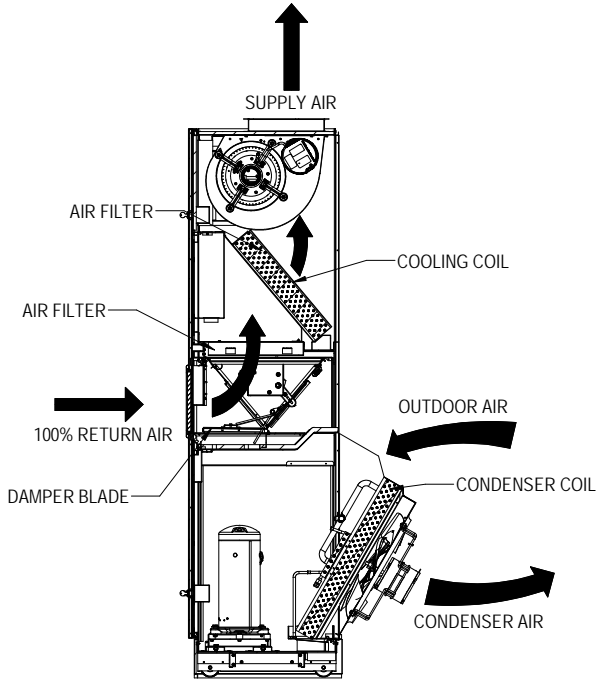

MIS-4218

Economizer Operation for Single Stage:

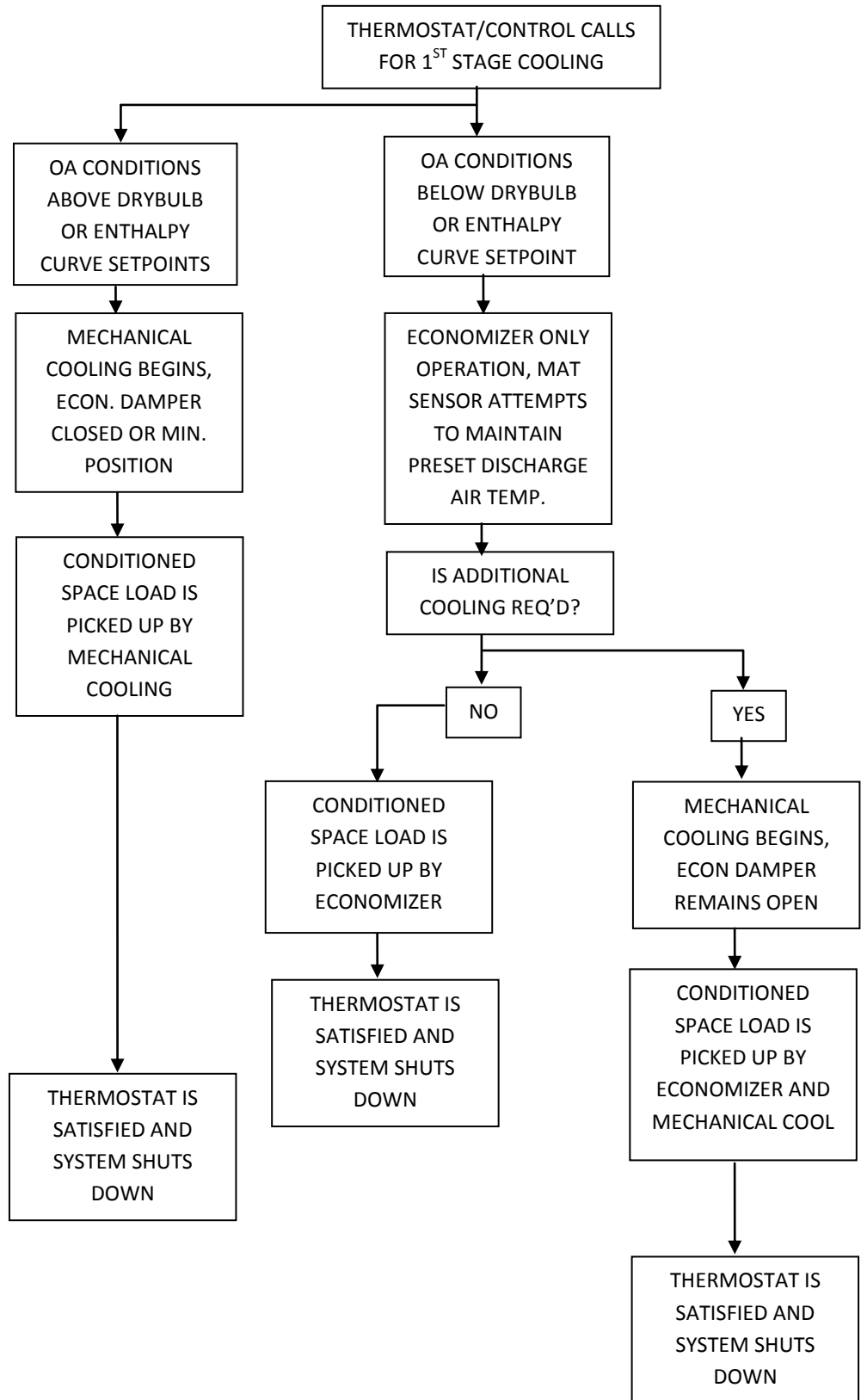

Balanced Climate Mode – S Economizer Sequence of Operation

Balanced Climate can be used for duct free and ducted applications below 0.2" W.C. ESP total static.

Call for cooling and ECONOMIZER IS NOT AVAILABLE (due to outdoor conditions):

Y1 energizes mechanical cooling and the Balanced Climate fan speed simultaneously. If the outdoor conditions are not acceptable, the Y2 terminal will energize the fan speed to the rated airflow. When the temperature drops below the Y2 setpoint, the unit will return to the Balanced Climate fan speed. When the cooling call is satisfied, the compressor will shut down and the economizer will move to minimum position (ventilation setting) and the fan will continue to run at RATED airflow if A is energized on the low voltage terminal strip.

Call for cooling and ECONOMIZER IS AVAILABLE (due to outdoor conditions):

Two stage cooling thermostat is required and connector is disconnected at JADE controller to enable Balanced Climate mode (see wiring diagram 4056-256 on page 22).

Unit has a call for ventilation: Damper to Min position and fan will run at RATED airflow. (When using Balanced Climate mode, increase the minimum position blade setting to allow 28% more outdoor air CFM than rated.) Y1 energizes economizer and the Balance Climate fan speed simultaneously. If the temperature continues to rise, the Y2 terminal will increase the fan speed to the RATED airflow. When the temperature drops below the Y2 setpoint, the unit will return to the Balanced Climate fan speed. When the cooling call is satisfied, the compressor will shut down and the economizer will move to minimum position (ventilation setting) and the fan will increase to run at RATED airflow if A is energized on the low voltage terminal strip.

**TABLE 7
Unit Operation with S (Part Flow) Economizer**

Unit Operation	Occupancy Signal	Low Voltage 24VAC							Fan Speed	Compressor Operation	Damper	
		G	Y1	Y2	W1	W2	A	D				
Fan Only	Yes	X						X	Vent	Off	Min Pos	
Fan Only	No	X							Vent	Off	Closed	
BC Cooling	Yes	X	X					X	B Climate	Econ	Min Pos	
BC Cooling	No	X	X						B Climate	Econ	Closed	
Full Load Cool	Yes	X	X	X				X	Lo/Med/Hi	On	Min Pos	
Full Load Cool	No	X	X	X					Lo/Med/Hi	On	Closed	
1st Stage Heat	Yes	X	X		X			X	Lo/Med/Hi	On	Min Pos	
1st Stage Heat	No	X	X		X				Lo/Med/Hi	On	Closed	
2nd Stage Heat	Yes	X	X	X	X	X		X	Lo/Med/Hi	Off	Min Pos	
2nd Stage Heat	No	X	X	X	X	X			Lo/Med/Hi	Off	Closed	
Dehumidify ²	Yes							X	X	B Climate	On	Min Pos
Dehumidify ²	No								X	B Climate	On	Closed

BC and B Climate – Balanced Climate

- ¹ Fan speed is selectable through the blower speed control terminal block. LO (default), MED or HI speeds can be used.
- ² Dehumidification operation is disabled when a call for heating or cooling occurs. Unit runs at Balanced Climate speed during dehumidification operation.

Economizer Operation – Balanced Climate Mode

Connector disconnected from JADE™ controller (see wiring diagram on page 22)

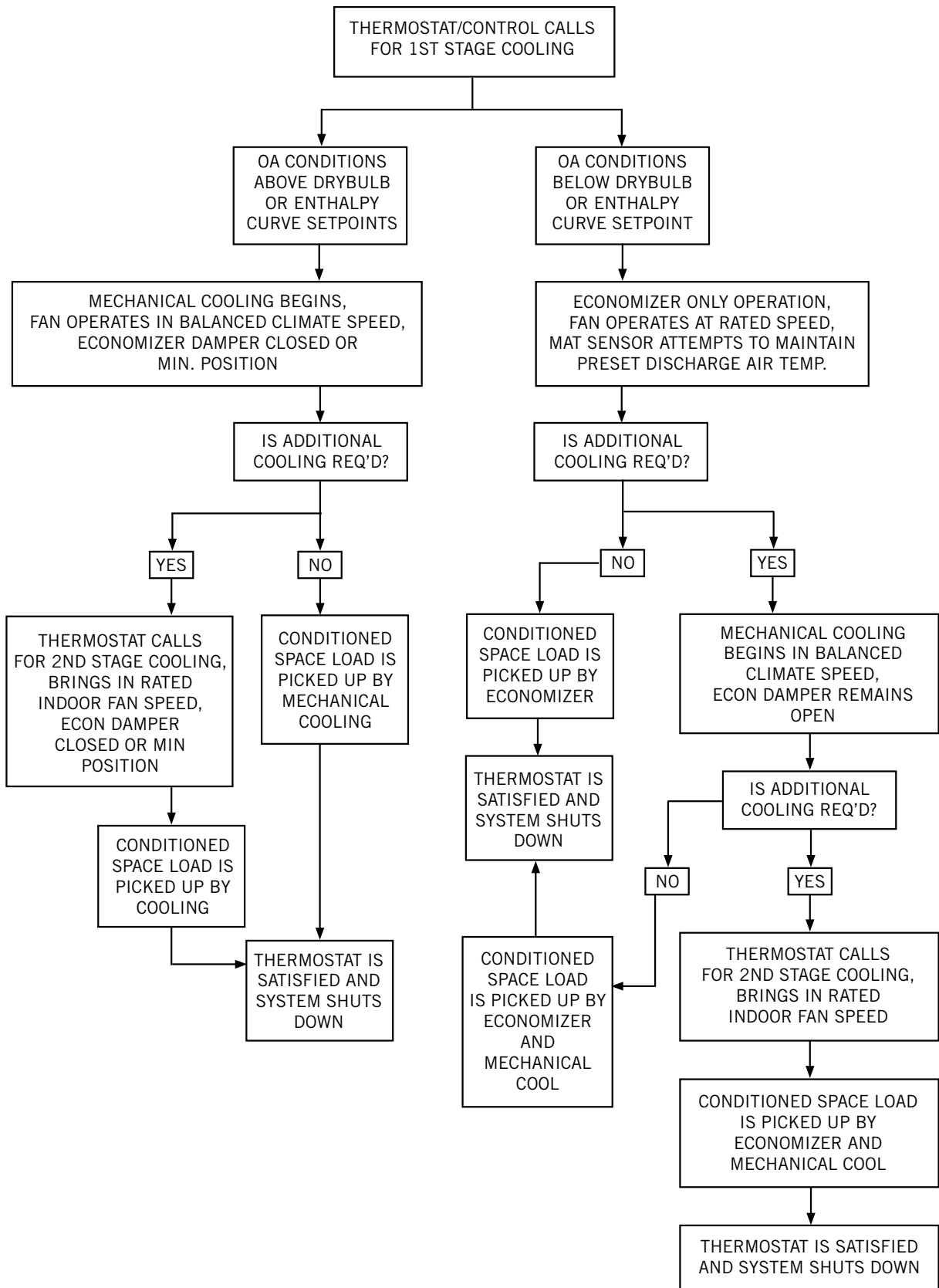
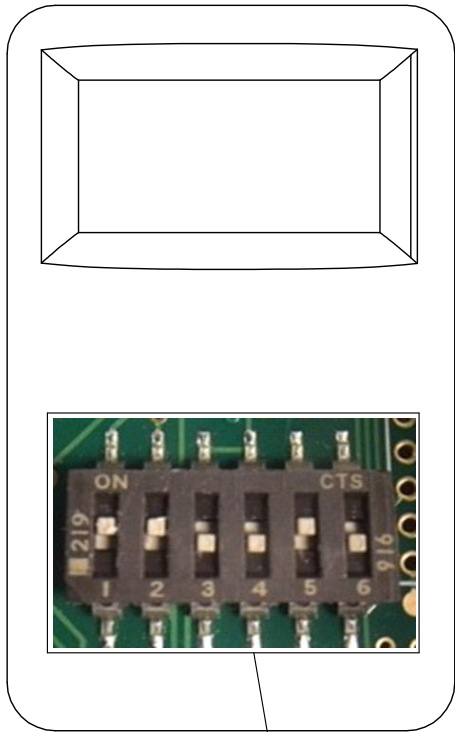
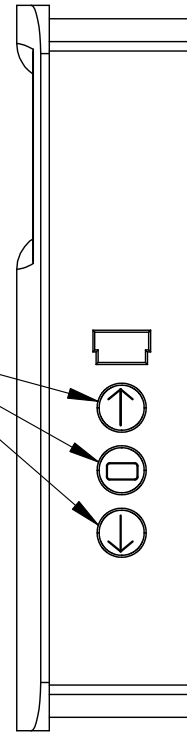

FIGURE 9
CO₂ Sensor Default and Final Settings
Bard Part #8403-096 CO₂ Controller



PRESS UP AND DOWN ARROWS TO ENTER CONFIGURATION MODE. USE ARROWS TO SELECT SETTING. PUSH MIDDLE BUTTON TO CHANGE. CONTROLLER WILL SHOW SET.



NOTE: MENU DIP SWITCH MUST BE IN "ON" POSITION #5 TO CHANGE ANY SETTINGS WITH THE SIDE BUTTONS. TO LOCK THE CO₂ CONTROLLER MOVE DIP SWITCH TO "OFF" AFTER IT HAS BEEN CONFIGURED.

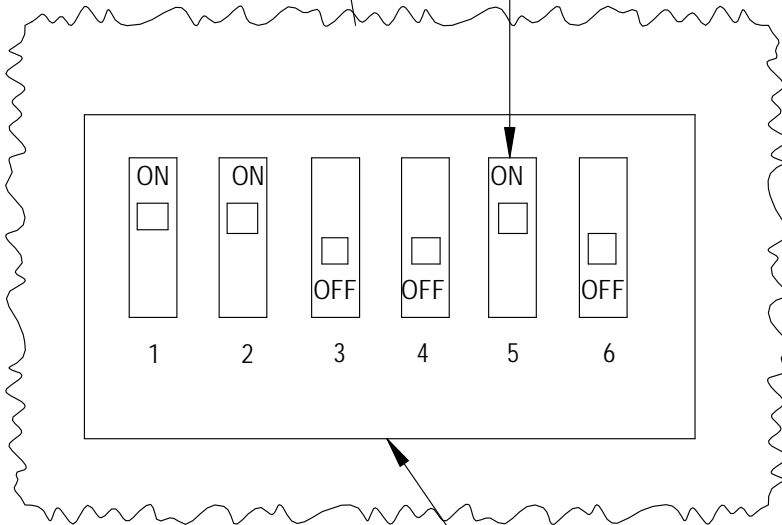

DIP SWITCHES MUST BE POSITIONED AS SHOWN FOR PROPER OPERATION

Settings	Recommended	Default
RON	Not Used	
ROF	Not Used	
DSP	C	CT
UNI	US	US
COL	700	0
COH	1500	2000
TOL	Not Used	
TOH	Not Used	
BAR	See Instruction with Controller For High Altitude Installations	
CAL	Used for Field Calibration	

MIS-4025 A

GRAPH 1
Q24H4 Economizer Ventilation Delivery

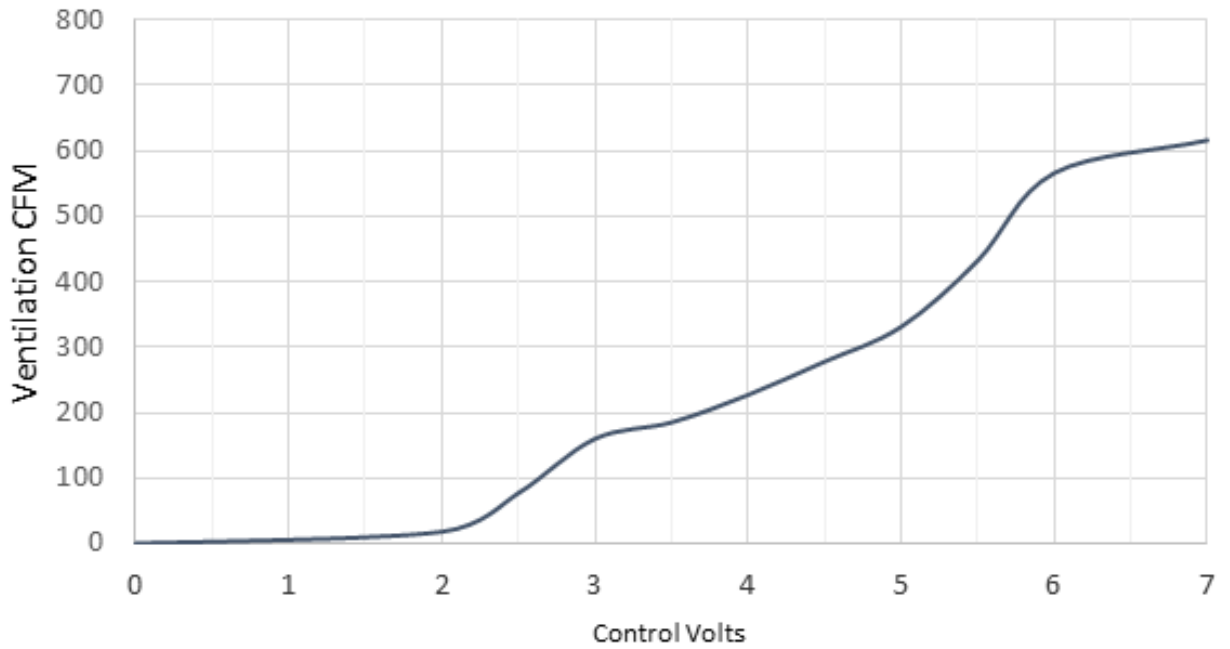

Constant CFM .10 Through .5 Static

GRAPH 2
Q30H4 Economizer Ventilation Delivery

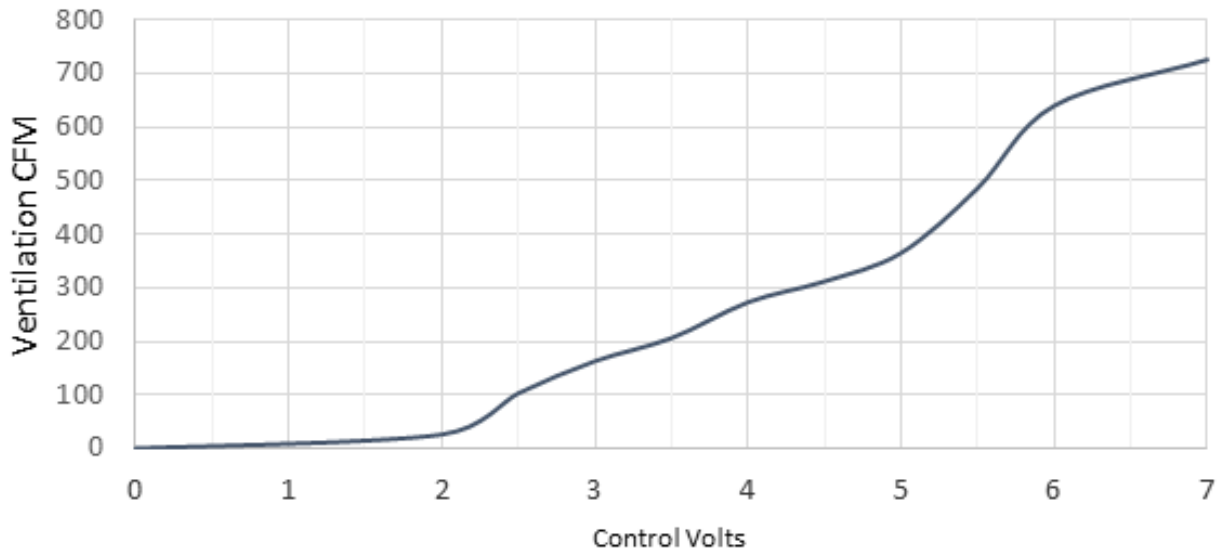

Constant CFM .10 Through .5 Static

GRAPH 3
Q36A4 and Q36H4 Economizer Ventilation Delivery

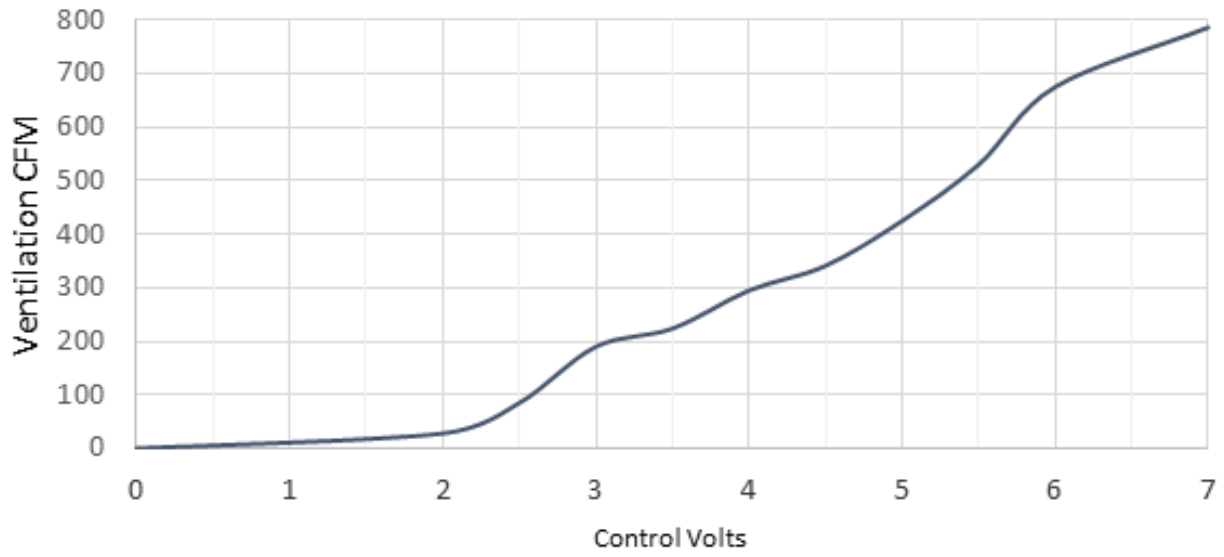

Constant CFM .10 Through .5 Static

GRAPH 4
Q42A4 and Q43H4 Economizer Ventilation Delivery

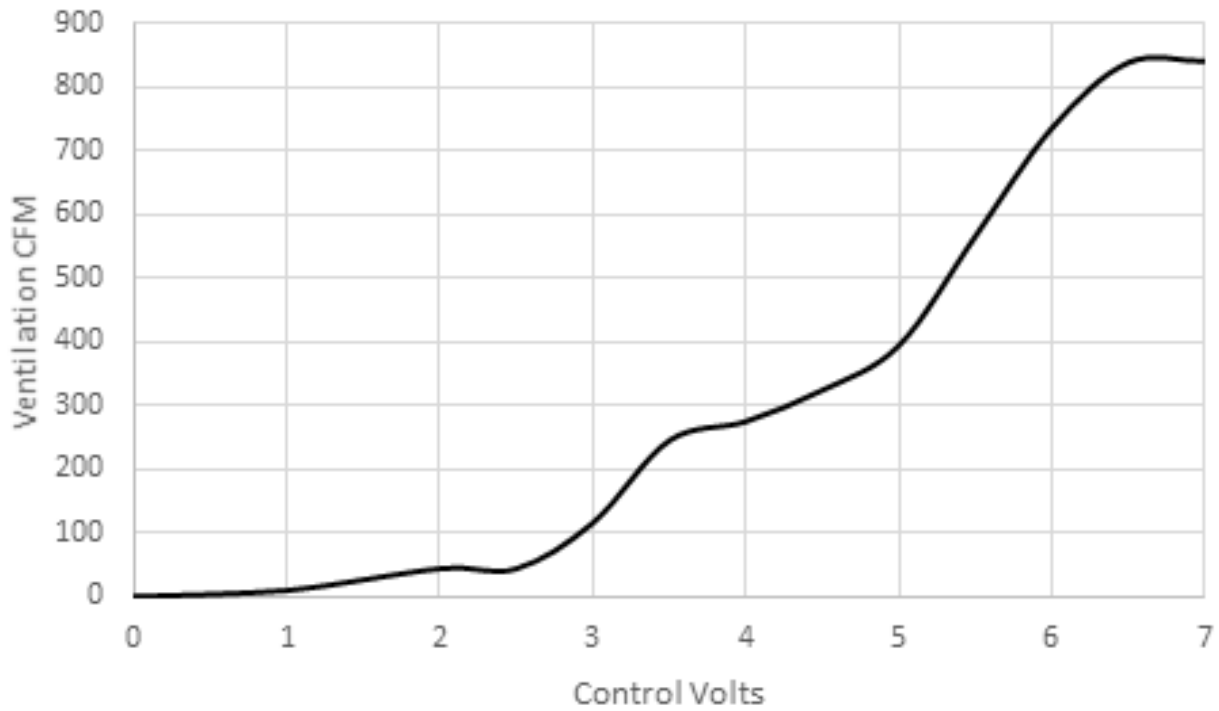

Constant CFM .10 Through .5 Static

GRAPH 5
Q48A4 and Q48H4 Economizer Ventilation Delivery

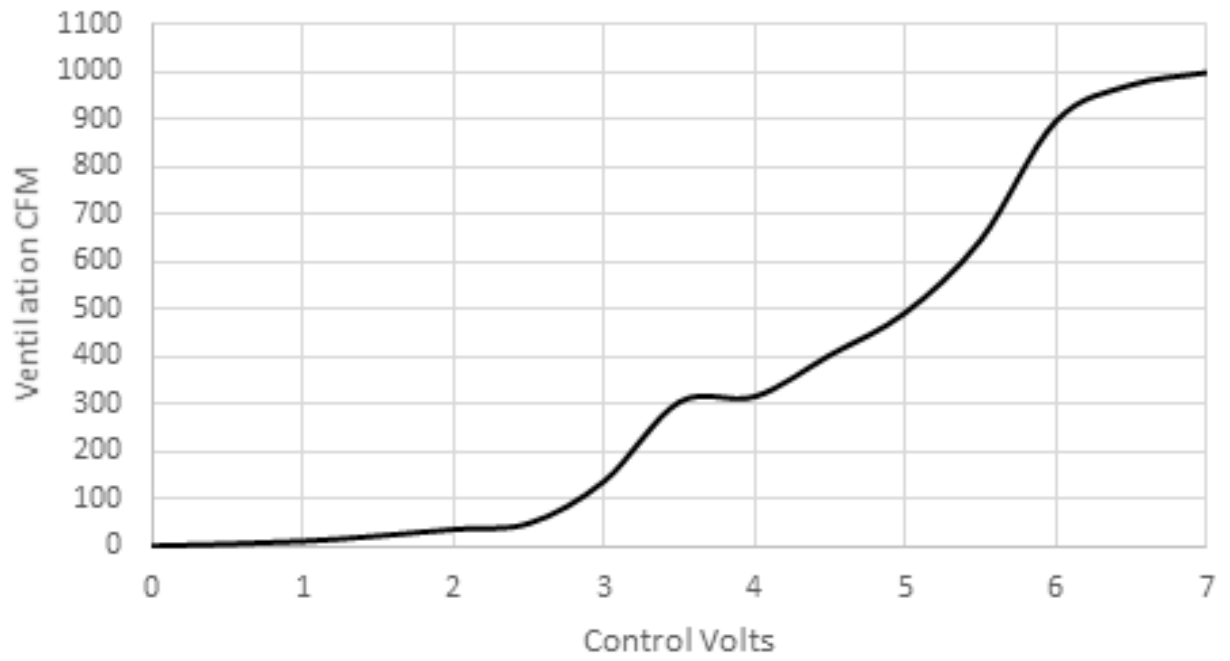

Constant CFM .10 Through .5 Static

FIGURE 10
Wiring Diagram – Enthalpy Sensor

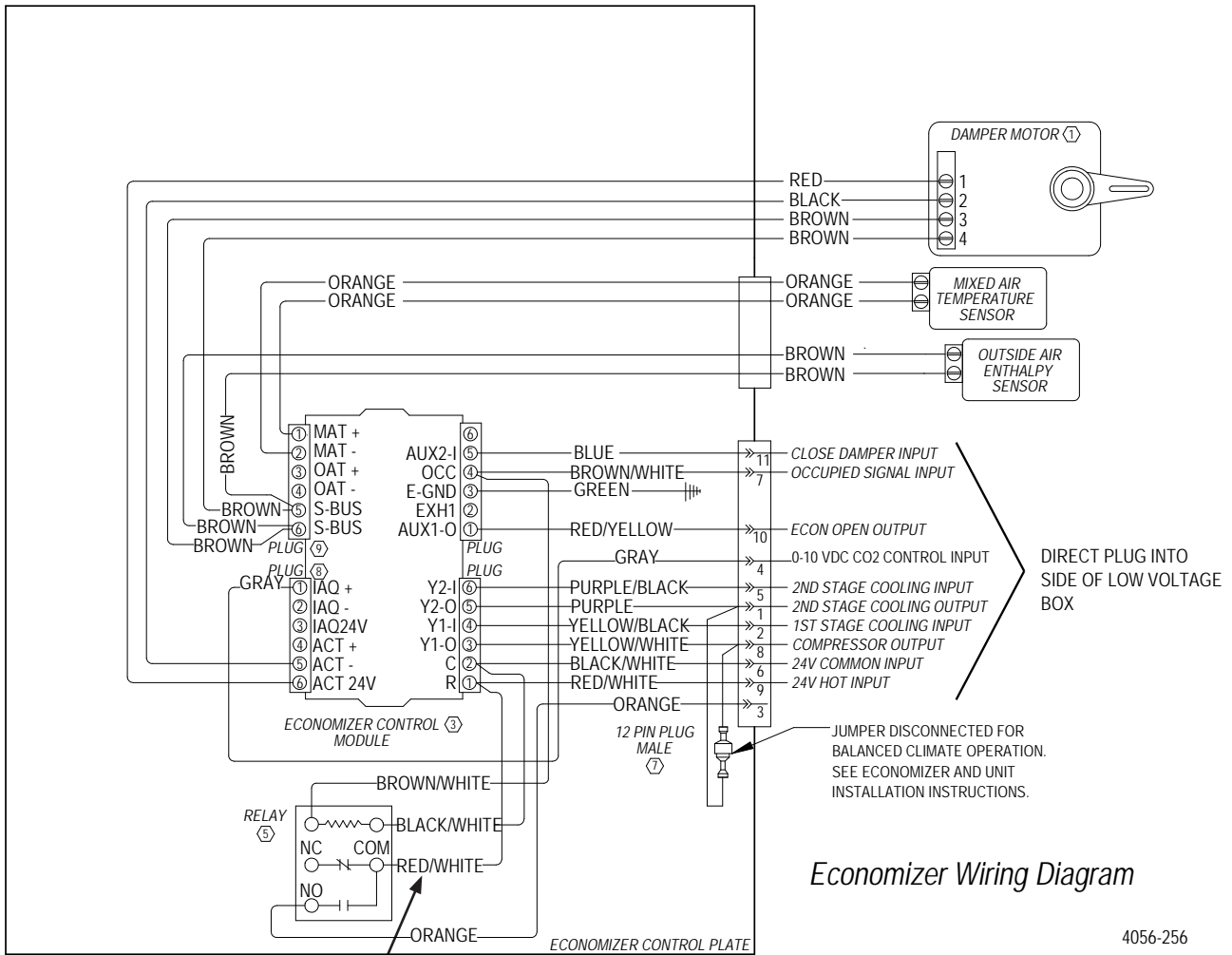

Economizer Wiring Diagram

4056-256

Move this RED/WHITE wire from COM to NC if jumper is used between A and G. See page 5 or 7 for additional information.