SERVICE INSTRUCTIONS

FUSION-TEC® Wall-Mount Air Conditioner



Models:

WR35BPA WR36BPA WR58BPA
WR35BPB WR36BPB WR58BPB

***NOTE: LC6000 controller is required for operation when
WR**BP* units are used.***



Climate Control Solutions

Bard Manufacturing Company, Inc.
Bryan, Ohio 43506
www.bardhvac.com

Manual: 2100-695D
Supersedes: 2100-695C
Date: 9-17-21

CONTENTS

Using the TEC-EYE™	6	Indoor Airflow.....	20
TEC-EYE Hand-Held Diagnostic Tool.....	6	Indoor Airflow Components.....	20
TEC-EYE Screen Structure and Password Level.....	7	Blower.....	20
TEC-EYE Acronyms.....	7	Blower Status Switch.....	22
Main Status Screen.....	7	Blower Status Alarm.....	22
Quick Menu.....	8	Filters.....	22
Setpoints.....	8	Dirty Filter Switch.....	22
Information.....	8	Dirty Filter Alarm.....	23
Staging Information.....	8	Filter Indicator Light.....	23
Orphan Mode Staging.....	8	Indoor Airflow Operation.....	23
Master Staging.....	8	High Sensible Mode.....	23
A/C Circuit Measurements.....	9	Blower Speed Control.....	24
Last 24 Hour Operation.....	9	Additional Indoor Airflow Alarms.....	24
Component Lifetime Hours.....	9	Supply Air Temperature Alarm.....	24
Software Version.....	9	Condenser Fan.....	24
Software Versioning Guide.....	9	Condenser Fan Components.....	24
Alarm Log.....	10	Condenser Fan.....	24
Addressing Wall-Mount Units.....	10	Liquid Line Pressure Transducer.....	25
Executing a Self Test.....	10	Troubleshooting the Liquid Pressure	
Self Test Parameter Descriptions.....	10	Transducer.....	25
Reset to Factory Defaults.....	10	Liquid Pressure Transducer Alarm.....	26
Operation	12	Liquid Temperature Sensor.....	26
Unit On/Off.....	12	Condenser Fan Operation.....	26
Alarm Adjustment.....	12	Condenser Fan Speed Control.....	26
Acknowledging Alarms.....	12	High Pressure Control.....	26
Clearing Alarms.....	12	Condenser Fan Speed.....	26
Clearing Alarm Logs and Counters.....	12	Second Stage Drop Out.....	26
Exporting Alarm Logs.....	12	Low Ambient Control.....	26
Exporting 7 Day Logs.....	12	Compressor.....	27
Orphan Mode.....	13	Compressor Components.....	27
Zone.....	13	Compressor.....	27
Temperature/Humidity Control.....	13	Compressor Control Module (CCM).....	27
Temperature/Humidity Control Components.....	13	Delay-on-Make Timer.....	27
Return Air Temperature Sensor.....	13	Short Cycle Protection/Delay-on-Break.....	28
Return Air Temperature Alarm.....	14	High Pressure Detection.....	28
Temperature/Humidity Control Operation.....	14	Test Mode.....	28
Cooling Sequence: Economizer Available.....	14	Brownout Protection w/Adjustment.....	28
Economizer Operation in Orphan Mode.....	14	High Pressure Safety Switch.....	29
Cooling Sequence: Economizer Not Available.....	15	Refrigerant High Pressure Alarm.....	29
Heating Sequence.....	15	Phase Monitor.....	29
Staging.....	15	Compressor Operation.....	29
Adjusting Cooling Staging.....	15	Compressor Low Temperature Limit.....	30
Adjusting Heating Staging.....	16	Additional Compressor Alarm.....	30
Dehumidification.....	16	Refrigerant Low Pressure Alarm.....	30
Dehumidification Modes.....	17	Economizer.....	30
Cycling Dehumidification Operation.....	17	Economizer Components.....	30
Electronic Expansion Valve (EEV).....	17	Actuator.....	30
EEV Components.....	17	Dust Sensor.....	31
Electronic Expansion Valve.....	17	Dust Sensor Failure Alarm.....	31
EEV Instructions for Vacuum, Reclaim,		High Dust Limit Alarm.....	31
Charge Unit.....	17	Damper Blade.....	32
System Pressures.....	18	Minimum Damper Position.....	32
Suction Pressure Transducer.....	18	Damper Switch.....	32
Troubleshooting the Suction Pressure		Damper Failed to Open Alarm.....	33
Transducer.....	19	Damper Failed to Close Alarm.....	33
Suction Pressure Alarm.....	19	Outdoor Temperature and Humidity Combination	
Suction Temperature Sensor.....	19	Sensor.....	33
Suction Temperature Alarm.....	19	Outdoor Temperature Sensor Failure Alarm.....	34
Evaporator Freeze Condition Alarm.....	19	Outdoor Humidity Sensor Failure Alarm.....	34
EEV Operation.....	20	Supply Temperature Sensor.....	34
EEV Superheat Control.....	20	Supply Temperature Sensor Failure Alarm.....	34
Additional EEV Alarm.....	20	High Supply Air Temperature Alarm.....	35
Low Superheat Alarm.....	20	Low Supply Air Temperature Alarm.....	35

Economizer Operation	35
Emergency Cooling Mode	37
Emergency Ventilation Mode	37
Model/Serial Number Configuration	37
Electric Heat Option	37
Electric Heat Components	37
Electric Heating Element.....	37
Thermal Overload.....	37
Electric Heat Operation	37
Bard Guard Anti-Theft System Option	37
Unit Disable Option	37
Inverter Option	37
Refrigerant Information	42
General.....	42
Topping Off System Charge.....	42
Safety Practices.....	42
Important Installer Note	42
R410-A Refrigerant Charge.....	42
Pressure Service Ports.....	42
Maintenance.....	44
Standard Maintenance Procedures	44
Bard Guard Anti-Theft System Option	44
Troubleshooting	45
8301-067 Outdoor Temperature/Humidity Sensor.....	45
8301-067 Sensor Connections	45
8301-067 Humidity Sensor Test Value Outputs	48
8301-067 Humidity Sensor Calibration	48
8301-057 Blower Status Switch/Dirty Filter Switch	49
8301-073 Dust (Particulate) Sensor.....	50
8612-061 Dust (Particulate) Sensor Control Board.....	51
8612-061 Control Board Output Signal Not	
Responsive to Dust	51
8408-044 Return Air Sensor/Suction Sensor.....	53
8301-066 Supply Air Sensor	54
8406-157 Liquid Line Pressure Transducer	55
8406-158 Suction Pressure Transducer.....	56

Figures and Tables

Figure 1	TEC-EYE Display and Interface	6
Figure 2	TEC-EYE Connection to Unit Control	6
Figure 3	Quick Menu Icons	8
Figure 4	Cool and Heat Setpoints	8
Figure 5	Orphan Mode Staging	8
Figure 6	Master Staging.....	8
Figure 7	A/C Circuit Measurements	9
Figure 8	Last 24 Operation	9
Figure 9	Software Version.....	9
Figure 10	Changing Unit Address	10
Figure 11	Executing Self Test.....	10
Figure 12	Restoring Factory Default Settings	11
Figure 13	Clearing All Alarms.....	12
Figure 14	Clearing Alarm Logs and Counters.....	12
Figure 15	Changing Zone	13
Figure 16	Adjusting Return Air Sensor	13
Figure 17	Staging	14
Figure 18	Enabling Free Cooling Delay	15
Figure 19	Viewing Unit Stages.....	15
Figure 20	Adjusting Cooling Stage Differentials.....	16
Figure 21	Adjusting Heating Stage Differentials	16
Figure 22	Turning Dehumidification On and Off	16
Figure 23	Overriding EEV Output.....	18
Figure 24	Electronic Expansion Valve and Service Tool	18
Figure 25	Adjusting Suction Pressure Transducer Values..	19
Figure 26	Voltage/Pressure: Suction Pressure Transducer..	19
Figure 27	Adjusting Suction Temperature Sensor Values ..	19
Figure 28	Adjusting Freeze Setpoint and Alarm Delay	20

Figure 29	Putting Blower Output into Override Mode	20
Figure 30	Dirty Filter Switch/Blower Status Switch	22
Figure 31	Verifying Differential Airflow Status	22
Figure 32	Adjusting Air Flow Alarm Delay	22
Figure 33	Enabling High Sensible Mode.....	23
Figure 34	Dirty Filter Switch and Filter Indicator Light.....	24
Figure 35	Verifying Condenser Fan Output.....	25
Figure 36	Fan Blade Setting	25
Figure 37	Adjusting Liquid Pressure Transducer Values....	25
Figure 38	Voltage/Pressure: Liquid Pressure Transducer ...	26
Figure 39	Adjusting Liquid Temperature Values.....	26
Figure 40	Liquid Pressure Control Setpoint.....	27
Figure 41	8201-169 Compressor Control Module	28
Figure 42	Adjusting Compressor Delays.....	29
Figure 43	Adjusting Compressor Low Temp Limit	30
Figure 44	Adjusting Low Pressure Alarm Settings.....	30
Figure 45	Damper Output and Override	31
Figure 46	Dust Sensor.....	31
Figure 47	Adjusting Dust Sensor Alarm Setpoint.....	32
Figure 48	Adjusting Minimum Damper Position	32
Figure 49	Damper Switch	33
Figure 50	Adjusting Damper Alarm Delay	33
Figure 51	Outdoor Air Sensor	34
Figure 52	Outdoor Humidity Sensor	34
Figure 53	Supply Air Sensor.....	34
Figure 54	Adjusting Supply Air Temperature Differential...	35
Figure 55	Economizer 1/2.....	35
Figure 56	Economizer 2/2.....	36
Figure 57	FUSION-TEC WR Series Unit Control Board	39
Figure 58	FUSION-TEC WR Series Nomenclature.....	41
Figure 59	8301-067 Sensor Electrical Connections	45
Figure 60	8301-067 Sensor Terminal Connections.....	45
Figure 61	8301-067 DIP Switch/Output Configuration	48
Figure 62	8301-057 Air Differential Switch Terminals.....	49
Figure 63	8612-061 Dust Sensor Alarm Board.....	51
Figure 64	Dust Sensor Alarm Board Power Supply Check..	52
Table 1	LC6000/TEC-EYE Passwords (Defaults)	6
Table 2	Unit Status Messages	7
Table 3	Software Versioning Guide.....	9
Table 4	Unit Specific Superheat Settings	20
Table 5A	WR35BP* Blower Speeds	21
Table 5B	WR36BP* Blower Speeds	21
Table 5C	WR58BP* Blower Speeds	21
Table 6	Rated Airflow	21
Table 7	Indoor Blower Performance	21
Table 8	Maximum ESP of Operation:	
	Electric Heat Only	21
Table 9	Filter Switch Pressure Settings	23
Table 10	Economizer Default Settings.....	36
Table 11	FUSION-TEC WR Series Board Terminals.....	40
Table 12	Cooling Pressures.....	43
Table 13	8301-067 Sensor: Temperature to	
	Thermocouple Resistance	46
Table 14	8301-067 Sensor: Relative Humidity to	
	Humidity Sensor Current Output.....	47
Table 15	8301-073 Sensor: Dust/Volts	50
Table 16	8408-044 Sensor: Temperature/Resistance	53
Table 17	8301-066 Sensor: Temperature/Resistance	54
Table 18	8406-157 0-650psi Pressure Transducer	55
Table 19	8406-158 0-250psi Pressure Transducer.....	56

GENERAL INFORMATION

Air Conditioning System

This Bard air conditioning system is composed of FUSION-TEC WR Series wall-mounted air conditioners matched with an LC6000 lead/lag controller. The wall mounts are specifically engineered for telecom/motor control center rooms.

NOTE: *The LC6000 lead/lag controller and FUSION-TEC WR Series wall-mount units are designed specifically to work together. The controller cannot run other brands of systems, nor can other controllers run the FUSION-TEC WR Series wall-mount units. They are a complete system, and must be used together.*

Wall-Mount Air Conditioner Units

The wall-mount units operate on VAC power. The units will supply 100% of rated cooling airflow in free cooling mode with ability to exhaust the same amount through the unit itself without any additional relief openings in the shelter.

Each of these units are fully charged with refrigerant and have optional auxiliary heat.

General

The equipment covered in this manual is to be installed by trained, experienced service and installation technicians.

The refrigerant system is completely assembled and charged. All internal wiring is complete.

The unit is designed for use without duct work. Flanges are provided for transition from unit to wall grilles.

These instructions explain the recommended method to install the air cooled self-contained unit and the electrical wiring connections to the unit.

These instructions and any instructions packaged with any separate equipment required to make up the entire air conditioning system should be carefully read before beginning the installation. Note particularly any tags and/or labels attached to the equipment.

While these instructions are intended as a general recommended guide, they do not supersede any national and/or local codes in any way. Authorities having jurisdiction should be consulted before the installation is made. See **Additional Publications** for information on codes and standards.

Sizing of systems for proposed installation should be based on heat loss and heat gain calculations made according to methods of Air Conditioning Contractors of America (ACCA). The supply flange should be installed in accordance with the *Standards of the National Fire Protection Association for the Installation of Air*

Conditioning and Ventilating Systems of Other Than Residence Type, NFPA No. 90A, and Residence Type Warm Air Heating and Air Conditioning Systems, NFPA No. 90B. Where local regulations are at a variance with instructions, installer should adhere to local codes.

Shipping Damage

Upon receipt of equipment, the cartons should be checked for external signs of shipping damage. If damage is found, the receiving party must contact the last carrier immediately, preferably in writing, requesting inspection by the carrier's agent.

These units must remain in upright position at all times.

Additional Publications

These publications can help when installing the air conditioner. They can usually be found at the local library or purchased directly from the publisher. Be sure to consult the current edition of each standard.

National Electrical CodeANSI/NFPA 70
Standard for the Installation of Air Conditioning
and Ventilating SystemsANSI/NFPA 90A
Standard for Warm Air Heating
and Air Conditioning SystemsANSI/NFPA 90B
Load Calculation for Residential Winter
and Summer Air Conditioning ACCA Manual J

For more information, contact these publishers:

Air Conditioning Contractors of America (ACCA)
1712 New Hampshire Ave. N.W.
Washington, DC 20009
Telephone: (202) 483-9370 Fax: (202) 234-4721

American National Standards Institute (ANSI)
11 West Street, 13th Floor
New York, NY 10036
Telephone: (212) 642-4900 Fax: (212) 302-1286

**American Society of Heating, Refrigeration and Air
Conditioning Engineers, Inc. (ASHRAE)**
1791 Tullie Circle, N.E.
Atlanta, GA 30329-2305
Telephone: (404) 636-8400 Fax: (404) 321-5478

National Fire Protection Association (NFPA)
Batterymarch Park
P. O. Box 9101
Quincy, MA 02269-9901
Telephone: (800) 344-3555 Fax: (617) 984-7057

ANSI Z535.5 Definitions:

DANGER: Indicate[s] a hazardous situation which, if not avoided, will result in death or serious injury. The signal word “DANGER” is to be limited to the most extreme situations. DANGER [signs] should not be used for property damage hazards unless personal injury risk appropriate to these levels is also involved.

WARNING: Indicate[s] a hazardous situation which, if not avoided, could result in death or serious injury. WARNING [signs] should not be used for property damage hazards unless personal injury risk appropriate to this level is also involved.

CAUTION: Indicate[s] a hazardous situation which, if not avoided, could result in minor or moderate injury. CAUTION [signs] without a safety alert symbol may be used to alert against unsafe practices that can result in property damage only.

NOTICE: [this header is] preferred to address practices not related to personal injury. The safety alert symbol shall not be used with this signal word. As an alternative to “NOTICE” the word “CAUTION” without the safety alert symbol may be used to indicate a message not related to personal injury.



WARNING

Electrical shock hazard.

Have a properly trained individual perform these tasks.

Failure to do so could result in electric shock or death.

WARNING

Fire hazard.

Maintain minimum 1/4" clearance between the supply flange and combustible materials.

Failure to do so could result in fire causing damage, injury or death.

WARNING

Heavy item hazard.

Use more than one person to handle unit.

Failure to do so could result in unit damage or serious injury.

CAUTION

Cut hazard.

Wear gloves to avoid contact with sharp edges.

Failure to do so could result in personal injury.

USING THE TEC-EYE™

FIGURE 1
TEC-EYE (Bard P/N 8301-059) Display and Interface (Status Screen Shown)



ALARM KEY

Allows viewing of active alarms
Silences audible alarms
Resets active alarms

MENU KEY

Allows entry to Main Menu

ESCAPE KEY

Returns to previous menu level
Cancels a changed entry

UP KEY

Steps to next screen in the display menu
Changes (increases) the value of a modifiable field

ENTER KEY

Accepts current value of a modifiable field
Advances cursor

DOWN KEY

Steps back to previous screen in the display menu
Changes (decreases) the value of a modifiable field

TEC-EYE Hand-Held Diagnostic Tool

The TEC-EYE service tool is used to communicate with the FUSION-TEC unit logic board. By connecting directly to the logic board inside the unit control panel, it is possible to perform diagnostics on the unit, adjust certain settings and verify unit and economizer operation through a self test procedure. **The TEC-EYE service tool is required for unit setup and operation.** The TEC-EYE is supplied with the LC6000 controller but can also be ordered separately (Bard P/N 8301-059).

The menu driven interface provides users the ability to scroll through two menu levels: Quick Menu and Main Menu. The menus permit the user to easily view, control and configure the unit.

The controller is completely programmed at the factory; the default setpoints and their ranges are easily viewed and adjusted from the TEC-EYE display. The program and operating parameters are permanently stored on FLASH-MEMORY in case of power failure.

The TEC-EYE connects to the wall-mount unit control board via an RJ11 modular phone connector as shown in Figure 2.

When not being used, the TEC-EYE hand-held diagnostic tool should be stored inside or near the LC6000 controller. Do not let the TEC-EYE leave the shelter site.

FIGURE 2
TEC-EYE Connection to Unit Control

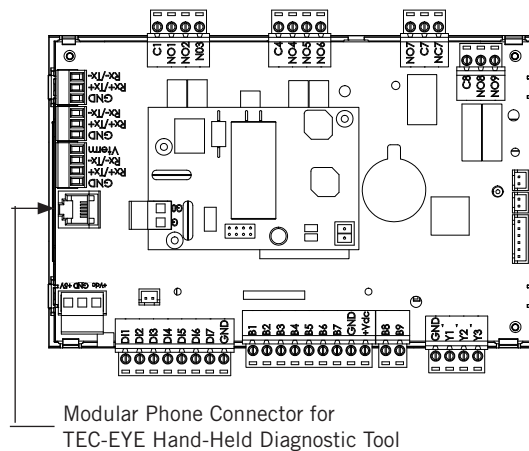

TABLE 1
LC6000/TEC-EYE Passwords (Defaults)

User	2000
Technician	1313
Engineer	9254
Use UP or DOWN keys and ENTER key to enter password	

TEC-EYE Screen Structure and Password Level

Quick Menu

- Setpoints (Orphan Mode Temperature Control)
- Information
- Alarm Log

Main Menu

- System Config: A1-A10 User (2000)
- Adv Sys Config: B1-B8 Technician (1313)
- I-O Config: C1-C15 Technician (1313)
- On/Off: User (2000)
- Alarm Logs: User (2000)
- Settings

- Date/Time: Technician (1313)
- Language: User (2000)
- Import/Export
 - Unit Parameters: Engineer (9254)
 - Alarm Log Export: User (2000)
 - 7 Day Log Export: User (2000)
- Initialization

- Alarm Management: User (2000)
- System Default: Engineer (9254)

- Change Passwords

Logout

In addition to the menu structure above, there are also Status and Alarm screens.

TEC-EYE Acronyms

MAT – Mixed air temperature (calculated value)
 RAT – Return air temperature
 SAT – Supply air temperature
 OAT – Outdoor air temperature
 OAH – Outdoor air humidity
 ODP – Outdoor dew point (calculated value)
 Blower – Indoor blower speed
 Fan – Outdoor fan speed
 Damper – Free cooling damper position
 FC – Free cooling status
 CL1 – Compressor stage 1 status
 CL2 – Compressor stage 2 status
 H1 – Heater stage 1 status
 H2 – Heater stage 2 status
 ST – Number of start requests in last hour

NOTE: *Digital refers to On/Off whereas analog is a variable input.*

Main Status Screen

The Main Status Screen is the default start-up screen and also the return screen after 5 minutes of no activity. The screen can be accessed at any time by pressing the ESCAPE key repeatedly.

The wall-mount unit address is displayed in the upper right corner on the main Main Status Screen (see Figure 1). The Main Status Screen also shows the current date, time, return air temperature (RAT), mixed air temperature (MAT), supply air temperature (SAT), outdoor air temperature (OAT), outdoor air humidity (OAH) and outdoor dew point (ODP) conditions. Blower speed, condenser fan speed, damper position and unit

status are also displayed. See Table 2 for wall-mount unit status messages.

TABLE 2
Unit Status Messages

Message	Description
Waiting...	PLC is on and has not started running the application yet.
Orphan Mode	Unit is on and in orphan mode with no calls for heating or cooling.
LC Online	Unit is on and communicating with the LC6000 with no heating or cooling calls.
Cont. Blower	Unit is operating with continuous blower when no heating or cooling calls are present.
Power Loss	Unit has experienced a loss of main utility power. Alarm only available with inverter units.
Free Cooling	Unit is actively economizing.
Optimized Cool	Unit is mechanical cooling while actively economizing.
Cooling	Unit is actively mechanical cooling.
Heating	Unit is actively heating.
Passive Dehum	Humidity is above the passive setpoint; economizer disabled/ blower speed reduced. See Tables 5A, 5B and 5C on page 21 for dehumidification mode speed.
Active Dehum	Cycling dehumidification is active.
Self Test	Unit is performing a self test.
Off by Alarm	Unit has major fault preventing operation.
Off by DI	Unit is disabled by the local unit disable.
Off by LC	Unit has been turned off by the supervisory controller.
Off by Keyboard	Unit has been turned off by the local user.
Override Active	There is an active override on the system.
Emergency Vent	Unit is in Emergency Ventilation. LC6000 has an active hydrogen alarm.
Emergency Cool	Unit is in Emergency Cooling. Indoor temperatures have exceeded high temp alarms.
Emergency Off	Unit is in Emergency Off. LC6000 Emergency Off input indicates an alarm.

The Quick Menu is accessible from the Main Status Screen. Setpoints, Information and Alarm Log are available through the Quick Menu. Pressing the UP or DOWN keys while on the Main Status Screen will change the Quick Menu icon displayed (see Figure 3). Press the ENTER key when the desired icon is displayed.

FIGURE 3
Quick Menu Icons



NOTE: Screenshots shown in this manual reflect default settings (when applicable).

Quick Menu

Setpoints

From this screen, the local unit heating and cooling setpoints, used for orphan mode operation only, can be changed.

Once the supervisory controller (LC6000) is connected, cooling and heating setpoints will be communicated and local cooling and heating setpoints will be replaced with the communicated cooling and heating setpoints.

If at any time the wall-mount unit(s) loses communication with the LC6000 controller, the wall-mount unit(s) will go into orphan mode and operate using the last communicated setpoints.

To verify or change the wall-mount unit cooling and heating setpoints in orphan mode:

1. Connect the TEC-EYE diagnostic tool to the control board located in the unit.
2. From the Status screen, press UP or DOWN key until Quick Menu displays Setpoints icon. Press ENTER key.
3. Press ENTER key to scroll to the selected choice (see Figure 4).

FIGURE 4
Cool and Heat Setpoints



4. Press UP or DOWN key on desired value until value displays correctly.
5. Press ENTER key to save and scroll to next parameter.
6. Press ESCAPE key until Main Menu screen is displayed.

Information

The information screens are used as a quick reference to show unit operational information such as staging, A/C circuit measurements, last 24 hour run times and software version.

Staging Information

Staging information is used to show if free cooling is available or if any unit operation should be taking place. The look of the staging display depends on if the unit is communicating with a supervisory controller or operating in orphan mode.

Orphan Mode Staging

If the unit is operating in orphan mode, the title will display as **Unit Staging** (see Figure 5). This signifies that the local unit has control of the unit heating and cooling stages.

FIGURE 5
Orphan Mode Staging

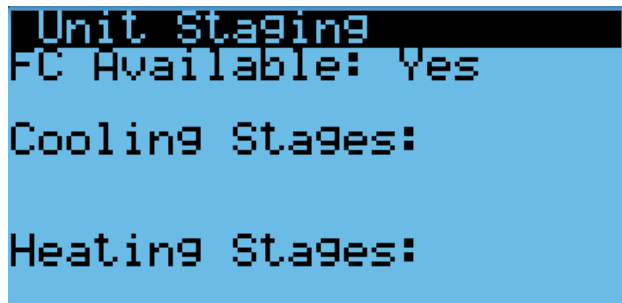

Master Staging

If the unit is communicating with a supervisory controller, the title will display as **Master Staging** (see Figure 6). This signifies that the supervisory controller has control of the unit heating and cooling stages.

FIGURE 6
Master Staging

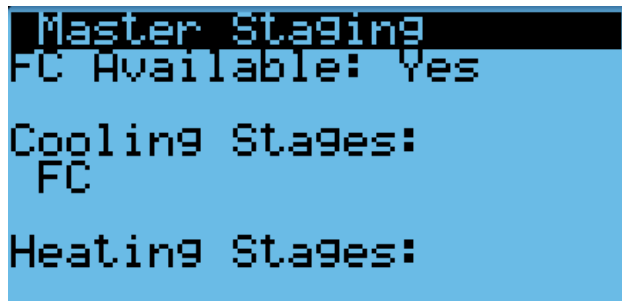

A/C Circuit Measurements

A/C Circuit Information can be found in two screens within the information menu (see Figure 7). The information and measurements provided are liquid line temperature, liquid line pressure, condensing saturated temperature, suction line temperature, suction line pressures, suction saturated temperature, super heat, sub-cooling and electronic expansion valve position.

FIGURE 7
A/C Circuit Measurements

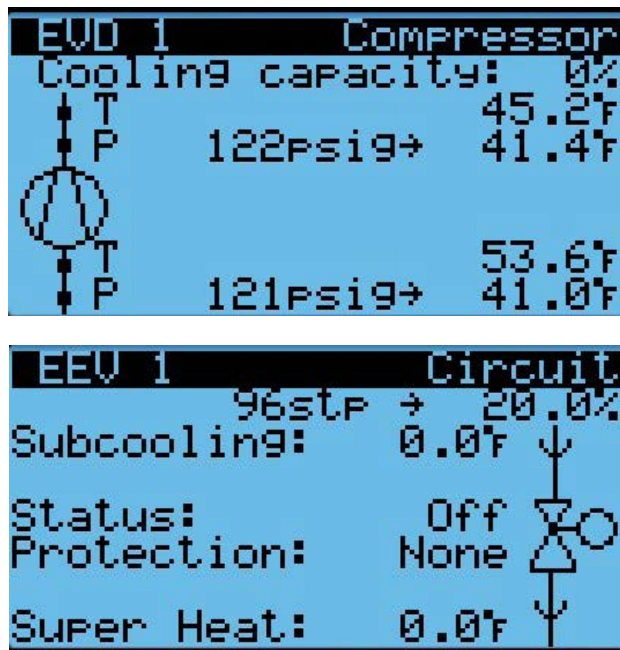

Last 24 Hour Operation

Last 24 Hour Operation information tracks the runtimes (**Time**) of different components or operations in the last 24 hour period (see Figure 8).

FIGURE 8
Last 24 Hour Operation

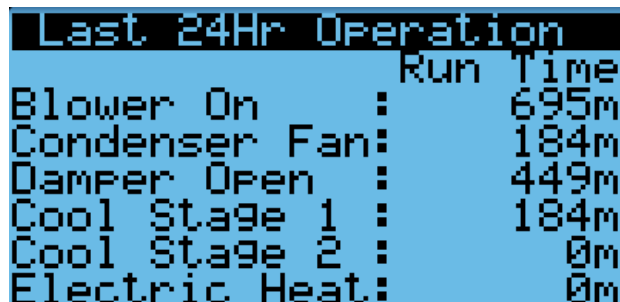

Software Version

The Software Version screen displays the model number of the unit as well as all software version information for the PLC (see Figure 9). This information can be used to determine whether a software update

may be required based on information found in the software change log. This change log can be found at <http://www.bardhvac.com/software-download/>.

FIGURE 9
Software Version

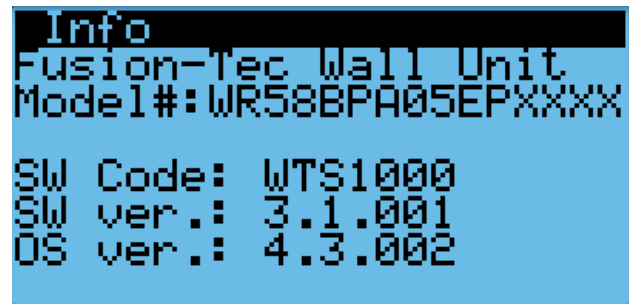

Software Versioning Guide

WTS1000.x.y.z

Software Name: The name of the software is the base part number used to identify which product the software is used in.

TABLE 3
Software Versioning Guide

Product	Software Name
MULTI-TEC	MTS1000
FUSION-TEC (WR)	WTS1000
MEGA-TEC	MGS1000
LC6000	LCS6000

- X: The letter X represents a major change to the software effecting product compatibility or function of the equipment.
- Y: The letter Y represents a minor change to the software that either adds, removes, or alters a feature of the equipment without effecting compatibility with other products.
- Z: The letter Z represents a change to the software that fixes existing features or user interface.

NOTICE

It is important to check the software version during installation to ensure that the latest version has been installed. Current software versions and installation instructions are available on the Bard website at <http://www.bardhvac.com/software-download/>

Alarm Log

The alarm log screens show a log of each alarm. There will be a log for when alarm occurred and if the alarm auto clears, it will show when the alarm cleared.

Addressing Wall-Mount Units

Each unit must have a unique address for the system to operate correctly with the LC controller (Ex: 1, 2, 3, ...14 depending on the number of units). The wall-mount unit address is displayed in the upper right corner on the Status screen on the TEC-EYE display (see Figure 1 on page 6).

To change the unit address:

1. Press MENU key to access the Main Menu screen.
2. Press UP or DOWN keys and ENTER key to enter USER password 2000.
3. Press UP or DOWN keys to scroll to **Sys Config**; press ENTER key.
4. Press ENTER key to scroll to **Unit Address** (see Figure 10).
5. Press UP or DOWN keys to change the address to a value between 1 and 14.
7. Press ENTER key to save.

See page 13 for information on changing unit zone.

FIGURE 10
Changing Unit Address

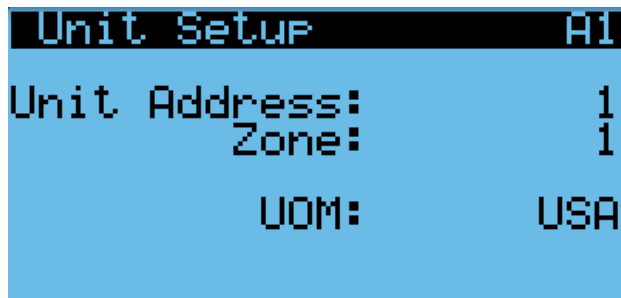

Executing a Self Test

This unit has the ability to perform a self test that will operate all available unit functions in order to quickly determine unit operation. Some unit parameters are adjustable.

To execute a self test:

1. Press MENU key to access the Main Menu screen.
2. Press UP or DOWN keys and ENTER key to enter TECHNICIAN password 1313.
3. Press UP or DOWN keys to scroll to **Sys Config**; press ENTER key.
4. Press UP or DOWN keys to scroll to **Self Test A10** screen.

5. Press ENTER key to scroll to **Enable** parameter (see Figure 11).
6. Press UP or DOWN key to change value to ON. The self test will begin and the screen will display the status of the self test.

FIGURE 11
Executing Self Test

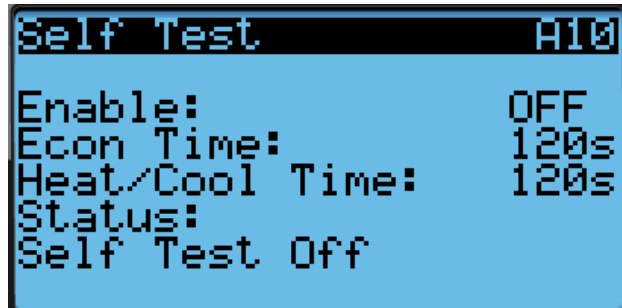

Self Test Parameter Descriptions

Econ Stage Time: Amount of time (in seconds) allowed for damper blade movement in each direction.

Cool Stage Time: Amount of time (in seconds) allowed for each stage of cooling.

Heat Stage Time: Amount of time (in seconds) allowed for heating stage.

Reset to Factory Defaults

To reset to factory default settings:

1. Press MENU key to go to the Main Menu screen.
2. Use UP or DOWN keys and ENTER key to enter ENGINEER password 9254.
3. Press UP or DOWN keys to scroll to **Settings**; press ENTER key.
4. Press UP or DOWN keys to scroll to **Initialization**; press ENTER key.
5. Press UP or DOWN keys to scroll to the **Default Installation** screen.
6. Press ENTER key to scroll to **Reset to Factory Defaults** (see Figure 12).
7. Press UP or DOWN key to change value to **YES**; press ENTER key.
8. System will restart with default values.

FIGURE 12
Restoring Factory Default Settings

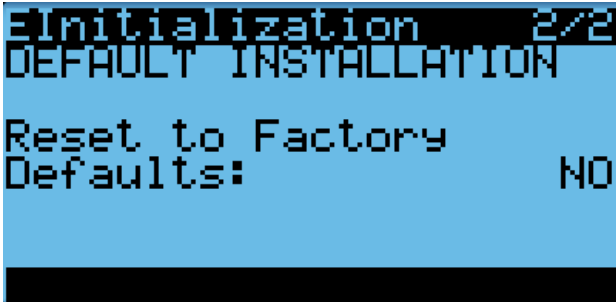

OPERATION

NOTE: Screenshots shown in this manual reflect default settings (when applicable).

Unit On/Off

The wall-mount unit can be turned on and off from the TEC-EYE. Turning the unit off with the following instructions will disable all unit operation.

To turn the unit on or off:

1. Press MENU key to go to the Main Menu screen.
2. Press UP or DOWN keys and ENTER key to enter USER password 2000.
3. Press UP or DOWN keys to scroll to **On/Off**; press ENTER key.
4. Press UP or DOWN keys to change value from On to Off or from Off to On.
5. Press ESCAPE key several times to return to Main Menu screen.

The wall-mount unit may also be turned off by certain alarms. Below is a list of conditions that will disable unit operation to prevent damage to unit or property:

- System Off (set from LC6000)
- Emergency Off (set from LC6000)
- Unit Disable Input
- Invalid Model Number Size
- Return Air Sensor Failure Alarm in Orphan Mode
- Damper Failed to Close Alarm
- No Airflow Alarm
- Power Loss Input Active on Non-Inverter Model Number

Alarm Adjustment

Acknowledging Alarms

Alarm conditions activate a red LED indicator that backlights the ALARM function key. As an option, an alarm condition may also be enunciated by an audible alarm signal. An alarm is acknowledged by pressing the ALARM key. This calls up alarm display screen(s) that provide a text message detailing the alarm condition(s).

Clearing Alarms

Alarms can only be cleared after the alarm condition has been corrected. To clear a single alarm, press and hold the ALARM key for 3 seconds while viewing a specific alarm screen. To clear all alarms, navigate to the screen at the end of the alarm list (shown in Figure 13) and press and hold the ALARM key for 3 seconds.

FIGURE 13
Clearing All Alarms



Clearing Alarm Logs and Counters

To clear the alarm log and alarm counters:

1. Press MENU key to go to the Main Menu screen.
2. Use UP or DOWN keys and ENTER key to enter USER password 2000.
3. Press UP or DOWN keys to scroll to **Settings**; press ENTER key.
4. Press UP or DOWN keys to scroll to **Initialization**. (**Alarm Management 1/2** screen will be displayed.)
5. Press ENTER key to scroll to **Clear Alarm Log** (see Figure 14).
6. Press UP or DOWN key to change value to **YES**; press ENTER key.
7. Press ENTER key to scroll to **Clear Counters**.
8. Press UP or DOWN key to value to **YES**; press ENTER key.

FIGURE 14
Clearing Alarm Logs and Counters

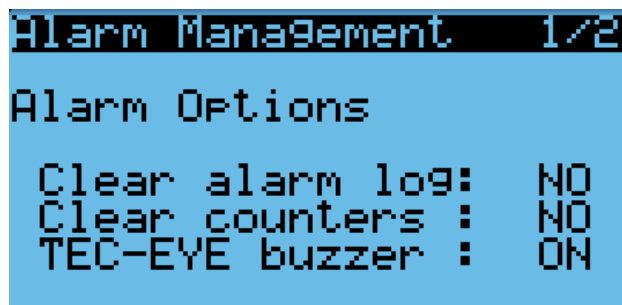

Exporting Alarm Logs

See latest version of Supplemental Instructions manual 7960-815 for information on exporting alarm logs.

Exporting 7 Day Logs

See latest version of Supplemental Instructions manual 7960-816 for information on exporting 7 day I/O logs.

Orphan Mode

FUSION-TEC WR Series wall-mount units have the capability to run without the LC6000 controller attached—this feature is called orphan mode. This keeps the shelter between 60°F and 77°F (factory default settings) by the use of the factory-installed return air sensor in each wall-mount unit. In orphan mode, no auxiliary temperature measurement devices are required for operation. The wall-mount unit automatically uses a continuous blower setting to circulate room air into the return air inlet and uses the return air temperature sensor to control room temperature.

To change default setpoints, refer to **Setpoints** on page 8.

During installation, the ability to run in orphan mode allows deactivation of one of the existing, older wall-mount units, while keeping the shelter cool with the other unit still operating. Once the first of the Bard wall-mount units is installed and powered on, it will operate in orphan mode—keeping the climate inside the shelter stable and the installers comfortable while the remainder of the older equipment is removed and the remaining Bard wall-mount units and LC6000 controller are installed.

Additionally, should any or all of the FUSION-TEC WR Series wall-mount units lose communication with the LC6000 controller (such as during maintenance), they will continue to serve the shelter's needs until a repair can be made.

Zone

When paired with a supervisory controller that uses zones to control groups of wall units, this unit uses the zone setting to relay to the supervisory controller what zone it is set to operate in.

To change the zone:

1. Press MENU key to access the Main Menu screen.
2. Press UP or DOWN keys and ENTER key to enter TECHNICIAN password 1313.
3. Press UP or DOWN keys to scroll to **Sys Config**; press ENTER key.
4. Press UP or DOWN keys to scroll to **Unit Setup A1** screen.
5. Press ENTER key to scroll to **Zone** (see Figure 15).
6. Press UP or DOWN keys to change to the desired value.
7. Press ENTER key to save value.

FIGURE 15
Changing Zone

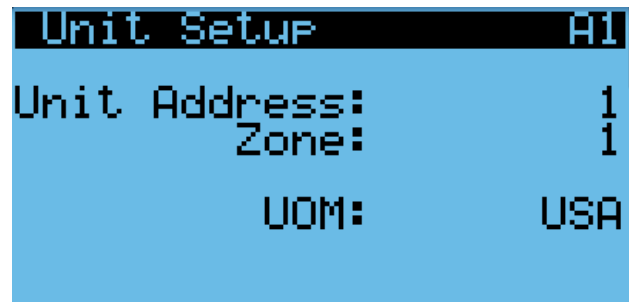

Temperature/Humidity Control

Temperature/Humidity Control Components

Return Air Temperature Sensor

The unit is equipped with a return air temperature sensor to monitor the space temperature when the unit is in orphan mode. The return air sensor is located in the upper part of the return opening in such a way that it is exposed to the entering airstream. An alarm signal will be sent to the LC controller if the return air temperature sensor is disconnected. The temperature is measured with a 10k ohm NTC thermistor.

This sensor can be verified and adjusted by:

1. Press MENU key to go to the Main Menu screen.
2. Press UP or DOWN keys and ENTER key to enter TECHNICIAN password 1313.
3. Press UP or DOWN keys to scroll to **I/O Config**; press ENTER key.
4. Press UP or DOWN keys to scroll to **Return Air Sensor C4**.
5. Verify the measurement displayed on screen is accurate (see Figure 16).

FIGURE 16
Adjusting Return Air Sensor

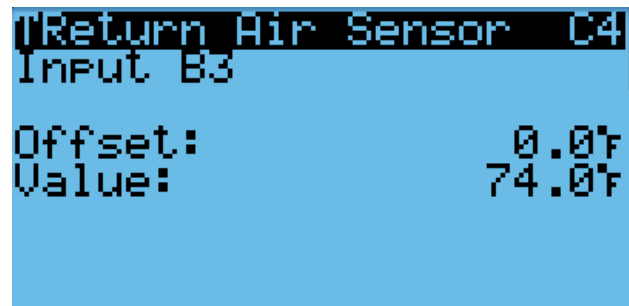

6. If the measurement needs to be adjusted, apply an offset value by pressing ENTER to scroll to **Offset**.
7. Press UP or DOWN keys to adjust the offset.

- The update will not take effect until the cursor is moved out of the **Offset** parameter.
- Once adjusted, press the ESCAPE key several times to return to Main Menu screen.

Return Air Temperature Alarm

When the return air temperature sensor value is out of range (-41.0 to 303.0°F), the controller will generate a sensor failure alarm to indicate the sensor is not working properly.

This alarm is fixed and cannot be adjusted.

Temperature/Humidity Control Operation

When the unit is connected to the LC controller, it will receive all of its heating, cooling and ventilation commands from the controller. When the unit is in orphan mode, it will heat, cool and ventilate based on the return air temperature measurement. The return air temperature will be compared to the cooling setpoint. Based on differentials above and below the setpoint, the available cooling and heating stages will be utilized.

To change or view the unit setpoint:

- From the Status screen, press UP or DOWN key until Quick Menu displays Setpoints icon (). Press ENTER key.

- Press ENTER key to scroll to **Cool Setpoint** or **Heat Setpoint** (see Figure 4 on page 8).
- Press UP or DOWN keys to change the value to desired heating and/or cooling setpoint.

Cooling Sequence – Economizer Available

NOTE: This description is based on the example shown in Figure 17 and Figure 20 (page 16).

If the return air temperature is higher than 79°F (Setpoint of 77°F + Stage 1 On Differential of 2°F) and outdoor conditions are acceptable for economizing, the unit will enable economizer operation (free cooling). If the return air temperature is higher than 80°F (Setpoint of 77°F + Stage 2 On Differential of 3°F), the unit will enable mechanical cooling stage 1. If the return air temperature is higher than 81°F (Setpoint of 77°F + Stage 3 On Differential of 4°F), the unit will enable mechanical cooling stage 2. Each stage will then be disabled when the return air temperature reaches the setpoint plus the stage off differential.

Economizer Operation in Orphan Mode

In orphan mode, there is a chance that the economizer will not be given ample time to operate before the heat load requires more cooling. In this case, there is a delay that can be enabled in order to allow for the most amount of free cooling to be utilized before the compressor is staged on.

FIGURE 17
Staging

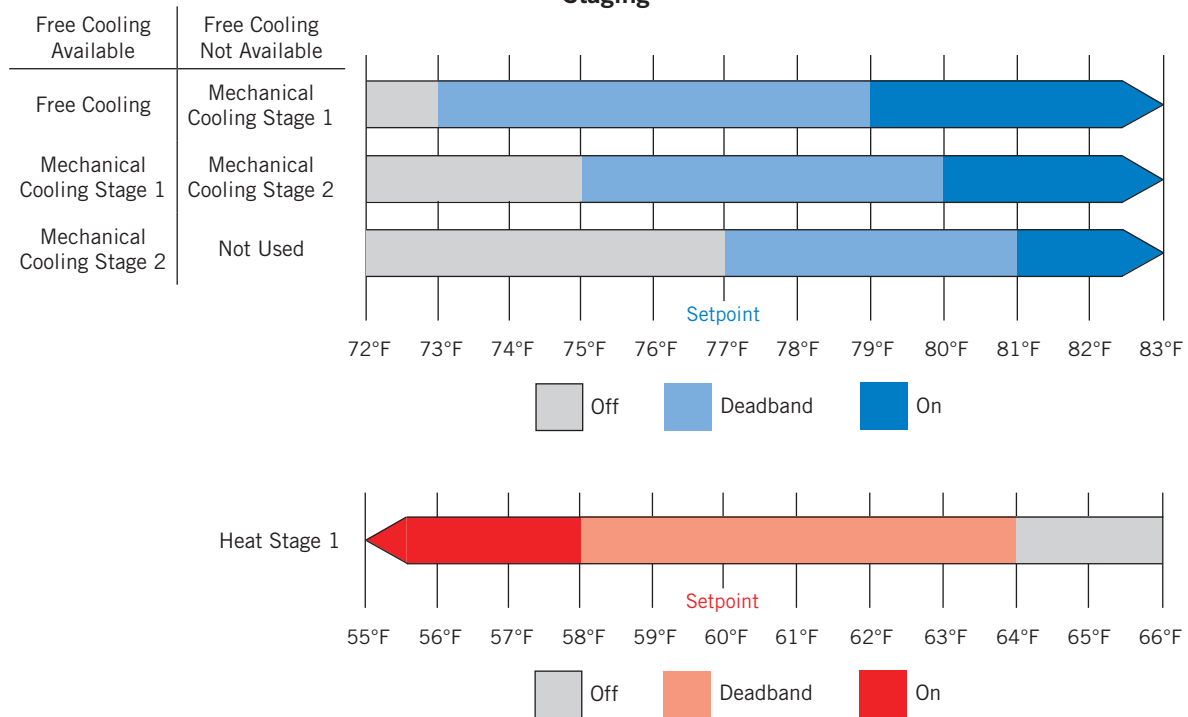

NOTE: Deadband refers to a region where one end limit will turn the heating or cooling function **on** and the opposite end limit will turn the heating or cooling function **off**.

To enable this delay:

1. Press MENU key to go to the Main Menu screen.
2. Press UP or DOWN keys and ENTER key to enter TECHNICIAN password 1313.
3. Press UP or DOWN keys to scroll to **Adv Sys Config**; press ENTER key.
4. Press UP or DOWN keys to scroll to **FC Comp. Delay B7**.
5. Press ENTER key to scroll to **Enable** (see Figure 18).
6. Press UP or DOWN key to change the value.
7. Press ENTER key to save value and move cursor to **Delay**.
8. Press UP or DOWN keys to change the time value.
9. Press ENTER key to save value and move cursor to top of the screen.
10. Press ESCAPE key several times to return to Main Menu screen.

FIGURE 18
Enabling Free Cooling Delay

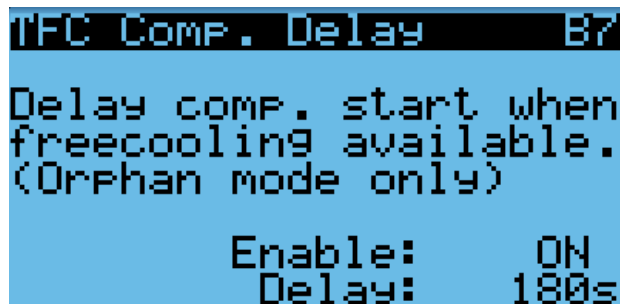

Cooling Sequence – Economizer Not Available

NOTE: This description is based on the example shown in Figure 17 and Figure 20 (page 16).

If the return air temperature is higher than 79°F (Setpoint of 77°F + Stage 1 On Differential of 2°F), the unit will enable mechanical cooling stage 1. If the return air temperature is higher than 80°F (Setpoint of 77°F + Stage 2 On Differential of 3°F), the unit will enable mechanical cooling stage 2. Each stage will then be disabled when the return air temperature reaches the setpoint plus the stage off differential.

Heating Sequence

NOTE: This description is based on the example shown in Figure 17 and Figure 20 (page 16).

If the return air temperature is below 58°F (Setpoint of 60°F + Stage 1 On Differential of -2°F), the unit will enable electric heat stage 1. If the return air temperature is below 57°F (Setpoint of 60°F + Stage 2 On Differential), the unit will enable electric heat stage 2 (if available). Each stage will then be disabled

when the return air temperature reaches the setpoint plus the stage off differential.

Staging

The unit will stage the cooling components based on the cooling demand referenced in the temperature control. The unit will stage the economizer on first if the indoor and outdoor conditions are favorable. The compressor stage 1 will be enabled next as the demand increases. Finally, the compressor stage 2 will be enabled as the demand continues to increase.

The unit is only equipped with one stage of heat and will turn on based on the heating demand.

To view unit stages:

1. From the Status screen, press UP or DOWN key until Quick Menu displays Unit Information icon (). Press ENTER key.
2. The cooling and heating demand are visible on this screen. The unit stages will display here when active as FC, CL1, CL2 or H1 (see Figure 19).

FIGURE 19
Viewing Unit Stages



Adjusting Cooling Staging

This unit uses staging differentials to control cooling operation. The on differential for a stage references the number of degrees above the setpoint at which the stage turns on. The off differential for a stage references the number of degrees below the setpoint at which the stage turns off.

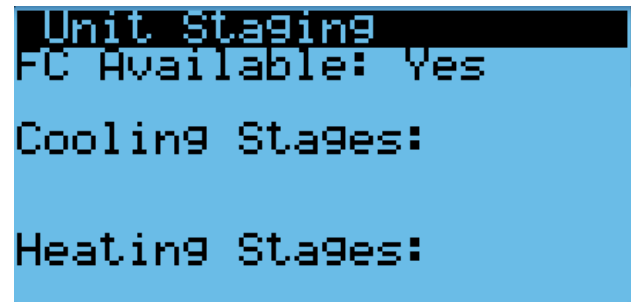
To adjust cooling stage differentials:

1. Press MENU key to go to the Main Menu screen.
2. Press UP or DOWN keys and ENTER key to enter TECHNICIAN password 1313.
3. Press UP or DOWN keys to scroll to **Adv Sys Config**; press ENTER key.
4. Press UP or DOWN keys to scroll to **Cooling Diff. B4**.
5. Press ENTER key to scroll to **Stage 1 On** (see Figure 20 on page 16).
6. Press UP or DOWN keys to adjust number of degrees above setpoint to turn cooling operation on.

7. Press ENTER key to save value and move cursor to **Stage 1 Off**.
8. Press UP or DOWN keys to adjust number of degrees below setpoint to turn cooling operation off.
9. Press ENTER key to save value and move cursor to next stage differential.
10. Repeat steps 6 through 9 for **Stage 2** and **Stage 3** differentials.
11. Press ESCAPE key several times to return to Main Menu screen.

FIGURE 20
Adjusting Cooling Stage Differentials

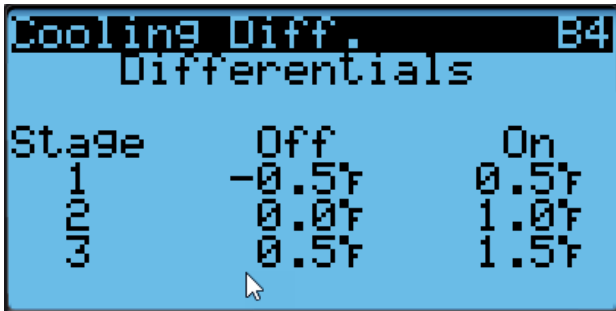

Adjusting Heating Staging

This unit uses staging differentials to control heating operation. The on differential for a stage references the number of degrees below the setpoint at which the stage turns on. The off differential for a stage references the number of degrees above the setpoint at which the stage turns off.

To adjust heating stage differentials:

1. Press MENU key to go to the Main Menu screen.
2. Press UP or DOWN keys and ENTER key to enter TECHNICIAN password 1313.
3. Press UP or DOWN keys to scroll to **Adv Sys Config**; press ENTER key.
4. Press UP or DOWN keys to scroll to **Heating Diff. B5**.
5. Press ENTER key to scroll to **On** (see Figure 21).
6. Press UP or DOWN keys to adjust number of degrees below setpoint to turn heating operation on.
7. Press ENTER key to save value and move cursor to **Off**.
8. Press UP or DOWN keys to adjust number of degrees above setpoint to turn heating operation off.
9. Press ENTER key to save value and move cursor to next stage differential.

10. Press ESCAPE key several times to return to Main Menu screen.

FIGURE 21
Adjusting Heating Stage Differentials

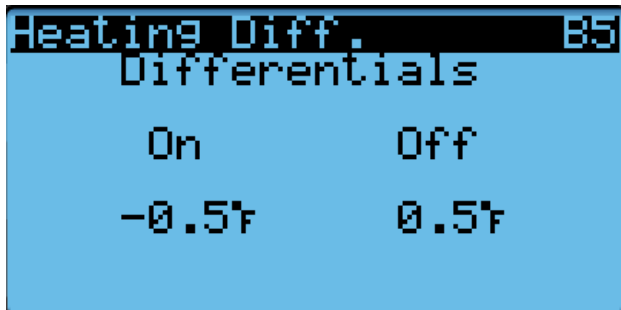

Dehumidification

The unit uses a dehumidification sequence (cycling dehumidification) that does not require the electric heat to run at the same time as the compressor. Instead, the unit will turn on the compressor to cool down to the heating setpoint. Once the lower setpoint has been reached, the unit will heat the space back up to the upper setpoint. This cycle continues until the humidity level in the shelter reaches an acceptable level. At this point, the unit will revert back to normal operation. The economizer will also be disabled while the unit is in the dehumidification mode.

To turn dehumidification on or off:

1. Press MENU key to go to the Main Menu screen.
2. Press UP or DOWN keys and ENTER key to enter TECHNICIAN password 1313.
3. Press UP or DOWN keys to scroll to **Adv Sys Config**; press ENTER key.
4. Press UP or DOWN keys to scroll to **Dehumidification B9**.
5. Press UP or DOWN keys to turn dehumidification on or off (see Figure 22).
6. Press ESCAPE key several times to return to Main Menu screen.

FIGURE 22
Turning Dehumidification On or Off

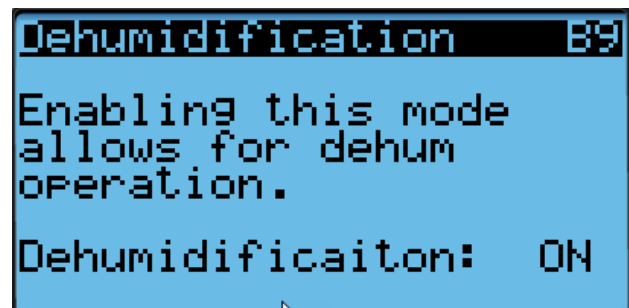

Dehumidification Modes

Dehumidification Off

When the humidity level inside a zone falls to the Dehumidification Off setpoint, the system will stop attempting to dehumidify the space. The default setpoint value for this mode is 60% RH.

Passive Dehumidification

When the humidity level rises to the Passive Dehumidification setpoint, the controller will activate staged dehumidification at the available wall units. As the humidity level rises to the passive dehumidification setpoint, the free cooling function (economizer) is disabled. When there is a call for cooling, the compressor will energize and the blower speed will be reduced to the unit dehumidification mode or Balanced Climate speed whichever is applicable to the unit. All units allowed to run within the zone will be given the dehumidification command and will operate as such on a call for cooling. The default setpoint value for passive dehumidification is 70% RH.

Active Dehumidification

When the humidity level rises to the Active Dehumidification setpoint, the supervisory controller will active staged dehumidification at the available wall units. The supervisory controller will then calculate the dehumidification demand based on how far above the setpoint and how long the RH level has been above the setpoint. The controller will then utilize all of the units with active dehumidification capabilities to reduce the indoor humidity level. The units will be staged on based on the existing cooling rotation for the units in the zone up to the maximum number of units allowed to run. When in demand minimum compressor run time is applicable, examples of demand are as follows:

With two units with dehumidification capabilities, Unit 1 in rotation will come on at 50% demand and Unit 2 in rotation will come on at 100% demand. They will rotate off in a reverse; Unit 2 will be off at 50% demand and Unit 1 will be off at the dehumidification off setpoint.

With three units with dehumidification capabilities, Unit 1 in rotation will come on at 33% demand, Unit 2 in rotation will come on at 67% demand and Unit 3 in rotation will come on at 100% demand. They will rotate off in reverse; Unit 3 will be off at 67% demand, Unit 2 will be off at 33% demand and Unit 1 will be off at dehumidification off setpoint.

An active dehumidification sequence will run until the space temperature falls to the heating setpoint or increases to the cooling setpoint, or the dehumidification off setpoint is reached. Refer to the specific unit manual for active dehumidification sequence and space temperature control.

The passive dehumidification setpoint must be lower than the active dehumidification setpoint to ensure the economizer is disabled during active dehumidification.

Availability for active dehumidification will be determined by model number. Units with electric reheat, mechanical dehumidification or cycling reheat will be considered. The active dehumidification default setpoint is 80% RH.

Cycling Dehumidification Operation

On a call for active dehumidification from the supervisory control, the wall unit will enter cycling dehumidification mode and economizer free cooling operation will be discontinued during cycling reheat. If at any time the unit receives a heat or cooling call while in cycling dehumidification mode, the unit will exit cycling dehumidification until the heating or cooling call is satisfied.

During cycling dehumidification, the return air sensor is used to determine operation of the cycling dehumidification. When the unit enters cycling dehumidification mode and the return temperature is above 55°F, the unit compressor will come on with a reduced blower speed. The blower speeds are referenced in tables 5A, 5B, and 5C on page 21 as Dehumidification Mode; these speeds are unit specific. The unit will continue to operate in this fashion until the return air temperature falls to 55°F at which time the compressor will be deactivated. After a 5-10 second delay, the electric heat will energize and the blower will go to rated speed for electric heat. The unit will continue to utilize electric heat until the return air temp rises to 2°F below the cooling setpoint and then return to compressor operation with the blower at dehumidification mode speed. If the unit enters cycling dehumidification mode and the return air is below 55°F, the unit will begin the sequence with the heating mode as described.

A call for cycling dehumidification is ignored if there is a call for emergency vent, emergency cool or emergency off.

NOTE: This feature is dependent upon the LC6000 indoor humidity sensors and a command from the LC to enter dehumidification mode. See the latest revision of LC6000 Service Instructions 2100-669 for adjustment of the dehumidification setpoint and differentials.

Electronic Expansion Valve (EEV)

EEV Components

Electronic Expansion Valve

The electronic expansion valve is a stepper motor that is controlled with a step output from the controller. The valve is capable of 480 steps represented by a 0-100% signal on the controller. The motor drives a needle valve that regulates the flow of refrigerant.

EEV Instructions for Vacuum, Reclaim, Charge Unit

The electronic expansion valve moves to the 40% open position when the unit is not actively cooling. The valve

may need to be manually positioned for service or troubleshooting. The valve can be positioned by using a menu override.

To manually override the valve:

NOTE: The unit must be off to perform this override.

1. Press MENU key to go to the Main Menu screen.
2. Press UP or DOWN keys and ENTER key to enter TECHNICIAN password 1313.
3. Press UP or DOWN keys to scroll to **I/O Config**; press ENTER key.
4. Press UP or DOWN keys to scroll to **EEV Service C15**.
5. Press ENTER key to scroll to **Enable** (see Figure 23).
6. Press UP or DOWN key to change **Disable** to **Enable**.
7. Press ENTER key to scroll to **Position**.
8. Press UP or DOWN keys to adjust to the desired value.
9. Press ENTER key to save.

FIGURE 23
Overriding EEV Output

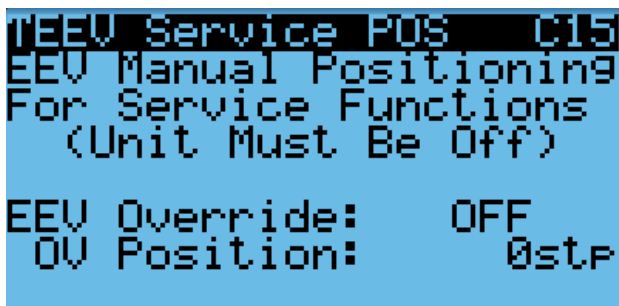

The valve can also be opened or closed using the EEV service tool (Bard Part # 2151-021). This magnetic EEV service tool (shown in Figure 24) is used to manually open the EEV. To do this, remove the EEV stator coil (red color with retaining nut on top), slide the magnetic tool over the shaft where the stator was removed and turn in a clockwise direction to open the valve to the full open position (directional arrows are provided on the tool). Opening the valve to the full open position will aid in the refrigerant reclamation and evacuation processes.

With the stator removed, the resistance should be 40 ohms +/- 10%. There are two sets of three wires that will have this resistance.

Reapply the EEV stator coil and retaining nut. Upon powering the unit back up, the control board will automatically drive the EEV back to the fully shut position, and then back to the 40% open position prior to starting the compressor back up. Once the compressor starts, the control board will again modulate the EEV position to control the system superheat.

FIGURE 24
Electronic Expansion Valve (EEV) and Service Tool

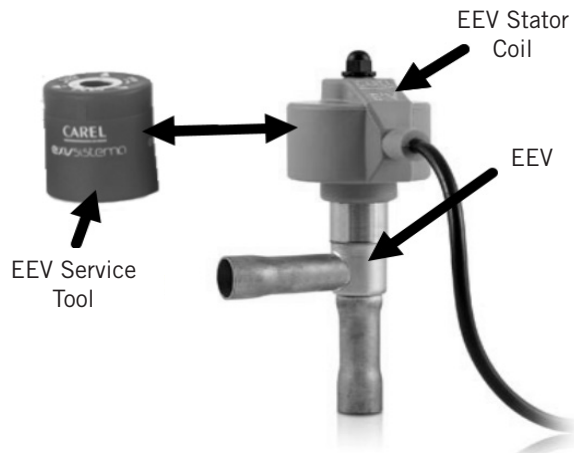

System Pressures

To view system pressure and temperatures during this process:

1. From the Status screen, press UP or DOWN key until Quick Menu displays Information icon (). Press ENTER key.
2. Press UP or DOWN keys to scroll to **EEV 1 Circuit** and **EVD 1 Compressor** screens (see Figure 7 on page 9).
3. Reference the **Pressures** and **Temperatures** on **EVD 1 Compressor** and the **Superheat** and **Subcooling** on **EEV 1 Circuit**.

Suction Pressure Transducer

The unit has a pressure transducer installed on the suction line between the evaporator coil and compressor. The transducer is used for system monitoring of suction system pressures. The sensor is used with the suction temperature sensor to provide a real time superheat calculation that determines the EEV position.

This sensor can be verified and adjusted by:

1. Press MENU key to go to the Main Menu screen.
2. Press UP or DOWN keys and ENTER key to enter TECHNICIAN password 1313.
3. Press UP or DOWN keys to scroll to **I/O Config**; press ENTER key.
4. Press UP or DOWN keys to scroll to **Liquid Pr Sensor C9**.
5. Verify the measurement displayed on screen is accurate (see Figure 25).
6. If the measurement needs to be adjusted, apply an offset value by pressing ENTER to scroll to **Offset**.
7. Press UP or DOWN keys to adjust the offset.
8. The update will not take effect until the cursor is moved out of the **Offset** parameter.

- Once adjusted, press the ESCAPE key several times to return to Main Menu screen.

FIGURE 25
Adjusting Suction Pressure Transducer Values

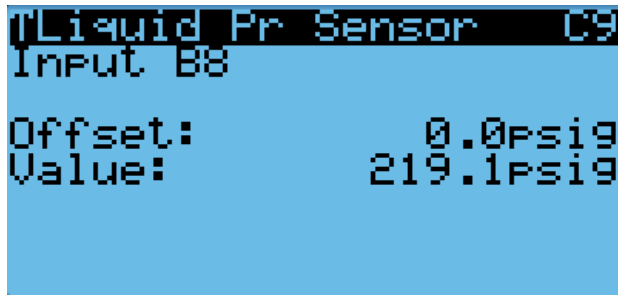

Troubleshooting the Suction Pressure Transducer

0-250 psig

-5v Nominal .5 – 4.5v Actual

4v/250 psig = .016 volts per 1 psig

Example: 125 psig x .016 + .5 volts = 2.5 volts

Formula for Tech:

Measured Pressure x .016 + Sensor Offset = Expected Transducer Signal Voltage (see Figure 26).

FIGURE 26
Voltage to Pressure: Suction Pressure Transducer

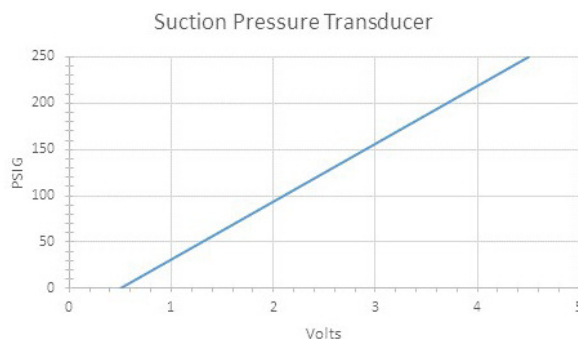

Suction Pressure Alarm

When the suction pressure transducer value is out of range (0-250 PSIG) and the compressor is running, the controller will generate a sensor failure alarm to indicate the sensor is not working properly.

This alarm cannot be adjusted.

Suction Temperature Sensor

The suction temperature sensor is used to calculate superheat. The EEV uses this value to control the EEV. The temperature is measured with a 10k ohm NTC thermistor.

The suction temperature sensor measurement can be verified and adjusted by:

- Press MENU key to go to the Main Menu screen.

- Press UP or DOWN keys and ENTER key to enter TECHNICIAN password 1313.
- Press UP or DOWN keys to scroll to **I/O Config**; press ENTER key.
- Press UP or DOWN keys to scroll to **Suct Temp Sensor C8**.
- Verify the measurement displayed on screen is accurate (see Figure 27).
- If the measurement needs to be adjusted, apply an offset value by pressing ENTER to scroll to **Offset**.
- Press UP or DOWN keys to adjust the offset.
- The update will not take effect until the cursor is moved out of the **Offset** parameter.

FIGURE 27
Adjusting Suction Temperature Sensor Values

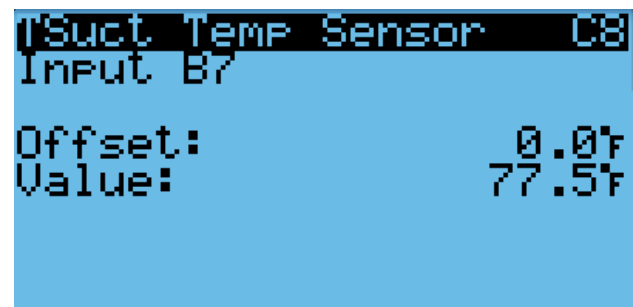

Suction Temperature Alarm

When the suction temperature sensor value is out of range (-41.0 to 303.0°F), the controller will generate a sensor failure alarm to indicate the sensor is not working properly.

This alarm cannot be adjusted.

Evaporator Freeze Condition Alarm

The freeze alarm (evaporator coil freeze protection) uses the suction temperature sensor to alarm and manage operation when conditions are favorable for an evaporator coil freeze condition. Whenever the compressor is running, the system will constantly monitor the suction line temperature. If the suction line temperature falls below the freeze setpoint (32°F factory default) for a period of time exceeding freeze alarm delay time (120 seconds factory default), the system will alarm a freeze condition. Once a freeze condition is triggered, the system will stop the compressor operation and increase the blower speed to 80% in order to rapidly warm and thaw the evaporator coil. After the coil has reached a temperature above the freeze alarm reset temperature setpoint (55°F factory default) for a period of time exceeding the freeze alarm reset hold time (5 minutes factory default), normal operation will continue.

To adjust the freeze setpoint and/or alarm delay time:

- Press MENU key to go to the Main Menu screen.

2. Press UP or DOWN keys and ENTER key to enter USER password 2000.
3. Press UP or DOWN keys to scroll to **System Config**; press ENTER key.
4. Press UP or DOWN keys to scroll to **Alarm Setup A7**.
5. Press ENTER key to scroll to **Alarm Setpoint** (see Figure 28).
6. Press UP or DOWN keys to change to the desired value.
7. Press ENTER key to save the value and move cursor to **Alarm Delay**.
8. Press UP or DOWN keys to change to the desired **Alarm Delay** value.
9. Press ENTER key to save the value.

FIGURE 28
Adjusting Freeze Setpoint and Alarm Delay

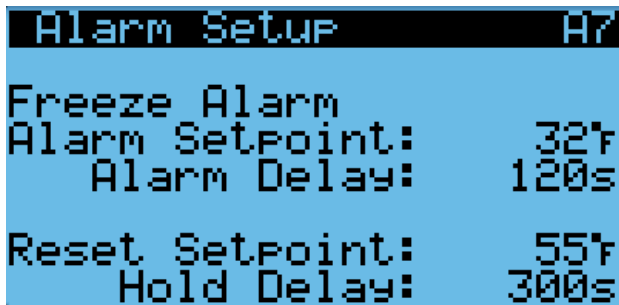

EEV Operation

EEV Superheat Control

The electronic expansion valve (EEV) will modulate to maintain a specific superheat (see Table 4) while the compressor is running. When the compressor is not running, the valve will open to 40% to allow system equalization.

TABLE 4
Unit Specific Superheat Settings

Unit Size	Target Superheat
WR35	11°F
WR36	11°F
WR58	12°F

There are two forms of low superheat protection on the FUSION-TEC WR Series units. One form will be active once the superheat value is at or below 5°F. At this point, the control will aggressively close the valve to prevent flood back. The second form occurs at low ambient temperatures. This control will slightly raise the superheat setpoint based on outdoor temperature to prevent system instability.

Additional EEV Alarm

Low Superheat Alarm

This alarm will become active when the calculated superheat goes below 5°F. This alarm will clear itself when the condition is no longer present.

This alarm cannot be adjusted.

Indoor Airflow

Indoor Airflow Components

Blower

The unit is equipped with a blower that is driven by an electronically commutated motor (ECM). This blower is controlled by a 0-10v signal provided from the controller. This 0-10v signal is converted to a PWM signal with an adapter. The blowers on both the WR36BP* and WR58BP* models use a 10" diameter wheel. The WR36BP* operates between 250-850 rpm while the WR58BP* operates between 250-1400 rpm.

The blower output can be put into an override mode for verification or troubleshooting. The override will last for 5 minutes or until the **Blower Override** parameter is set to **OFF** again.

To put the blower into override:

1. Press MENU key to go to the Main Menu screen.
2. Press UP or DOWN keys and ENTER key to enter TECHNICIAN password 1313.
3. Press UP or DOWN keys to scroll to **I/O Config**; press ENTER key.
4. Press UP or DOWN keys to scroll to **Blower Output C12**.
5. Press ENTER key to scroll to **Blower Override** (see Figure 29).

FIGURE 29
Putting Blower Output into Override Mode

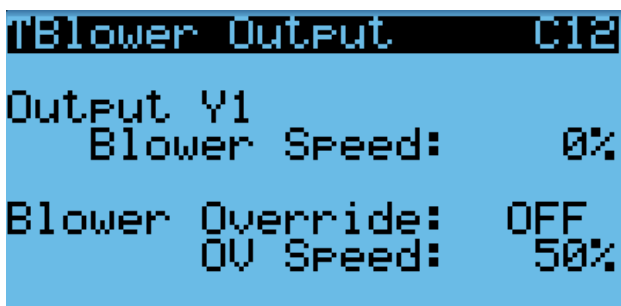

6. Press UP or DOWN key to change **OFF** to **ON**.
7. Press ENTER key to scroll to **OV Speed**.
8. Press UP or DOWN keys to adjust the speed to the desired output. See Table 5A, 5B or 5C.
9. Press ENTER key to save.

NOTE: If unit is operating at the time the blower override is being enabled, adjustments must be made to **OV Speed** first before switching **Blower Override** on.

TABLE 5A
WR35BP* Blower Speeds

Mode	Speed Percentage	Controller Output Volts	CFM
High Sensible Full Load Cooling	80.0	8.0 v	1400
High Sensible Part Load Cooling	48.0	4.8 v	1040
Standard Full Load Cooling	55.0	5.5 v	1120
Standard Part Load Cooling	36.0	3.6 v	900
Economizer Standard	80.0	8.0 v	1200
Economizer High S/T	100.0	10.0 v	1620
Heating	41.0	4.1 v	900
Dehumidification Mode	20.0	2.0 v	500

TABLE 5B
WR36BP* Blower Speeds

Mode	Speed Percentage	Controller Output Volts	CFM
High Sensible Full Load Cooling	94.0	9.4 v	1500
High Sensible Part Load Cooling	54.0	5.4 v	1100
Standard Full Load Cooling	63.0	6.3 v	1200
Standard Part Load Cooling	43.0	4.3 v	950
Economizer Standard	90.0	9.0 v	1450
Economizer High S/T	63.0	6.3 v	1200
Heating	63.0	6.3 v	1200
Dehumidification Mode	19.0	1.9 v	470

TABLE 5C
WR58BP* Blower Speeds

Mode	Speed Percentage	Controller Output Volts	CFM
High Sensible Full Load Cooling	75.0	7.5 v	2180
High Sensible Part Load Cooling	50.0	5.0 v	1705
Standard Full Load Cooling	55.0	5.5 v	1830
Standard Part Load Cooling	35.0	3.5 v	1335
Economizer Standard	45.0	4.5 v	1600
Economizer High S/T	75.0	7.5 v	1950
Heating	35.0	3.5 v	1335
Dehumidification Mode	35.0	3.5 v	1335

TABLE 6
Rated Airflow

	Nominal Rated CFM		Nominal Rated ESP
	High	Low	
WR35BP*	1100	900	0.00
WR36BP*	1200	950	0.00
WR58BP*	1800	1400	0.10

TABLE 7
Indoor Blower Performance

	Speed ESP (Inch H ₂ O)	High		Low	
		Dry Coil	Wet Coil	Dry Coil	Wet Coil
WR35BP*	0.00	1150	1100	940	900
WR36BP*	0.00	1260	1200	995	950
WR58BP*	0.10	1885	1800	1470	1400

TABLE 8
Maximum ESP of Operation
Electric Heat Only

Model	Static Pressure*
-A0Z	.00"
-A05	.00"
-B0Z	.00"
-B06	.00"

* Unit is rated for free blow non-ducted operation with SGR-5W Supply Grille and RGR-5W Return Grille.

Blower Status Switch

The unit is equipped with a differential pressure airflow switch to monitor the blower (see Figure 32). If the blower is turned on and the switch doesn't close to indicate there is differential pressure between the inlet and outlet of the blower, an alarm will be generated. For switch settings, see Figure 30.

Differential airflow status can be viewed by:

1. Press MENU key to go to the Main Menu screen.
2. Press UP or DOWN keys and ENTER key to enter TECHNICIAN password 1313.
3. Press UP or DOWN keys to scroll to **I/O Config**; press ENTER key.
4. Press UP or DOWN keys to scroll to **Digital In Config C1**.
5. Reference **7 NoAir** row and **Val** column (see Figure 31).

FIGURE 30
Dirty Filter Switch and Blower Status Switch

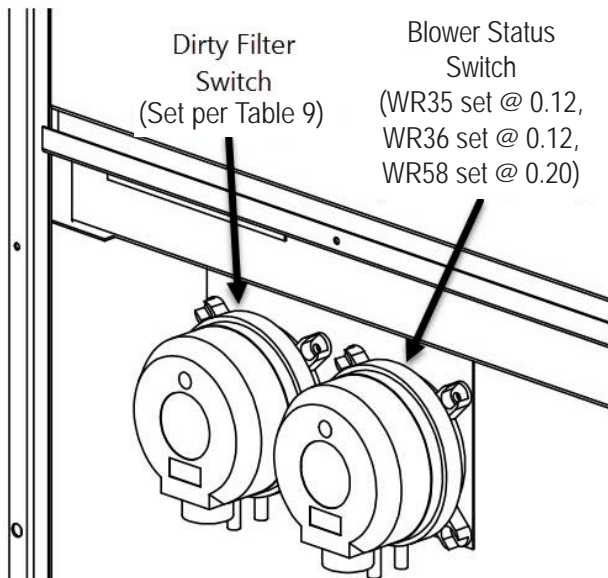

FIGURE 31
Verifying Differential Airflow Status

Digital In Config C1			
Channel	En	Dir	Val
Disable	OFF	N/O	OFF
Filter	ON	N/O	OFF
CCM	ON	N/O	OFF
PwrLoss	ON	N/C	OFF
Damper	ON	N/C	OFF
Airflow	ON	N/O	ON

Blower Status Alarm

If the blower is commanded on and the fan status switch (differential pressure) has not indicated the fan is running within 45 seconds, the system will generate an alarm.

Disabling the blower status switch in **I/O Config** disables this alarm.

This alarm is just a notification and will clear itself when the conditions are no longer present.

To adjust the air flow alarm delay:

1. Press MENU key to go to the Main Menu screen.
2. Press UP or DOWN keys and ENTER key to enter USER password 2000.
3. Press UP or DOWN keys to scroll to **System Config**; press ENTER key.
4. Press UP or DOWN keys to scroll to **Alarm Setup A8**.
5. Press ENTER key to scroll to **Air Flow Alarm Del** (see Figure 32).
6. Press UP or DOWN keys to change to the desired value.
7. Press ENTER key to save the value.

FIGURE 32
Adjusting Air Flow Alarm Delay

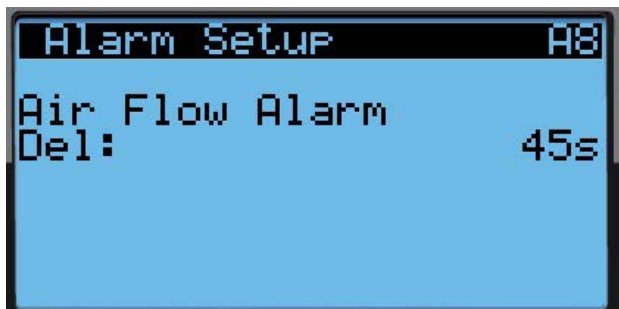

Filters

The unit is equipped with two (2) 20" x 30" x 2" MERV 8 filters. The filters slide into position making them easy to service. The filters can be serviced from the outside by removing either the right or left filter access panel.

Dirty Filter Switch

These units are equipped with a differential pressure switch to indicate when the filter(s) needs to be replaced (see Figure 30). The dirty filter switch measures the pressure difference across the filter through silicone tubing routed to the blower and vent areas of the unit.

The switch circuit consists of a *normally open* filter pressure switch. The switch will open when the pressure differential goes above the setting indicated on the dial. When the pressure difference returns below the setting on the dial, the switch will close.

Adjustment of dirty filter switch may be necessary to ensure proper operation. See Table 9 and Figure 34 on page 24 to aid in setting the filter switch to operate at different percentages of filter blockage.

Dirty Filter Alarm

The wall-mount unit is equipped with a differential pressure switch input to the controller (see Figure 32). When the switch indicates a dirty filter, the controller will generate an alarm. Once the condition is no longer present, the alarm will automatically clear. Additionally, an indicator light will be turned on with the alarm and turned off when the alarm clears (see Figure 34 on page 24).

Disabling the dirty filter switch in **I/O Config** disables this alarm.

The threshold of this alarm is adjusted by changing the settings on the switch (see Table 9).

Filter Indicator Light

These units are equipped with a 24v indicator light mounted on side of unit that displays the current status of the filter (see Figure 36 on page 24). When the light is on, the filter needs to be replaced. Once the filter(s) has been changed, the indicator light will turn off.

Indoor Airflow Operation

High Sensible Mode

High sensible mode allows for higher airflow through the indoor air section. In this mode, air circulation is increased through the cooled space, but less moisture is removed from the air circulating through the unit.

NOTE: High sensible enable on the wall-mount unit will only toggle high sensible mode during orphan mode operation. When connected to the LC6000 controller, the high sensible mode will be overridden by the controller operation.

To change these settings:

1. Press MENU key to go to the Main Menu screen.
2. Press UP or DOWN keys and ENTER key to enter TECHNICIAN password 1313.
3. Press UP or DOWN keys to scroll to **Adv System Config**; press ENTER key.
4. Press UP or DOWN keys to scroll to **Blower CFM Mode B6**.
5. Press ENTER key to scroll to **High Sensible** (see Figure 33).

FIGURE 33
Enabling High Sensible Mode

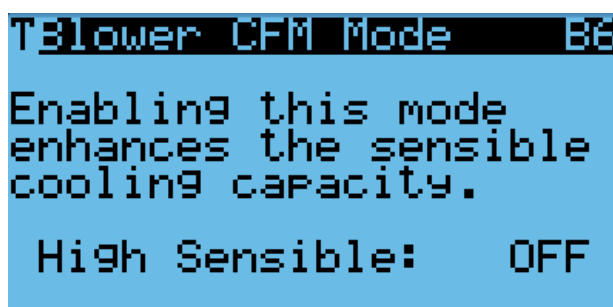

TABLE 9
Filter Switch Pressure Settings

Unit	Filter Blockage %	0%	10%	20%	30%	40%	50%	60%	70%
WR35BP* (Default) High S/T	Switch Static Setting	0.65	0.70	0.75	0.85	0.95	1.05	1.25	1.50
	Evaporator Airflow %	100%	99.0%	97.0%	96.4%	95.5%	92.7%	88.1%	80.6%
WR35BP* Standard	Switch Static Setting	0.40	0.43	0.45	0.50	0.55	0.65	0.75	0.90
	Evaporator Airflow %	100%	99.7%	98.7%	96.8%	96.0%	94.4%	91.6%	85.2%
WR36BP* (Default) High S/T	Switch Static Setting	0.12	0.12	0.12	0.20	0.20	0.35	0.35	0.40
	Evaporator Airflow %	100%	99.3%	99.4%	98.7%	96.5%	92.1%	91.3%	87.9%
WR36BP* Standard Airflow	Switch Static Setting	0.12	0.12	0.12	0.12	0.20	0.20	0.20	0.30
	Evaporator Airflow %	100%	99.3%	99.4%	98.8%	97.3%	91.5%	89.8%	88.3%
WR58BP* (Default) High S/T	Switch Static Setting	0.40	0.50	0.60	0.70	0.75	0.80	0.90	1.00
	Evaporator Airflow %	100%	98.7%	98.1%	97.5%	91.7%	81.3%	79.1%	78.6%
WR58BP* Standard Airflow	Switch Static Setting	0.30	0.35	0.40	0.45	0.50	0.65	0.70	0.90
	Evaporator Airflow %	100%	99.8%	99%	98.5%	96.8%	89.9%	84%	82.2%

All units tested equipped with MERV 8 filters. Appropriate supply (SG) and return (RG) grilles installed during testing. Pressure switch adjustment may be necessary due to variations in filter type, installation and room pressure.

Bard recommends filter switch be set at 50% filter blockage or less. Higher settings may significantly hinder unit performance.

FIGURE 34
Dirty Filter Switch and Filter Indicator Light

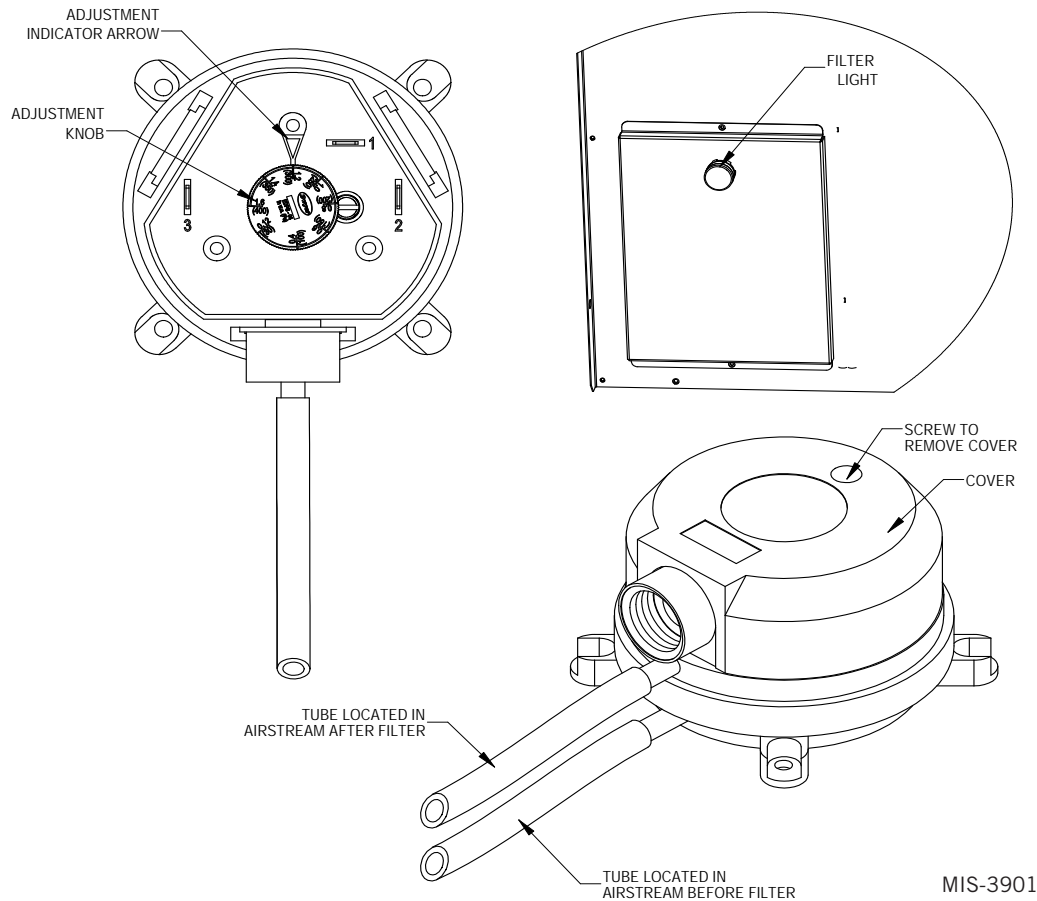

6. Press UP or DOWN keys to change **ON** or **OFF** value.
7. Press ENTER key to save.

Blower Speed Control

The blower is capable of changing speeds to best match the requirements of the system depending on which mode the system is in (see Table 5A, 5B or 5C on page 21).

The unit will automatically switch to the required speed for each mode. High sensible mode and dehumidification mode are both communicated separately from the LC. For more information on the high sensible command from LC, please see LC6000 Service Instructions 2100-669.

Additional Indoor Airflow Alarms

Supply Air Temperature Alarm

When the supply air temperature sensor value is out of range (-41.0 to 303.0°F), the controller will generate a sensor failure alarm to indicate the sensor is not working properly.

This alarm is fixed and cannot be adjusted.

Condenser Fan

Condenser Fan Components

Condenser Fan

The unit is equipped with a condenser fan that is driven by an electronically commutated motor (ECM). This fan is controlled by a 0-10v signal provided from the controller. The fan operates between 100-1200 rpm.

To view the output of the condenser fan:

1. Press MENU key to go to the Main Menu screen.
2. Press UP or DOWN keys and ENTER key to enter TECHNICIAN password 1313.
3. Press UP or DOWN keys to scroll to **I/O Config**; press ENTER key.
4. Press UP or DOWN keys to scroll to **Cond. Fan Output C14**.
5. Reference **Fan Speed** parameter for the current output to the condenser fan (see Figure 35).

FIGURE 35
Verifying Condenser Fan Output

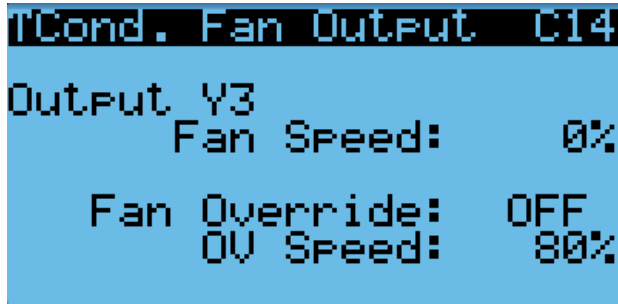

If required, the condenser fan output can be manually set for 5 minutes for troubleshooting purposes. The override will last for 5 minutes or until the **Fan Override** parameter is set to **OFF** again.

To put the condenser fan into override:

1. Press ENTER key to scroll to the **Fan Override** parameter (see Figure 35).
2. Press UP or DOWN keys to change the value from **OFF** to **ON**.
3. Press ENTER key to save the value and move cursor to **OV Speed**.
4. Press UP or DOWN keys to change the value to the desired override speed.
5. The fan should now run at the selected speed. The output can be verified by again referencing the **Fan Speed** parameter.

NOTE: *If unit is operating at the time the fan override is being enabled, adjustments must be made to **OV Speed** first before switching **Fan Override** on.*

Due to design considerations of the condenser section of the wall-mount unit, placement/clearance of the motor/fan blade is critical to heat dispersal. Should a change of motor or fan blade be necessary, see Figure 36 for proper clearance adjustment.

FIGURE 36
Fan Blade Setting

.75" (from the closest point on the fan blade)

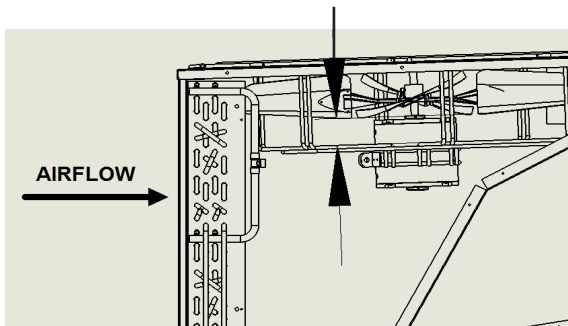

Liquid Line Pressure Transducer

The unit has a pressure transducer installed on the liquid line between the condenser and electronic expansion valve (EEV). The transducer is used for system monitoring of the liquid side system pressures. This information is used to indicate when outdoor coil cleaning is necessary based on outdoor conditions and system pressures. The sensor is also used to adapt the condenser fan speed for high and low ambient conditions. The liquid line transducer is also referred to as the discharge pressure sensor.

The discharge pressure sensor input can be verified and adjusted by:

1. Press MENU key to go to the Main Menu screen.
2. Press UP or DOWN keys and ENTER key to enter TECHNICIAN password 1313.
3. Press UP or DOWN keys to scroll to **I/O Config**; press ENTER key.
4. Press UP or DOWN keys to scroll to **Liquid Pr Sensor C9**.
5. Verify the measurement displayed on screen is accurate (see Figure 37).
6. If the measurement needs to be adjusted, apply an offset value by pressing the ENTER key to scroll to **Offset**.
7. Press UP or DOWN keys to adjust the offset. The update will not take effect until the cursor is moved out of the offset parameter.
8. Once adjusted, press the ESCAPE key several times to return to Main Menu screen.

FIGURE 37
Adjusting Liquid Pressure Transducer Values

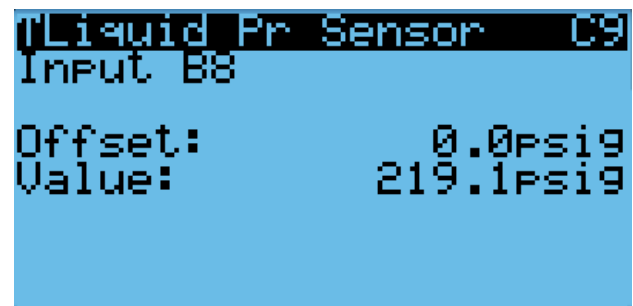

Troubleshooting the Liquid Pressure Transducer

0-650 psig

0-5v

4v/650 psig = .00615 volts per 1 psig

Example: 325 psig x .00615 + .5 v = 2.5 volts

Formula for Tech:

Measured Pressure x .00615 + Sensor Offset = Expected Transducer Signal Voltage (see Figure 38 on page 26).

FIGURE 38
Voltage to Pressure:
Liquid Pressure Transducer

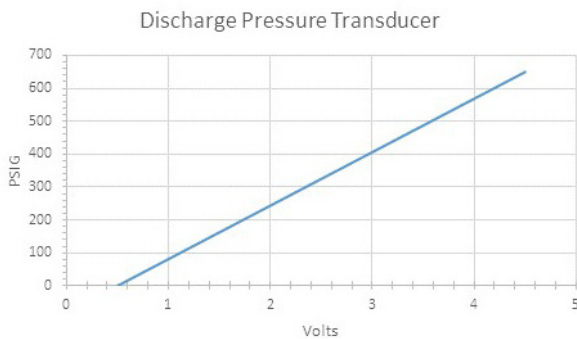

Liquid Pressure Transducer Alarm

When the liquid line pressure sensor value is out of range (0-650 PSIG), the controller will generate a sensor failure alarm to indicate the sensor is not working properly.

This alarm is fixed and cannot be adjusted.

Liquid Temperature Sensor

The unit is equipped with a liquid line temperature sensor to monitor the temperature of the liquid refrigerant leaving the condenser and entering the EEV. The temperature is measured with a 10k ohm NTC thermistor.

The liquid temperature sensor can be verified and adjusted by:

1. Press MENU key to go to the Main Menu screen.
2. Press UP or DOWN keys and ENTER key to enter TECHNICIAN password 1313.
3. Press UP or DOWN keys to scroll to **I/O Config**; press ENTER key.
4. Press UP or DOWN keys to scroll to **Liquid Temp Sensor C2**.
5. Reference the **Value** to verify the temperature (see Figure 39).
6. If an offset needs to be applied, press ENTER key to scroll to **Offset**.
7. Press UP or DOWN keys to change the offset to desired value.
8. Press ENTER key to save.
9. Press ESCAPE key several times to return to Main Menu screen.

FIGURE 39
Adjusting Liquid Temperature Values

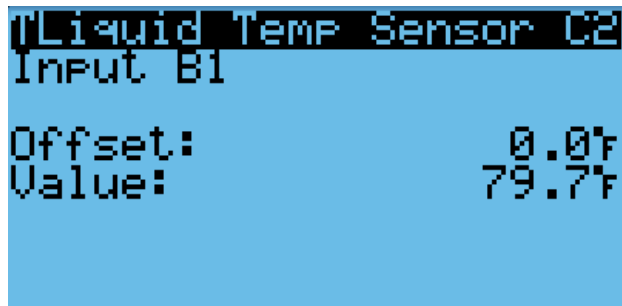

Condenser Fan Operation

Condenser Fan Speed Control

The unit is equipped with a variable speed ECM (electronically commutated motor) condenser fan which allows the unit to better control head pressures for more efficient operation. The fan will speed up or slow down to attempt to maintain a liquid line pressure. The pressure setpoint that the fan will control to is determined by the outdoor air temperature. The unit will allow the liquid line pressure setpoint to increase for high ambient scenarios or decrease for low ambient scenarios. Because the control is dependent on both the outdoor temperature sensor and the liquid line pressure sensor, the controller will alter its operation if a sensor is not enabled or failed. When the outdoor temperature sensor is not enabled or is considered failed by the controller, a nominal setpoint of 430 psi is used for fan control. When the liquid pressure transducer is not enabled or is considered failed by the controller, a nominal fan speed will be used during a compressor cal (see Figure 40).

The condenser fan requires the compressor to be running in order to operate.

High Pressure Control

Condenser Fan Speed

When the liquid pressure reaches 550 PSI, the condenser fan will speed up, moving as much air as possible in an attempt to reduce system pressures. The condenser fan will operate at increased speed until the liquid pressure reaches 450 PSI. At this point, the fan will return to normal operating speed.

Second Stage Drop Out

If the liquid pressure reaches 620 PSI, the second stage of cooling will be disabled for the remainder of the current cooling call. This reduces the risk of tripping the high pressure switch, while still allowing cooling.

Low Ambient Control

At low ambient outdoor air temperatures, the fan motor will cycle as a means of controlling the system's head pressure to protect the system from evaporator coil freeze

FIGURE 40
Liquid Pressure Control Setpoint

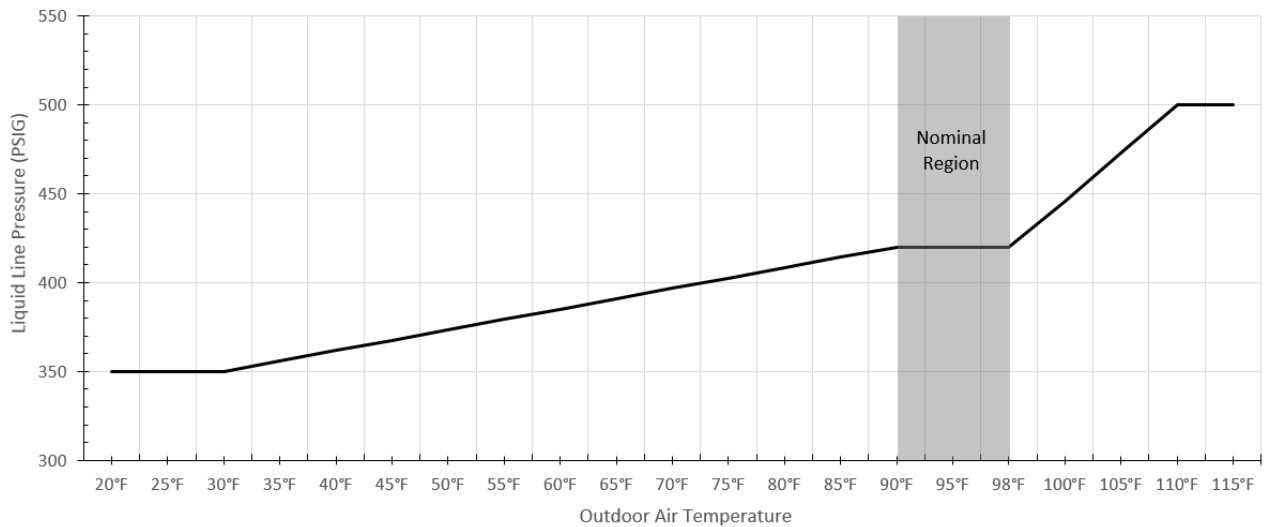

conditions. The process for this system is as follows: If the liquid pressure falls below 275 PSI, the condenser fan will turn off. The fan will remain off while the compressor remains running, allowing the head pressure to build up. Once the liquid pressure reaches 350 PSI, the fan will then turn back on at the appropriate speed. At lower ambient outdoor temperatures, this may cycle regularly as normal operation. In some cases, in higher wind prone areas, the condenser fan may stay off for prolonged durations due to low liquid pressures.

Compressor

Compressor Components

Compressor

Three Phase Scroll Compressor Start Up Information

Scroll compressors, like several other types of compressors, will only compress in one rotational direction. Direction of rotation is not an issue with single phase compressors since they will always start and run in the proper direction.

However, three phase compressors will rotate in either direction depending upon phasing of the power. Since there is a 50-50 chance of connecting power in such a way as to cause rotation in the reverse direction, verification of proper rotation must be made. Verification of proper rotation direction is made by observing that suction pressure drops and discharge pressure rises when the compressor is energized. Reverse rotation also results in an elevated sound level over that with correct rotation, as well as substantially reduced current draw compared to tabulated values.

Verification of **proper rotation** must be made at the time the equipment is put into service. If improper rotation is corrected at this time, there will be no negative impact on the durability of the compressor. However,

reverse operation for over 1 hour may have a negative impact on the bearing due to oil pump out.

NOTE: *If compressor is allowed to run in reverse rotation for an extended period of time, the compressor's internal protector will trip.*

All three phase compressors are wired identically internally. As a result, once the correct phasing is determined for a specific system or installation, connecting properly phased power leads to the same Fusite terminal should maintain proper rotation direction.

The direction of rotation of the compressor may be changed by reversing any two line connections to the wall-mount unit.

Compressor Control Module (CCM)

The compressor control module (CCM) is standard on all models covered by this manual.

Delay-on-Make Timer
Short Cycle Protection/Delay-on-Break
High Pressure Detection
Test Mode
Brownout Protection with Adjustment

The LPC terminals are jumpered in this application. Instead, the low pressure transducer is used for low pressure monitoring.

Delay-on-Make Timer

In the event of power loss, a delay-on-make timer is included to be able to delay startup of the compressor. This is desired when more than one unit is on a structure so that all of the units do not start at the same time which could happen after a power loss or building shutdown. The delay-on-make time period is 2 minutes plus 10% of the delay-on-break time period. To ensure that all of the units do not start at the same

time, adjust the delay-on-break timer on each unit to a slightly different delay time.

Short Cycle Protection/Delay-on-Break

An anti-short cycle timer is included to prevent short cycling the compressor. This is adjustable from 30 seconds to 5 minutes via the adjustment knob (see Figure 41). Once a compressor call is lost, the time period must expire before a new call will be initiated.

10% of this time is also considered on the delay-on-make timer (see **Delay-on-Make Timer**).

High Pressure Detection

High pressure switch monitoring allows for a lockout condition in a situation where the switch is open. If the high pressure switch opens, the CCM will de-energize the compressor. If the switch closes, it will then restart the compressor after the delay-on-break setting has expired on the device. If the switch trips again during the same Y call, the compressor will be de-energized. The ALR terminal will be energized signaling the unit control board that a high pressure event has occurred (see **Refrigerant High Pressure Alarm** on page 29).

Test Mode

By rapidly rotating the potentiometer (POT) clockwise (see Figure 41), all timing functions will be removed for testing.

The conditions needed for the unit to enter test mode are as follows: POT must start at a time less than or equal to the 40 second mark. The POT must then be rapidly rotated to a position greater than or equal to the 280 second mark in less than ¼ second. Normal operation will resume after power on reset or after the unit has been in test mode for at least 5 minutes.

Brownout Protection with Adjustment

Brownout protection may be necessary if the utility power or generator power has inadequate power to prevent the voltage from dropping when the compressor starts. This is rare but can happen if the generator is undersized at the site or if the site is in a remote location far from the main power grid. Under normal circumstances, allowing the brownout to be ignored for a time period should not be needed. The 8201-169 is shipped with all the DIP switches in the 'off' or 'do not ignore' position (see Figure 41).

FIGURE 41
8201-169 Compressor Control Module

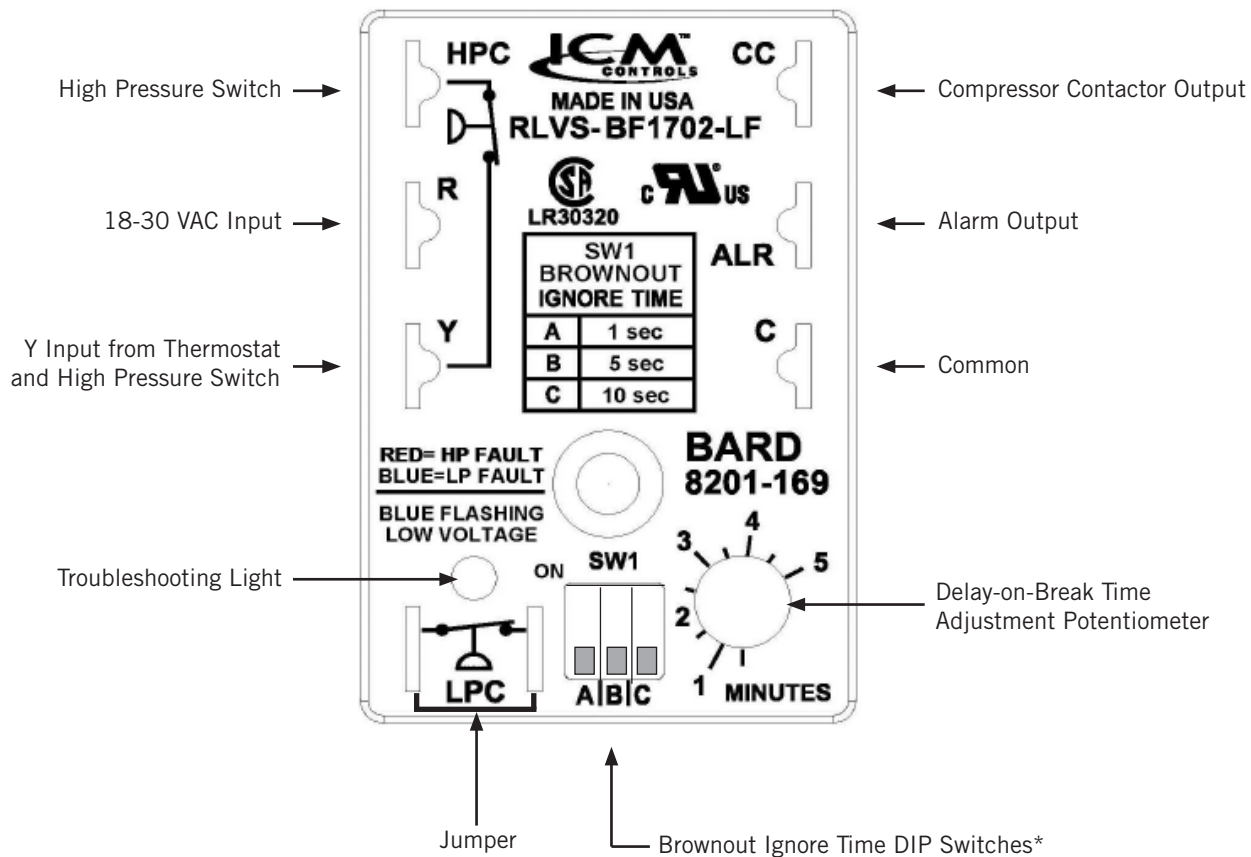

* Turn on only one switch for that specific ignore time setting. 10 seconds is the maximum brownout ignore time. If all switches are "off", the control is in "do not ignore".

If ignoring the brownout is needed because of the above conditions, three preset timers can be set by DIP switches in order to delay signaling a power brownout for a specific length of time after compressor contactor is energized. This allows the compressor a time period to start even if the voltage has dropped and allows the voltage to recover. This delay only happens when the CC terminal energizes. The delay can be set to 1 second (A DIP switch), 5 seconds (B DIP switch) or 10 seconds (C DIP switch); time is not cumulative—only the longest setting will apply. If the voltage recovers during the brownout delay period, the compressor will start.

If a brownout condition is detected by the 8201-169, the troubleshooting light will flash blue. The light will continue to flash until the cooling call is satisfied or power is removed from the Y terminal. This condition does not prevent operation, it only indicates that a brownout condition was present at some point during the cooling call. If a brownout condition is detected, CC will be de-energized and will retry after the delay-on-make timer is satisfied; this process will continue until call is satisfied.

If user chooses the "do not ignore" position (all three DIP switches "off") when the site has inadequate utility or generator power, this could lead to the compressor never starting. The control will see the brownout immediately and not start.

A common scenario and one that has been seen in the field is when a unit or units switches from utility power to generator power. With slower transfer switches, the time delay between the utility power and generator power didn't cause a problem. The units lost power, shut off and came back on line normally. With the introduction of almost instantaneous transfer switches, the millisecond long power glitch can be enough that the compressor will start to run backwards. In this scenario, the CCM will catch this and restart the units normally.

High Pressure Safety Switch

All units have a high pressure switch as a safety device. This device will open when pressure in the system reaches 650 PSIG. The sensor is directly connected to the dedicated compressor control module (see **High Pressure Detection** on page 28).

Refrigerant High Pressure Alarm

When the wall-mount unit receives a signal from the compressor control module (CCM) indicating a high pressure event, the wall-mount unit will generate an alarm. Upon receiving the alarm, the wall-mount unit will remove the "Y" call from the CCM, resetting the status of the CCM. The alarm will stay present on the wall-mount unit until manually cleared with TEC-EYE hand-held diagnostic tool.

In addition to the CCM, the discharge pressure transducer is used to prevent a high pressure event. When the discharge pressure is above the discharge pressure alarm setpoint (set 30 PSI below high

pressure switch, which is 650 PSI), the system will disable stage 2 of mechanical cooling.

Phase Monitor

Used only on three phase equipment, the phase monitor is a compressor protection device that will prohibit operation of the compressor if the device senses a possible reverse-rotation situation due to incorrect phasing. On a call for compressor (and only compressor), the device will check incoming phase, check for severe voltage imbalance and check for proper frequency. Under nominal conditions, a green LED light will show on the face of the monitor. If there is improper phasing, voltage imbalance or frequency deviation, the device will show a red LED light and prohibit compressor operation.

If a fault condition occurs, reverse two of the supply leads to the unit. **Do not reverse any of the unit factory wires as damage may occur.**

Compressor Operation

The compressor will be enabled when the unit (in orphan mode) or LC provide a cooling stage 1 call. The compressor call from the controller has several delays that may affect the start or stop time of the compressor in regards to the cooling demand. The compressor has a minimum on time of 120 seconds to prevent short cycling the compressor. The compressor also has a minimum off time of 120 seconds to prevent start ups before the pressure in the refrigeration system equalizes. When the second stage is engaged, it also has a minimum run time of 120 seconds to allow the system to stabilize before returning to single stage or shutting down.

These delays can be changed by:

1. Press MENU key to go to the Main Menu screen.
2. Press UP or DOWN keys and ENTER key to enter TECHNICIAN password 1313.
3. Press UP or DOWN keys to scroll to **Adv System Config**; press ENTER key.
4. Press UP or DOWN keys to scroll to **Compressor Config B2**.
5. Press ENTER key to scroll to **Min On** or **Min Off** (see Figure 42).

FIGURE 42
Adjusting Compressor Delays

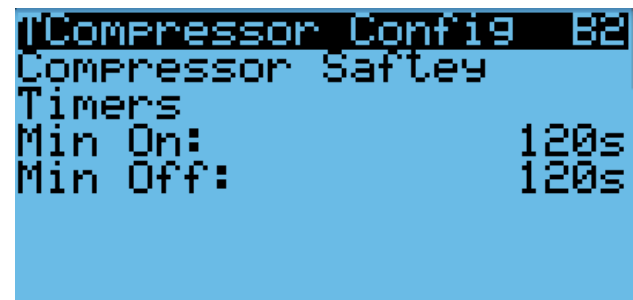

6. Press UP or DOWN keys to change the value.
7. Press ENTER key to save value and move the cursor to next parameter or top of screen.
8. Press ESCAPE key several times to return to Main Menu screen.

The address-based delay only applies to the wall-mount unit when in orphan mode. The controller will delay the unit compressor based on the value entered on screen B2 multiplied by the unit address. This is intended to keep multiple units from starting their compressors at the same time when there is a quick change in the load. When connected to the LC, this is taken care of by LC logic.

Compressor Low Temperature Limit

The unit has the ability to protect the compressor from refrigerant flood-back in low outdoor temperature conditions (0°F default). This will be automatically enabled, unless the economizer is disabled by the model number. This function can also be enabled/disabled, and limit temp changed by the user.

To adjust compressor low temp limit:

1. Press MENU key to go to the Main Menu screen.
2. Press UP or DOWN keys and ENTER key to enter TECHNICIAN password 1313.
3. Press UP or DOWN keys to scroll to **Adv System Config**; press ENTER key.
4. Press UP or DOWN keys to scroll to **Compressor Config B3**.
5. Press ENTER key to scroll to **Comp. Limit** (see Figure 43).
6. Press UP or DOWN keys to change **ON** or **OFF** value.
7. Press ENTER key to save value and move the cursor to **Cutoff Temp**.
8. Press UP or DOWN keys to adjust temperature.
9. Press ENTER key to save value.
10. Press ESCAPE key several times to return to Main Menu screen.

FIGURE 43
Adjusting Compressor Low Temp Limit

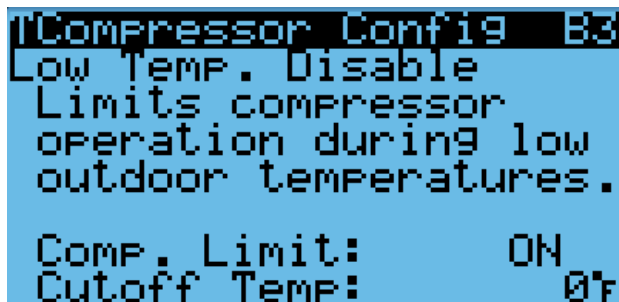

Additional Compressor Alarm

Refrigerant Low Pressure Alarm

When the suction pressure transducer indicates a pressure value below the low pressure alarm setpoint of 40 PSI and the compressor has been running for more than 180 seconds, or the suction pressure is pulled into a vacuum for more than 20 seconds, the controller will disable the compressor. **NOTE: The second call will be delayed based on the delay off value mentioned in the compressor section.** The controller will try to run the refrigeration system two (2) times within 3600 seconds (1 hour) before the alarm will lock the compressor out. This alarm needs to be manually cleared before compressor operation will resume.

To adjust the low pressure alarm settings:

1. Press MENU key to go to the Main Menu screen.
2. Press UP or DOWN keys and ENTER key to enter USER password 2000.
3. Press UP or DOWN keys to scroll to **System Config**; press ENTER key.
4. Press UP or DOWN keys to scroll to **Alarm Setup A6**.
5. Press ENTER key to scroll to **Delay** to adjust how long the compressor waits before turning the compressor off (see Figure 44).
6. Press UP or DOWN keys to adjust the time delay.
7. Press ENTER key to scroll to **Two Count Delay**.
8. Press UP or DOWN keys to adjust the delay value.
9. Press ENTER key to save.
10. Press the ESCAPE key several times to return to Main Menu screen.

FIGURE 44
Adjusting Low Pressure Alarm Settings

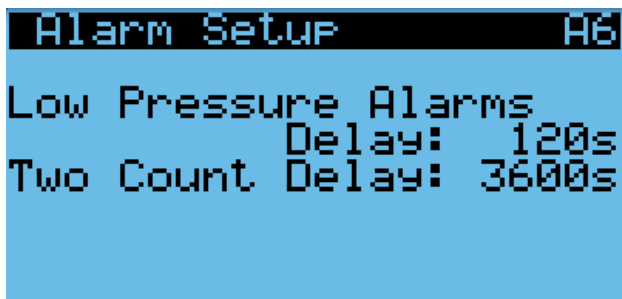

Economizer

Economizer Components

Actuator

The actuator rotates up to 90° based on a 2-10v signal sent to it by the controller. The actuator is rated at 90 in-lb and is spring return when power is lost. This component is what opens and closes the damper blade.

To verify the output from the controller to the actuator:

1. Press MENU key to go to the Main Menu screen.
2. Press UP or DOWN keys and ENTER key to enter TECHNICIAN password 1313.
3. Press UP or DOWN keys to scroll to **I/O Config**; press ENTER key.
4. Press UP or DOWN keys to scroll to **Damper Output C13**.
5. Reference the **Damper Position** for the current output to the damper (see Figure 45).
6. To override the current position, press ENTER key to scroll to **OV Pos**.
7. Press UP or DOWN keys to change the value to the desired output.
8. Press ENTER key to save the value and move cursor to **Damper Override**.
9. Press UP or DOWN keys to change the value from **OFF** to **ON**.
10. The **Damper Position** will update with the new override value and the damper will travel to that position.

The override will last for 5 minutes or until the **Damper Override** parameter is set to OFF again.

NOTE: *If unit is operating at the time the damper override is being enabled, adjustments must be made to **OV Speed** first before switching Damper Override on.*

FIGURE 45
Damper Output and Override

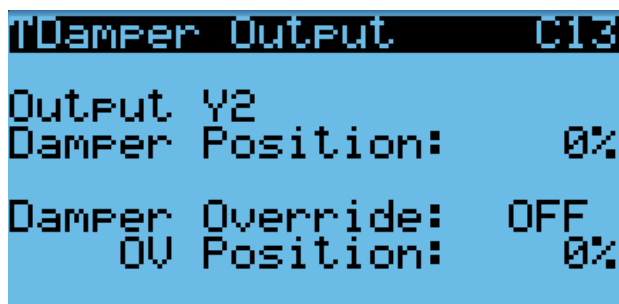

Dust Sensor

The unit has a dust sensor installed near the outdoor air inlet. The dust sensor checks for excessive particulates in the outdoor air, and will close the economizer if the dust is excessive. The sensor uses a PWM signal converted to 0-5v output to the controller. This sensor is disabled by default and will need to be enabled for the dust alarm to function.

To ensure proper performance, cleaning may be required. Vacuuming or blowing the dust off the sensor with forced air is recommended. **Avoid inserting any objects into the sensor.**

The dust sensor can be verified by:

1. Press MENU key to go to the Main Menu screen.
 2. Press UP or DOWN keys and ENTER key to enter TECHNICIAN password 1313.
 3. Press UP or DOWN keys to scroll to **I/O Config**; press ENTER key.
 4. Press UP or DOWN keys to scroll to **Dust Sensor C7**.
 5. Reference the **Value** for the current sensor reading (see Figure 46).
 6. To apply an offset to the current reading, press ENTER key to scroll to **Offset**.
 7. Press UP or DOWN keys to adjust the value to the desired value.
 8. Press ENTER key to save the value and move cursor back to top of screen.
- NOTE:** *The sensor can be disabled if required for troubleshooting.*
9. Press ENTER key to scroll to **Enable** parameter.
 10. Press UP or DOWN keys to change the value from **ON** to **OFF**.
 11. Press ENTER key to save.

FIGURE 46
Dust Sensor

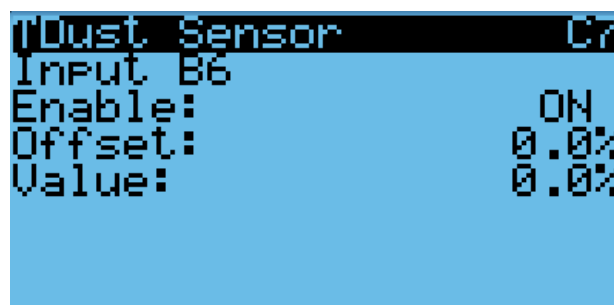

Dust Sensor Failure Alarm

When the sensor reads a value that is outside of the acceptable 0 to 100% range, an alarm will be generated indicating the sensor has failed. This alarm is just a notification and will not disable any other features on the controller.

This alarm is fixed and cannot be adjusted.

High Dust Limit Alarm

When dust content in the air is high and is a risk to prematurely reducing airflow through the filters, the unit will restrict the use of the economizer. The controller has adjustable software setpoints (default to 80%) to indicate dust levels are too high and to disable the economizer operation for 5 minutes (unit default). This alarm is not communicated to the NOC. Once the conditions are no longer present, the alarm will automatically clear.

Disabling the dust sensor in **I/O Config** disables this alarm.

To adjust the dust sensor alarm setpoint:

1. Press MENU key to go to the Main Menu screen.
2. Press UP or DOWN keys and ENTER key to enter USER password 2000.
3. Press UP or DOWN keys to scroll to **System Config**; press ENTER key.
4. Press UP or DOWN keys to scroll to **Alarm Setup A9**.
5. Press ENTER key to scroll to **Setpoint** (see Figure 47).
6. Press UP or DOWN keys to change to the desired value.
7. Press ENTER key to save the value.

NOTE: When the temperature outside is measured at or below 0°F, the dust sensor alarm will be disabled to allow economizer operation. This is done because the compressor is disabled below 0°F and the system would not have the capability to cool.

FIGURE 47
Adjusting Dust Sensor Alarm Setpoint

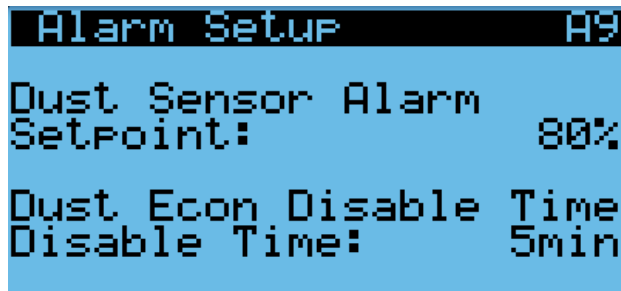

Damper Blade

The system utilizes three damper blades used to bring in outdoor air and exhaust space air for economizer operation. The damper blades are made of sheet metal and are integrated into the equipment.

Minimum Damper Position

This unit has a minimum damper position feature to vent the space and intake fresh air whenever the blower is operating. This feature operates separately from free cooling operation and minimum position should not be set to a higher position than needed, as it is not controlled by room or outdoor conditions. This feature is disabled by default, but is available if needed.

To enable/disable/adjust the minimum damper position:

1. Press MENU key to go to the Main Menu screen.
2. Press UP or DOWN keys and ENTER key to enter TECHNICIAN password 1313.

3. Press UP or DOWN keys to scroll to **System Config**; press ENTER key.
4. Press UP or DOWN keys to scroll to **Economizer Setup A3**.
5. Press ENTER key to scroll to **Minimum Position Enable** (see Figure 48).
6. Press UP or DOWN keys to change **ON** or **OFF** value.
7. Press ENTER key to save value and move the cursor to **Position**.
8. Press UP or DOWN keys to adjust the minimum position value.
9. Press ENTER key to save value.
10. Press ESCAPE key several times to return to Main Menu screen.

FIGURE 48
Adjusting Minimum Damper Position

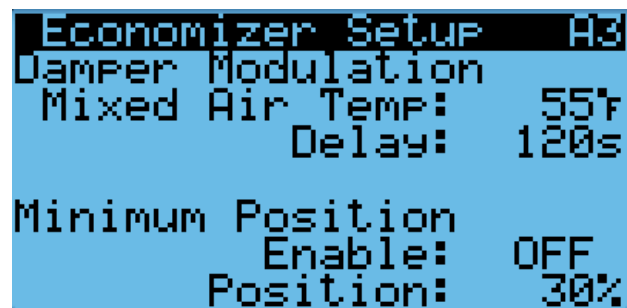

Damper Switch

The economizer utilizes a magnetic switch to determine if the damper is operating correctly. This switch will be closed when the damper is closed and open when the damper is open.

To verify the status of the switch:

1. Press MENU key to go to the Main Menu screen.
2. Press UP or DOWN keys and ENTER key to enter TECHNICIAN password 1313.
3. Press UP or DOWN keys to scroll to **I/O Config**; press ENTER key.
4. Press UP or DOWN keys to scroll to **Digital In Config C1**.
5. Reference the value located at **Damper** row and **Val** column (see Figure 49).
6. The input will display **ON** when the damper is closed (reflecting closed circuit on damper switch) and will display **OFF** when the damper is open (reflecting open circuit on damper switch).

FIGURE 49
Damper Switch

Digital In Config C1			
Channel	En	Dir	Val
Disable	OFF	N/O	OFF
Filter	ON	N/O	OFF
CCM	ON	N/O	OFF
PwrLoss	ON	N/C	OFF
Damper	ON	N/C	OFF
Airflow	ON	N/O	ON

Damper Failed to Open Alarm

When the controller commands the economizer damper actuator to a position other than 0% and the damper switch indicates the damper is not open, after a delay of 20 seconds the controller will generate a damper failed to open alarm. This alarm is just a notification and will not disable any features on the controller.

Disabling the damper switch in **I/O Config** disables this alarm.

To adjust the damper failed to open delay:

1. Press MENU key to go to the Main Menu screen.
2. Press UP or DOWN keys and ENTER key to enter USER password 2000.
3. Press UP or DOWN keys to scroll to **System Config**; press ENTER key.
4. Press UP or DOWN keys to scroll to **Alarm Setup A4**.
5. Press ENTER key to scroll to **Open Delay** (see Figure 50).
6. Press UP or DOWN keys to change to the desired value.
7. Press ENTER key to save the value.

FIGURE 50
Adjusting Damper Alarm Delay

Alarm Setup A4	
Damper Alarms	
Open Delay:	60s
Close Delay:	300s

Damper Failed to Close Alarm

When the controller commands the economizer damper actuator to the 0% position and the damper switch indicates the damper is not closed, after a delay of 300 seconds the controller will generate a damper failed to close alarm. This alarm will disable all functions of the unit and the status message will display "Off by Alarm". If the condition is remedied, the alarm will automatically reset and the unit will resume normal operation.

Disabling the damper switch in **I/O Config** disables this alarm.

To adjust the damper failed to close delay:

1. Press MENU key to go to the Main Menu screen.
2. Press UP or DOWN keys and ENTER key to enter USER password 2000.
3. Press UP or DOWN keys to scroll to **System Config**; press ENTER key.
4. Press UP or DOWN keys to scroll to **Alarm Setup A4**.
5. Press ENTER key to scroll to **Close Delay** (see Figure 50).
6. Press UP or DOWN keys to change to the desired value.
7. Press ENTER key to save the value.

Outdoor Temperature and Humidity Combination Sensor

The unit is equipped with a combination outdoor temperature and humidity sensor to monitor outdoor conditions for the economizer operation. The temperature is measured with a 10k ohm NTC thermistor. The humidity is measured with a humidity sensor that outputs a 4-20mA signal to the controller. Troubleshooting information for this sensor is included in the Troubleshooting section of this manual.

The outdoor temperature can be verified by:

1. Press MENU key to go to the Main Menu screen.
2. Press UP or DOWN keys and ENTER key to enter TECHNICIAN password 1313.
3. Press UP or DOWN keys to scroll to **I/O Config**; press ENTER key.
4. Press UP or DOWN keys to scroll to **Outdoor Air Sensor C3**.
5. Reference the **Value** to see the input of the sensor (see Figure 51 on page 34).
6. To apply an offset, press ENTER key to scroll to **Offset**.
7. Press UP or DOWN keys to change to the desired value.
8. Press ENTER key to save the value.

FIGURE 51
Outdoor Air Sensor

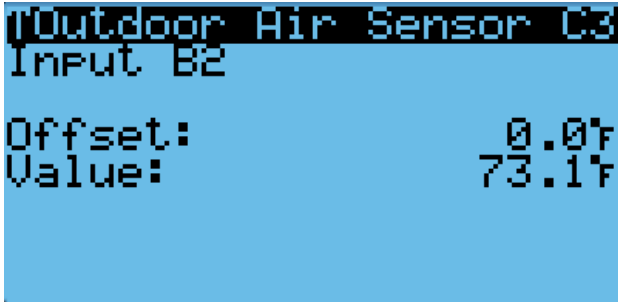

The outdoor humidity can be verified by:

1. Press MENU key to go to the Main Menu screen.
2. Press UP or DOWN keys and ENTER key to enter TECHNICIAN password 1313.
3. Press UP or DOWN keys to scroll to **I/O Config**; press ENTER key.
4. Press UP or DOWN keys to scroll to **Outdoor Hum Sensor C6**.
5. Reference the **Value** to see the input of the sensor (see Figure 52).
6. To apply an offset, press ENTER key to scroll to **Offset**.
7. Press UP or DOWN keys to change to the desired value.
8. Press ENTER key to save the value.

FIGURE 52
Outdoor Humidity Sensor

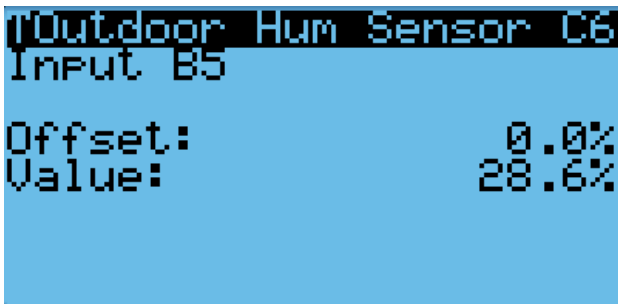

Outdoor Temperature Sensor Failure Alarm

When the sensor reads a value that is outside of the acceptable -41 to 303.0° range, an alarm will be generated indicating the sensor has failed. This alarm condition will disable the economizer.

This alarm is fixed and cannot be adjusted.

Outdoor Humidity Sensor Failure Alarm

When the sensor reads a value that is outside of the acceptable 0 to 100% RH range, an alarm will be generated indicating the sensor has failed. This alarm condition will disable the economizer when the mode is set to temperature and humidity or enthalpy.

This alarm is fixed and cannot be adjusted.

Supply Temperature Sensor

The unit is equipped with a supply air temperature sensor to monitor the leaving air temperature of the unit. The temperature is measured with a 10k ohm NTC thermistor.

The supply air temperature can be verified by:

1. Press MENU key to go to the Main Menu screen.
2. Press UP or DOWN keys and ENTER key to enter TECHNICIAN password 1313.
3. Press UP or DOWN keys to scroll to **I/O Config**; press ENTER key.
4. Press UP or DOWN keys to scroll to **Supply Air Sensor C5**.
5. Reference the **Value** to see the input of the sensor (see Figure 53).
6. To apply an offset, press ENTER key to scroll to **Offset**.
7. Press UP or DOWN keys to change to the desired value.
8. Press ENTER key to save the value.

FIGURE 53
Supply Air Sensor

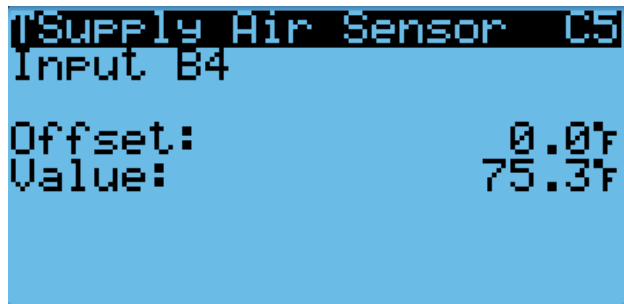

Supply Temperature Sensor Failure Alarm

When the sensor reads a value that is outside of the acceptable -41.0 to 303.0° range, an alarm will be generated indicating the sensor has failed.

This alarm is fixed and cannot be adjusted.

High Supply Air Temperature Alarm

When the supply air temperature is above 80°F for 120 seconds, an alarm will be generated and the economizer will be disabled until the cooling call has been removed. This alarm can only be activated during free cooling and will automatically reset once the economizer is no longer disabled.

To change the high supply air temperature alarm:

1. Press MENU key to go to the Main Menu screen.
2. Press UP or DOWN keys and ENTER key to enter USER password 2000.
3. Press UP or DOWN keys to scroll to **System Config**; press ENTER key.
4. Press UP or DOWN keys to scroll to **Alarm Setup A5**.
5. Press ENTER key to scroll to **Hi and Diff** value (see Figure 54).
6. Press UP or DOWN keys to change the differential to the desired value.
7. Press ENTER key to save the value.

FIGURE 54
Adjusting Supply Air Temperature Differential

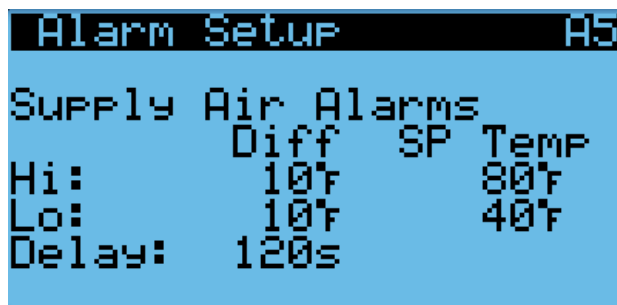

Low Supply Air Temperature Alarm

When the supply air temperature is below 45°F for 120 seconds, an alarm will be generated and the economizer will be disabled until the cooling call has been removed. This alarm can only be activated during free cooling and will automatically reset once the economizer is no longer disabled..

To change the low supply air temperature alarm:

1. Press MENU key to go to the Main Menu screen.
2. Press UP or DOWN keys and ENTER key to enter USER password 2000.
3. Press UP or DOWN keys to scroll to **System Config**; press ENTER key.
4. Press UP or DOWN keys to scroll to **Alarm Setup A5**.
5. Press ENTER key to scroll to **Lo and Diff** value (see Figure 54).
6. Press UP or DOWN keys to change the differential to the desired value.

7. Press ENTER key to save value and scroll to **Delay**.
8. Press UP or DOWN keys to adjust the delay value.

NOTE: This delay is also applied to the high supply air temperature alarm.

9. Press ENTER key to save.

Economizer Operation

The economizer has four types of operation. The first mode is "None" where the economizer is never utilized, except for emergency purposes. The second mode is "Dry Bulb" where the outdoor temperature is the only consideration for economizer use on a free cooling call. The third mode is "TempHum" where the outdoor temperature and humidity are considered for economizer use on a free cooling call. The fourth mode is "Enthalpy" where the outdoor temperature, humidity and calculated dew point are considered for economizer operation on a free cooling call.

To change the economizer type and setpoints:

1. Press MENU key to go to the Main Menu screen.
2. Press UP or DOWN keys and ENTER key to enter USER password 2000.
3. Press UP or DOWN keys to scroll to **System Config**; press ENTER key.
4. Press UP or DOWN keys to scroll to **Economizer 1/2 A2**.
5. Press ENTER key to scroll to **Control Type** (see Figure 55).

FIGURE 55
Economizer 1/2

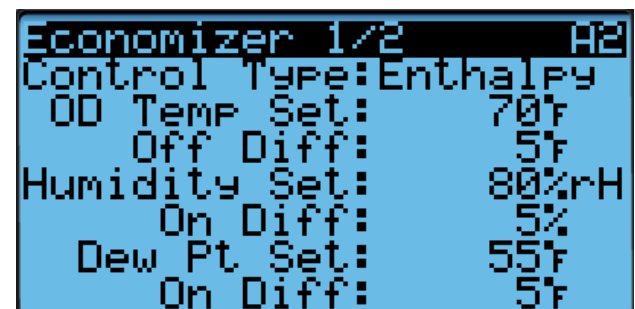

6. Press UP or DOWN keys to change the **Type** desired value to **None**, **Dry Bulb**, **TempHum** or **Enthalpy**.
7. Press ENTER key to save the value and scroll to the next parameter.

NOTE: Some of the following parameters may not be present until the control type that it is used with is selected.

8. If control type is other than **None**, the cursor should now be on the **OD Temp Set** parameter.

9. Press UP or DOWN keys to change the parameter to the desired value.
10. Press ENTER key to save the value and scroll to the next parameter.
11. Press UP or DOWN keys to change the (outdoor temperature) **Off Diff** parameter to the desired value.
12. Press ENTER key to save the value and move to the next parameter.
13. If control type is **TempHum** or **Enthalpy**, the cursor should now be on **Humidity Set** parameter.
14. Press UP or DOWN keys to change the parameter to the desired value.
16. Press UP or DOWN keys to change the (outdoor humidity) **On Diff** parameter to the desired value.
17. Press ENTER key to save the value and move to the next parameter.
18. If control type is **Enthalpy**, the cursor should now be on **Dew Pt Set** parameter.
19. Press UP or DOWN keys to change the parameter to the desired value.
20. Press ENTER key to save the value and move to the next parameter.
21. Press UP or DOWN keys to change the (outdoor dew point) **On Diff** parameter to the desired value.
22. Press ENTER key to save the value.

To change economizer settings:

1. Press MENU key to go to the Main Menu screen.
2. Press UP or DOWN keys and ENTER key to enter USER password 2000.
3. Press UP or DOWN keys to scroll to **System Config**; press ENTER key.
4. Press UP or DOWN keys to scroll to **Economizer 2/2 A3**.
5. Press ENTER key to scroll to **Supply Temp** (see Figure 56).

FIGURE 56
Economizer 2/2

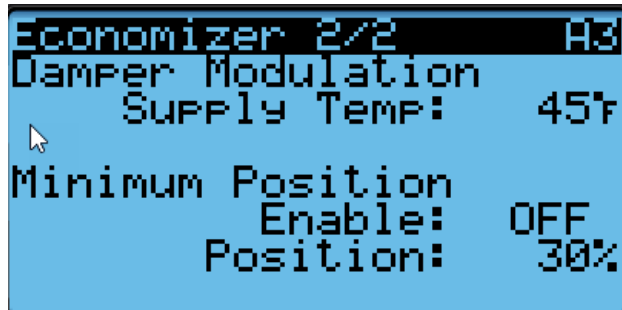

6. Press UP or DOWN keys to change the parameter to the desired value.
7. Press ENTER key to save the value.
8. Press ESCAPE key several times to return to Main Menu screen.

See Table 10 for default settings for economizer operation.

When the economizer is activated during a free cooling call only, using any of the previously mentioned modes, a 0-10v analog signal will be sent to the economizer actuator. The actuator will then open and close the damper blades to maintain a supply air temperature of 45°F. If the economizer is active during optimized cooling mode, the actuator will maintain a supply air temperature of 45°F. When the supply air temperature increases, the damper will open and when the supply air temperature decreases, the damper will close.

The economizer may be disabled by the LC if the system determines it needs to enter dehumidification mode. More information about the dehumidification sequence can be found on page 16 and in the latest revision of LC6000 Service Instructions 2100-669. In addition to dehum mode, the economizer may be disabled for 5 minutes (adjustable) if the dust sensor indicates the outdoor air may cause particulate buildup in the air filters. After the time has expired and on a call for cooling, the economizer will open again to sample

TABLE 10
Economizer Default Settings

Mode		Consideration	Economizer Available for Cooling	Economizer Not Available for Cooling	
Temp Only	Temp & Humidity	Enthalpy*	Temperature	When the outdoor air temperature is below 70°F	When the outdoor air temperature is above 75°F
			Humidity	LC Online: When the outdoor humidity is below 80%	LC Online: When the outdoor humidity is above 80%
				LC Offline: When the outdoor humidity is below 60%	LC Offline: When the outdoor humidity is above 60%
		Dew Point	When the outdoor dew point is below 55°F	When the outdoor dew point is above 60°F	

* In Enthalpy mode, outdoor temperature, humidity and calculated dew point are all considered for economizer operation.

the air. The wall-mount unit will either return to normal operation or remain locked out for another 5 minutes.

Emergency Cooling Mode

If the shelter temperature is above the high temperature alarm setpoint on the LC, the unit will be commanded into emergency cooling mode. In this mode, the unit will operate the economizer regardless of the economizer setup, as long as the outdoor temperature is below the indoor temperature. The cooling demand will be automatically set to 100% in this mode, meaning mechanical cooling should be operating at full capacity while this mode is active. This will stay active until the LC returns the unit to normal operation. This mode is only available when connected to the LC.

Emergency Ventilation Mode

If a hydrogen detector is connected to the LC/WR Series system and there is a hydrogen alarm event, the system will go into emergency ventilation mode. In emergency ventilation mode, the economizers on the wall units will be commanded to 100%. After 2 minutes, the blowers will turn on in order to exhaust any hydrogen gas buildup within the shelter. Once the hydrogen alarm clears, the system will resume normal operation. This mode is only available when connected to the LC.

Model/Serial Number Configuration

FUSION-TEC WR Series wall-mount units configure some settings based on the model number that is input into the unit. The model and serial number are entered at the factory, and should be retained during a software update. However, after a software update, it is best practice to verify that the model and serial number is still present and accurate. If the model and/or serial number is missing or incorrect they will need to be re-entered.

NOTE: When re-entering the model number, only valid model number entries will be accepted by the PLC.

To update model/serial numbers:

1. Press MENU key to go to the Main Menu screen.
2. Press UP or DOWN keys and ENTER key to enter ENGINEER password 9254.
3. Press UP or DOWN keys to scroll to **Adv Sys Config**; press ENTER key.
4. Press UP or DOWN keys to scroll to **Model/Serial Set B1**.
5. Press ENTER key to advance the cursor to the digit that needs changed in the model/serial number.
6. Press UP or DOWN keys to change value of the digit.

NOTE: The characters are in ASCII format and some digits may not have a character assigned to them. This will required pressing the UP or DOWN key until these characters are passed.

7. Continue Steps 5 and 6 until the model/serial number(s) are correct and reflect the number on the product label.

For more information on the options and settings available for specific model numbers, please see the model number breakdown in Figure 58 on page 41.

Electric Heat Option

Electric Heat Components

Electric Heating Element

The unit is optionally equipped with a 1.5kw or 5kw heat strip. The heat strip is located next to the blower assembly and uses resistive heat.

Thermal Overload

The heater assembly has a thermal overload wired in series with the heating element. This device has a cycling limit which opens at 130°F and resets at 80°F. The limit is also equipped with a redundant thermal fuse that will open at 150°F.

Electric Heat Operation

The heat strip will be activated on a call for heat. This call can be generated by the LC or the wall-mount unit operating in orphan mode.

Bard Guard Anti-Theft System Option

The unit has the option to be shipped from the factory with a low pressure switch, panel sensors and a speaker. These devices are used with the Bard Guard BG1000 anti-theft controller to provide an anti-theft measure. These sensors and switch form a loop that when connected to the BG1000 controller will cause the system to go into alarm if any of the front panels or coil assemblies are removed without being disarmed. The speaker provides an audible alert that the system is being tampered with. The Bard Guard anti-theft control sensor connection is wired to terminals 7 and 8 on the wall-mount unit. The speaker connection is wired to terminals 5 and 6 on the wall-mount unit. See the latest revision of BG1000 Installation Instructions 2100-672 for directions on connecting the wall-mount units to the BG1000 controller.

Unit Disable Option

The unit is equipped with an input that can be used with a smoke detector or unit disable switch with a dry contact. When this input indicates a smoke event, the system will be shut down. The alarm will automatically clear when the alarm condition is no longer present.

Inverter Option

The inverter is only used in applications where a generator is not present and the wall-mount units must run during a power loss event. The inverter will always keep power available to the wall-mount units during a power outage. In the event of a power outage, a power loss relay in the wall-mount unit will be energized and will only allow

the blower and economizer to run while powering the controller. The inverter converts either 24 VDC or 48 VDC, depending on the model, to 230 VAC. A relay output from the inverter will also communicate an alarm to the supervisory controller in the event of an inverter failure. This variable can be communicated through the Ethernet port for integration into a building management system. The units will continue to run in economizer-only operation until power has been restored or the battery power has been depleted.

When the wall-mount unit is operating under inverter power, shelter economizer cooling will only occur if outside temperatures fall below indoor temperatures and blower speeds are slightly reduced to conserve battery power.

FIGURE 57
FUSION-TEC WR Series Wall-Mount Unit Control Board 8301-068-004*

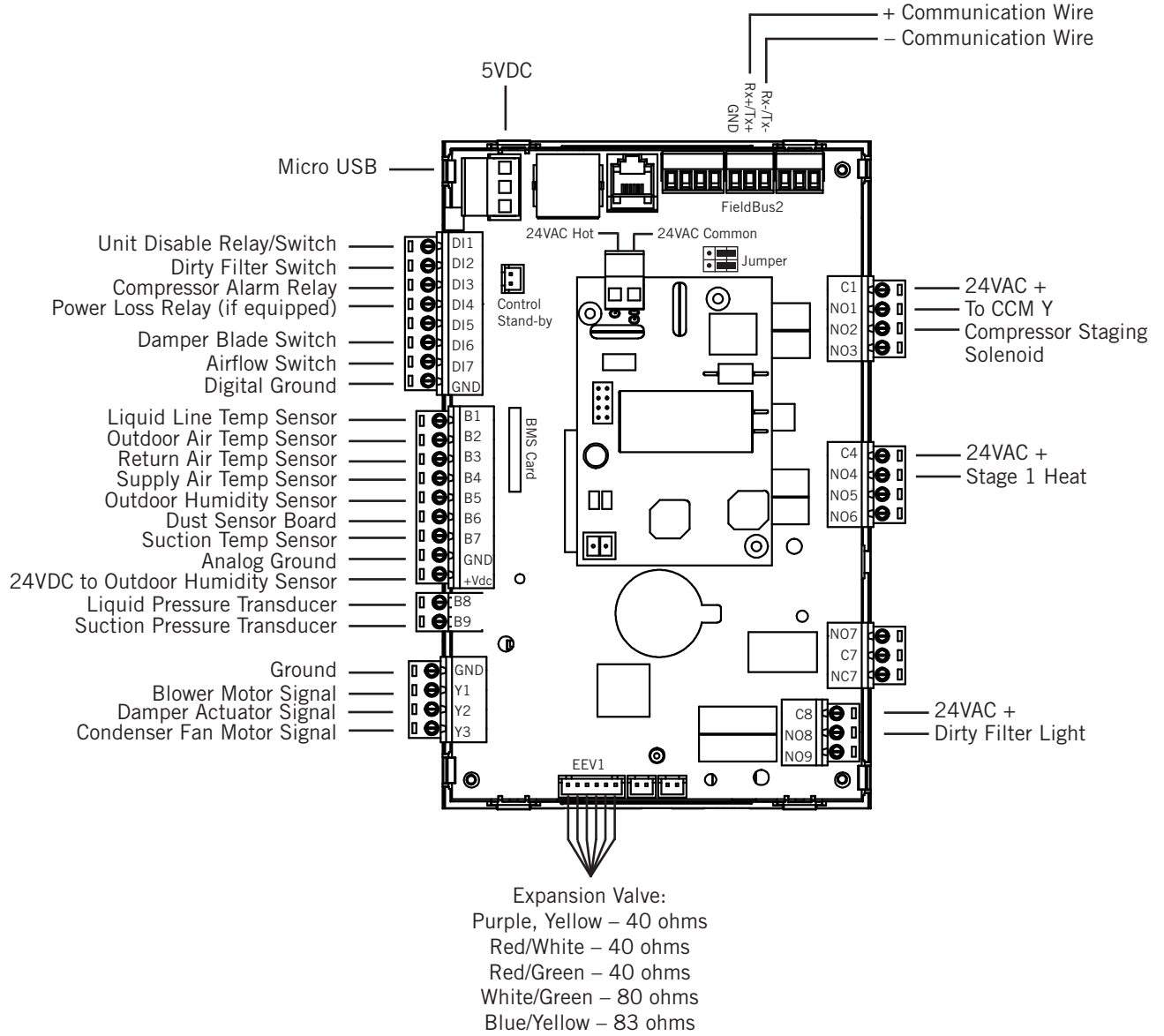

* Asterisk represents letter at end of part number that designates software version (Example: 8301-068-004**A**).

See Table 11 on page 40 for information on control board terminal functions.

TABLE 11
FUSION-TEC WR Series Wall-Mount Unit Control Board Terminals

Terminal	Function	Type	Form
Rx+/Tx+	Communication		
Rx-/Tx-	Communication		
DI1	Unit Disable Relay/Switch	Digital Input	N/C
DI2	Dirty Filter Switch	Digital Input	N/C
DI3	Compressor Alarm Relay	Digital Input	N/C
DI4	Power Loss Relay (if used)	Digital Input	N/C
DI5	Not Used		
DI6	Damper Blade Switch	Digital Input	N/C
DI7	Airflow	Digital Input	N/C
GND	Digital Ground		
B1	Liquid Line Temperature Sensor	Analog Input	10K Ohm Curve J
B2	Outdoor Air Temperature Sensor	Analog Input	10K Ohm Type III (AN)
B3	Return Air Temperature Sensor	Analog Input	10K Ohm Curve J
B4	Supply Air Temperature Sensor	Analog Input	10K NTC Thermistor
B5	Outdoor Humidity Sensor	Analog Input	4mA to 20mA
B6	Dust Sensor Board	Analog Input	0-5VDC
B7	Suction Temperature Sensor	Analog Input	10K Ohm Curve J
GND	Analog Ground		
+VDC	24VDC to Outdoor Humidity Sensor		
B8	Liquid Pressure Transducer	Analog Input	.5VDC to 4.5VDC
B9	Suction Pressure Transducer	Analog Input	.5VDC to 4.5VDC
GND	Ground		
Y1	Blower Motor Signal	Analog Output	0-10VDC
Y2	Damper Actuator Signal	Analog Output	0-10VDC
Y3	Condenser Fan Motor Signal	Analog Output	0-10VDC
C1	24VAC+	Power	
NO1	to CCM "Y"	Relay Output	
NO2	Compressor Staging Solenoid	Relay Output	
NO3	Not Used		
C4	24VAC+	Power	
NO4	Stage 1 Heating	Relay Output	
NO5	Not Used		
NO6	Not Used		
NO7	Not Used		
C7	Not Used		
NC7	Not Used		
C8	24VAC+	Power	
NO8	Dirty Filter Light	Relay Output	
NO9	Not Used		
G0	24VAC Common		
G	24VAC Hot		

FIGURE 58
FUSION-TEC WR Series Wall-Mount Unit Model Nomenclature

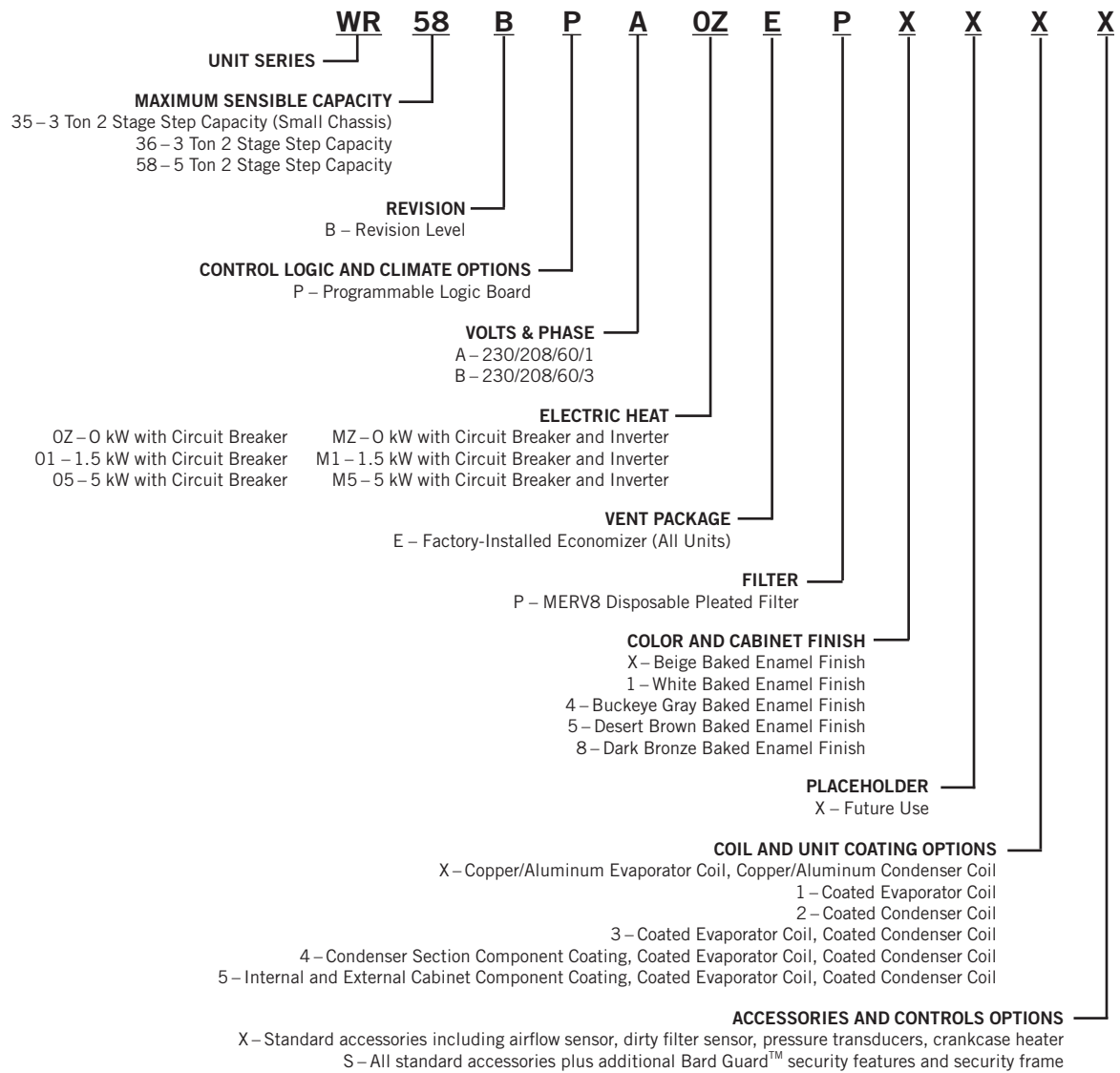

REFRIGERANT INFORMATION

NOTICE

These units require R-410A refrigerant and polyol ester oil.

General

1. Use separate service equipment to avoid cross contamination of oil and refrigerants.
2. Use recovery equipment rated for R-410A refrigerant.
3. Use manifold gauges rated for R-410A (800 PSI/250 PSI low).
4. R-410A is a binary blend of HFC-32 and HFC-125.
5. R-410A is nearly azeotropic—similar to R-22 and R-12. Although nearly azeotropic, charge with liquid refrigerant.
6. R-410A operates at 40-70% higher pressure than R-22, and systems designed for R-22 cannot withstand this higher pressure.
7. R-410A has an ozone depletion potential of zero, but must be reclaimed due to its global warming potential.
8. R-410A compressors use polyol ester oil.
9. Polyol ester oil is hygroscopic; it will rapidly absorb moisture and strongly hold this moisture in the oil.
10. A liquid line dryer must be used—even a deep vacuum will not separate moisture from the oil.
11. Limit atmospheric exposure to 15 minutes.
12. If compressor removal is necessary, always plug compressor immediately after removal. Purge with small amount of nitrogen when inserting plugs.

Topping Off System Charge

If a leak has occurred in the system, Bard Manufacturing recommends reclaiming, evacuating (see criteria above) and charging to the nameplate charge. If done correctly, topping off the system charge can be done without problems.

With R-410A, there are no significant changes in the refrigerant composition during multiple leaks and recharges. R-410A refrigerant is close to being an azeotropic blend (it behaves like a pure compound or single component refrigerant). The remaining refrigerant charge in the system may be used after leaks have occurred. “Top-off” the charge by utilizing the pressure charts on the inner control panel cover as a guideline.

REMEMBER: When adding R-410A refrigerant, it must come out of the charging cylinder/tank as a liquid to avoid any fractionation and to insure optimal system performance. Refer to instructions for the cylinder that is being utilized for proper method of liquid extraction.

Safety Practices

1. Never mix R-410A with other refrigerants.
2. Use gloves and safety glasses. Polyol ester oils can be irritating to the skin, and liquid refrigerant will freeze the skin.
3. Never use air and R-410A to leak check; the mixture may become flammable.
4. Do not inhale R-410A—the vapor attacks the nervous system, creating dizziness, loss of coordination and slurred speech. Cardiac irregularities, unconsciousness and ultimately death can result from breathing this concentration.
5. Do not burn R-410A. This decomposition produces hazardous vapors. Evacuate the area if exposed.
6. Use only cylinders rated DOT4BA/4BW 400.
7. Never fill cylinders over 80% of total capacity.
8. Store cylinders in a cool area, out of direct sunlight.
9. Never heat cylinders above 125°F.
10. Never trap liquid R-410A in manifold sets, gauge lines or cylinders. R-410A expands significantly at warmer temperatures. Once a cylinder or line is full of liquid, any further rise in temperature will cause it to burst.

Important Installer Note

For improved start-up performance, wash the indoor coil with a dishwashing detergent.

R410-A Refrigerant Charge

This wall-mount unit was charged at the factory with the quantity of refrigerant listed on the serial plate. AHRI capacity and efficiency ratings were determined by testing with this refrigerant charge quantity.

Table 12 shows nominal pressures for the units. Since many installation specific situations can affect the pressure readings, this information should only be used by certified technicians as a guide for evaluating proper system performance. They shall not be used to adjust charge. If charge is in doubt, reclaim, evacuate and recharge the wall-mount unit to the serial plate charge.

Pressure Service Ports

High and low pressure service ports are installed on all wall-mount units so that the system operating pressures can be observed. Pressures are shown in Table 12.

This unit employs high-flow Coremax valves instead of the typical Schrader type valves.

WARNING! Do NOT use a Schrader valve core removal tool with these valves. Use of such a tool could result in eye injuries or refrigerant burns!

To change a Coremax valve without first removing the refrigerant, a special tool is required which can be obtained at www.fastestinc.com/en/SCCA07H. See the replacement parts manual for replacement core part numbers.

**TABLE 12
Cooling Pressures**

Full Load Cooling			Air Temperature Entering Outdoor Coil °F										
Model	Return Air Temp (DB/WB)	Pressure	75	80	85	90	95	100	105	110	115	120	125
WR35	75/62	Low Side	131	133	135	136	137	138	139	140	142	143	144
		High Side	309	332	354	378	405	431	458	487	517	548	580
	80/67	Low Side	140	142	144	145	147	148	149	150	152	153	154
		High Side	317	340	363	388	415	442	470	499	530	562	595
	85/72	Low Side	145	147	149	150	152	153	154	155	157	158	159
		High Side	328	352	376	402	430	457	486	516	549	582	616
WR36	75/62	Low Side	130	131	132	134	135	136	137	138	139	140	142
		High Side	290	312	334	359	384	411	439	468	498	530	564
	80/67	Low Side	139	140	141	143	144	145	147	148	149	150	152
		High Side	297	320	343	368	394	422	450	480	511	544	578
	85/72	Low Side	144	145	146	148	149	150	152	153	154	155	157
		High Side	307	331	355	381	408	437	466	497	529	563	598
WR58	75/62	Low Side	129	130	131	132	133	134	136	137	137	139	140
		High Side	318	340	365	389	414	440	467	495	527	553	584
	80/67	Low Side	138	139	140	141	142	143	145	146	147	149	150
		High Side	326	349	374	399	425	451	479	508	537	567	599
	85/72	Low Side	143	144	145	146	147	148	150	151	152	154	155
		High Side	337	361	387	413	440	467	496	526	556	587	620

Part Load Cooling			Air Temperature Entering Outdoor Coil °F										
Model	Return Air Temp (DB/WB)	Pressure	75	80	85	90	95	100	105	110	115	120	125
WR35	75/62	Low Side	137	137	137	138	139	140	141	143	144	146	148
		High Side	282	303	326	348	372	397	422	449	476	504	533
	80/67	Low Side	146	147	147	148	149	150	151	153	154	156	158
		High Side	289	311	334	357	382	407	433	460	488	517	547
	85/72	Low Side	151	152	152	153	154	155	156	158	159	161	164
		High Side	299	322	346	369	395	421	448	476	505	535	566
WR36	75/62	Low Side	119	125	131	136	140	143	146	148	149	150	149
		High Side	268	288	308	331	354	378	405	432	460	490	522
	80/67	Low Side	127	134	140	145	150	153	156	158	159	160	159
		High Side	275	295	316	339	363	388	415	443	472	503	535
	85/72	Low Side	131	139	145	150	155	158	161	164	165	166	165
		High Side	285	305	327	351	376	402	430	459	489	521	554
WR58	75/62	Low Side	135	136	136	137	137	138	138	140	141	142	143
		High Side	283	304	327	350	375	402	428	456	486	416	547
	80/67	Low Side	144	145	145	146	147	148	148	150	151	152	153
		High Side	290	312	335	359	385	412	439	468	498	529	561
	85/72	Low Side	149	150	150	151	152	153	154	155	156	157	158
		High Side	300	323	347	372	398	426	454	484	515	548	581

Low side pressure ± 4 PSIG; High side pressure ± 10 PSIG

Tables are based upon rated CFM (airflow) across the evaporator coil. If there is any doubt as to correct operating charge being in the system, the charge should be removed and system evacuated and recharged to serial plate charge weight.

NOTE: Pressure table based on high speed condenser fan operation. If condensing pressures appear elevated check condenser fan wiring. See "Condenser Fan Operation" on page 26.

MAINTENANCE

Standard Maintenance Procedures

WARNING

Electrical shock hazard.

Disconnect all power supplies before servicing.

Failure to do so could result in electric shock or death.

CAUTION

Cut hazard.

Wear gloves to avoid contact with sharp edges.

Failure to do so could result in personal injury.

1. Disable system from LC6000 controller (see latest revision of LC6000 Service Instructions 2100-669).
2. Turn off AC breakers at wall-mount units.
3. Check inlet sides of condenser and evaporator coils for obstructions/debris—clean if necessary using a quality manufactured coil cleaning product specific for the evaporator or condenser coil.
 - Condenser coil: Remove the upper side panels from the condenser section. This will give clear access to the inlet side of the coil for cleaning. Follow the coil cleaner manufacturer's directions for necessary safety gear and precautions, as well as for application and use. More than one application may be necessary. Rinse thoroughly.
 - Evaporator coil: Open filter access panels and remove filters. Apply specific evaporator cleaner directly to the inlet side of coil, being very careful not to overspray into insulation or surrounding panels and wiring. Residual cleaner and dissolved debris should drip into the drain pan and leave the unit through the condensate hose. More than one application may be necessary. Rinse thoroughly.
4. Manually spin fan and blower motors to ensure they turn freely. All motors are permanently lubricated, so no oil is necessary.
5. Inspect free cooling damper actuator and linkage.
6. Install new air filter; check for additional filter grilles internal to the structure.
7. Inspect the control panel of the system.
 - Look for insect or rodent activity and remove any nesting materials.
 - Manually push contactor closed, observe for movement—contactor points should have minimal discoloration, no spalling or other signs of arcing. Replace if doubtful.
 - Check field and factory wiring for tightness and look for signs of overheating (discoloration of terminals or wire insulation).
8. Ensure that supply and return registers are not obstructed, and more importantly, are not recycling the air to one another. Adjust supply louvers if necessary to direct discharge air away from any direct route to the return grille.
9. Re-assemble wall-mount unit, turn breakers back on.
10. Enable system to LC6000 controller (see latest revision of LC6000 Service Instructions 2100-669).
11. Repeat steps for additional wall-mount units.

Bard Guard Anti-Theft System Option

While the system is powered, push DISARM/RESET button to disarm the system. Once the button is pushed, the blue LED will illuminate. As long as the blue LED is illuminated, the Bard Guard system is disarmed and will remain disarmed depending on the preset time for up to 250 minutes (default approximately 15 minutes). After the preset time expires, the system will rearm automatically.

For situations that require an individual unit to be disconnected from the Bard Guard security system for an extended period of service time (longer than the maximum 250 minutes disarm time), place a jumper across the appropriate terminals on the BG1000 terminal block to temporarily remove the unit from the security system. **Be sure to remove the jumper from the terminals after service has been completed.**

See the latest revision of BG1000 Installation Instructions 2100-672 for information on operating the BG1000 controller.

8301-067 Outdoor Temperature/Humidity Sensor

8301-067 Sensor Connections

This unit utilizes a two wire 4-10mA signal from the 8301-067 sensor to communicate outdoor humidity and a 10KΩ Type III (AN) thermocouple from the 8301-067 sensor to communicate outdoor temperature. The humidity sensor is connected to the sensor control board via the J13 connector. The thermocouple wires are loose in the sensor housing and require a butt splice connector or wire nut to connect to the main unit wiring harness. See Figure 59 and Figure 60 for sensor wiring and terminal location.

Tables 13 and 14 on pages 46 and 47 are correlation charts for troubleshooting the sensor with a test meter:

Table 13: Temperature to Thermocouple Resistance

Table 14: Relative Humidity to Humidity Sensor Current Output

FIGURE 59
8301-067 Sensor Electrical Connections

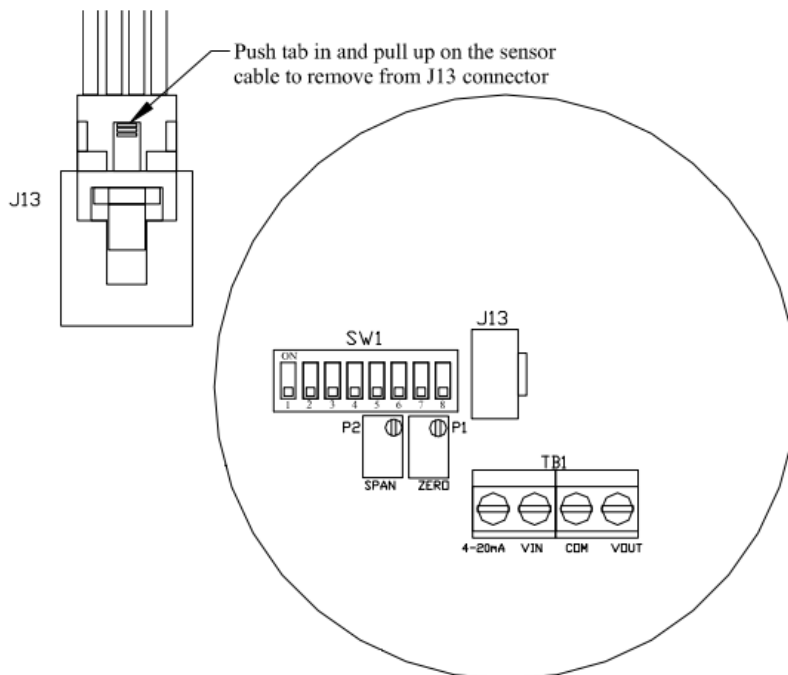

FIGURE 60
8301-067 Sensor Terminal Connections

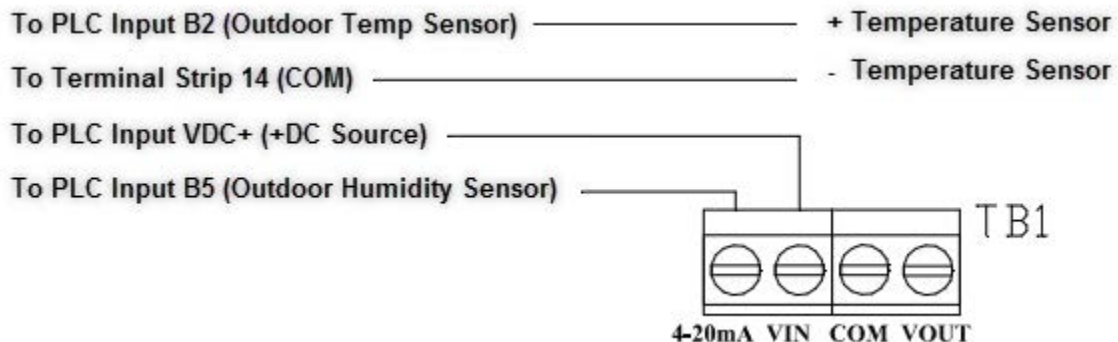

TABLE 13
8301-067 Sensor: Temperature to Thermocouple Resistance

Temperature			Resistance			Temperature			Resistance			Temperature			Resistance		
F	C	Ω	F	C	Ω	F	C	Ω	F	C	Ω	F	C	Ω	F	C	Ω
-25	-31.7	148,453	13	-10.6	48,892	51	10.6	18,338	89	31.7	7680						
-24	-31.1	143,910	14	-10.0	47,572	52	11.1	17,898	90	32.2	7516						
-23	-30.6	139,521	15	-9.4	46,291	53	11.7	17,471	91	32.8	7356						
-22	-30.0	135,281	16	-8.9	45,049	54	12.2	17,055	92	33.3	7200						
-21	-29.4	131,182	17	-8.3	43,844	55	12.8	16,651	93	33.9	7048						
-20	-28.9	127,221	18	-7.8	42,675	56	13.3	16,257	94	34.4	6899						
-19	-28.3	123,393	19	-7.2	41,541	57	13.9	15,873	95	35.0	6754						
-18	-27.8	119,692	20	-6.7	40,441	58	14.4	15,500	96	35.6	6612						
-17	-27.2	116,113	21	-6.1	39,373	59	15.0	15,137	97	36.1	6474						
-16	-26.7	112,654	22	-5.6	38,336	60	15.6	14,783	98	36.7	6339						
-15	-26.1	109,308	23	-5.0	37,330	61	16.1	14,439	99	37.2	6207						
-14	-25.6	106,073	24	-4.4	36,354	62	16.7	14,104	100	37.8	6079						
-13	-25.0	102,943	25	-3.9	35,406	63	17.2	13,777	101	38.3	5953						
-12	-24.4	99,917	26	-3.3	34,486	64	17.8	13,459	102	38.9	5831						
-11	-23.9	96,988	27	-2.8	33,593	65	18.3	13,150	103	39.4	5711						
-10	-23.3	94,155	28	-2.2	32,725	66	18.9	12,848	104	40.0	5594						
-9	-22.8	91,414	29	-1.7	31,883	67	19.4	12,554	105	40.6	5480						
-8	-22.2	88,761	30	-1.1	31,065	68	20.0	12,268	106	41.1	5368						
-7	-21.7	86,194	31	-0.6	30,270	69	20.6	11,989	107	41.7	5259						
-6	-21.1	83,709	32	0.0	29,499	70	21.1	11,718	108	42.2	5153						
-5	-20.6	81,304	33	0.6	28,749	71	21.7	11,453	109	42.8	5049						
-4	-20.0	78,976	34	1.1	28,020	72	22.2	11,195	110	43.3	4947						
-3	-19.4	76,721	35	1.7	27,313	73	22.8	10,943	111	43.9	4848						
-2	-18.9	74,538	36	2.2	26,625	74	23.3	10,698	112	44.4	4751						
-1	-18.3	72,425	37	2.8	25,957	75	23.9	10,460	113	45.0	4656						
0	-17.8	70,377	38	3.3	25,308	76	24.4	10,227	114	45.6	4563						
1	-17.2	68,395	39	3.9	24,676	77	25.0	10,000	115	46.1	4473						
2	-16.7	66,474	40	4.4	24,063	78	25.6	9779	116	46.7	4384						
3	-16.1	64,613	41	5.0	23,467	79	26.1	9563	117	47.2	4298						
4	-15.6	62,811	42	5.6	22,887	80	26.7	9353	118	47.8	4213						
5	-15.0	61,064	43	6.1	22,323	81	27.2	9148	119	48.3	4131						
6	-14.4	59,372	44	6.7	21,775	82	27.8	8948	120	48.9	4050						
7	-13.9	57,731	45	7.2	21,242	83	28.3	8753	121	49.4	3971						
8	-13.3	56,142	46	7.8	20,724	84	28.9	8563	122	50.0	3894						
9	-12.8	54,601	47	8.3	20,220	85	29.4	8377	123	50.6	3818						
10	-12.2	53,107	48	8.9	19,730	86	30.0	8196	124	51.1	3744						
11	-11.7	51,658	49	9.4	19,253	87	30.6	8020	125	51.7	3672						
12	-11.1	50,254	50	10.0	18,789	88	31.1	7848									

TABLE 14
8301-067 Sensor: Relative Humidity to Humidity Sensor Current Output

Humidity	Signal	Humidity	Signal	Humidity	Signal
% RH	mA	% RH	mA	% RH	mA
0	4.000	34	9.440	68	14.880
1	4.160	35	9.600	69	15.040
2	4.320	36	9.760	70	15.200
3	4.480	37	9.920	71	15.360
4	4.640	38	10.080	72	15.520
5	4.800	39	10.240	73	15.680
6	4.960	40	10.400	74	15.840
7	5.120	41	10.560	75	16.000
8	5.280	42	10.720	76	16.160
9	5.440	43	10.880	77	16.320
10	5.600	44	11.040	78	16.480
11	5.760	45	11.200	79	16.640
12	5.920	46	11.360	80	16.800
13	6.080	47	11.520	81	16.960
14	6.240	48	11.680	82	17.120
15	6.400	49	11.840	83	17.280
16	6.560	50	12.000	84	17.440
17	6.720	51	12.160	85	17.600
18	6.880	52	12.320	86	17.760
19	7.040	53	12.480	87	17.920
20	7.200	54	12.640	88	18.080
21	7.360	55	12.800	89	18.240
22	7.520	56	12.960	90	18.400
23	7.680	57	13.120	91	18.560
24	7.840	58	13.280	92	18.720
25	8.000	59	13.440	93	18.880
26	8.160	60	13.600	94	19.040
27	8.320	61	13.760	95	19.200
28	8.480	62	13.920	96	19.360
29	8.640	63	14.080	97	19.520
30	8.800	64	14.240	98	19.680
31	8.960	65	14.400	99	19.840
32	9.120	66	14.560	100	20.000
33	9.280	67	14.720		

8301-067 Humidity Sensor Test Value Outputs

This sensor has the ability to output fixed test signals when testing/troubleshooting sensor operation. These settings are to be used for sensor testing/troubleshooting only and need to be removed before unit can resume normal operation. These settings allow the sensor board to output 0% RH, 50% RH and 100% RH. When these settings are active, the actual humidity sensor is ignored. DIP switches 1, 2 and 3 are used to override the output to a test signal. See Figure 61 for DIP switch/output configuration.

NOTE: If any DIP switches are disrupted, they will need to be returned to the off state in order for the humidity sensor to return to normal operation.

8301-067 Humidity Sensor Calibration

The 8301-067 sensor has the ability to be calibrated via the sensor control board through the use of the DIP switches and/or the use of ZERO P1 or SPAN P2. It is not advised to calibrate this sensor through these means. Any calibration for the unit operation can be done by applying an offset to the sensor input channel using the TEC-EYE service tool.

FIGURE 61
8301-067 DIP Switch/Output Configuration

Test Selection Switches (SW1)

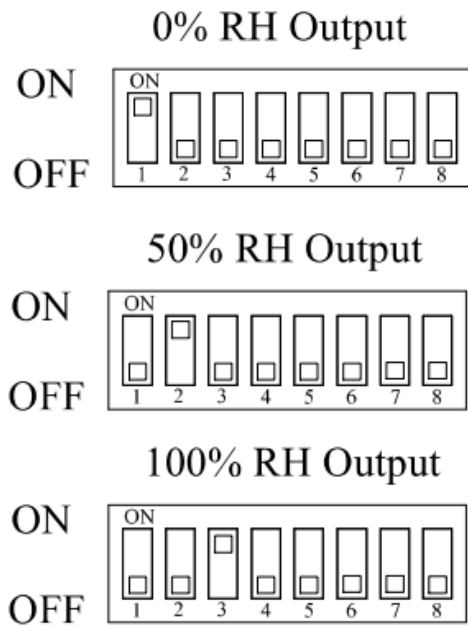

8301-057 Blower Status Switch/Dirty Filter Switch

FIGURE 62
8301-057 Air Differential Switch Terminals

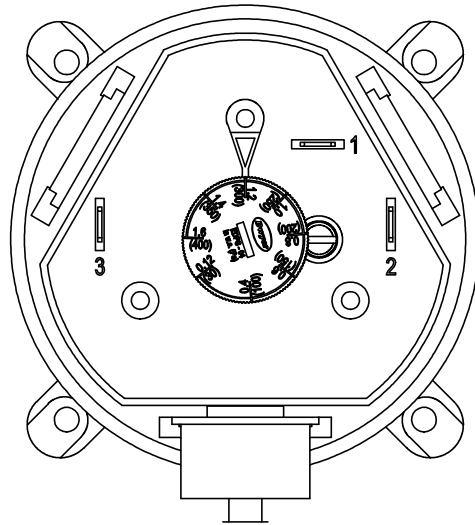

Terminals

- 1 – Normally Closed
- 2 – Normally Open
- 3 – Common

NOTE: Contact position is in resting state.

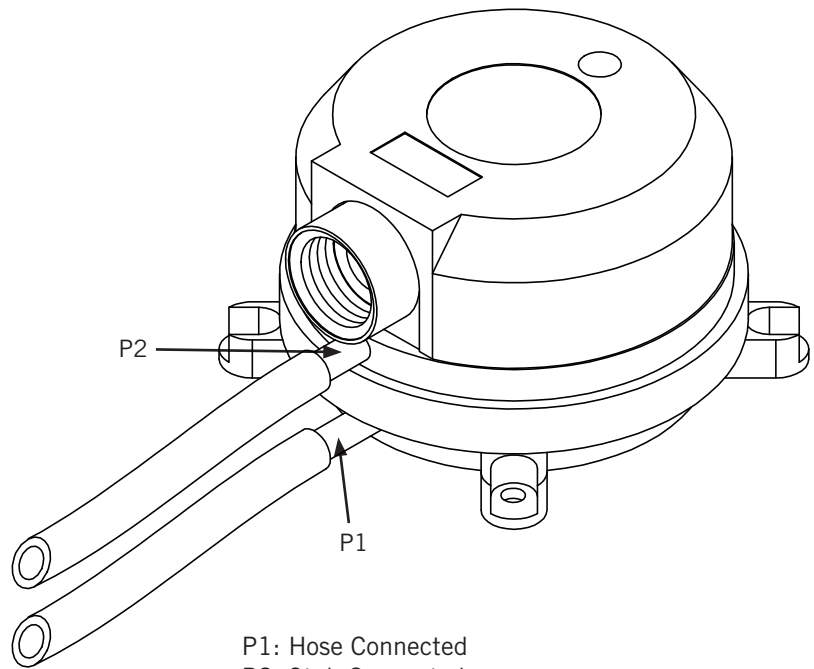

P1: Hose Connected
P2: Stub Connected

8301-073 Dust (Particulate) Sensor

TABLE 15
8301-073 Sensor: Dust/Volts

Dust	Signal	Dust	Signal	Dust	Signal
ppm	Vdc	ppm	Vdc	ppm	Vdc
0	0.00	105	1.70	210	3.40
3	0.05	108	1.75	213	3.45
6	0.10	111	1.80	216	3.50
9	0.15	114	1.84	219	3.54
12	0.19	117	1.89	222	3.59
15	0.24	120	1.94	225	3.64
18	0.29	126	1.99	228	3.69
21	0.34	126	2.04	231	3.74
24	0.39	129	2.09	234	3.79
27	0.44	132	2.14	237	3.83
30	0.49	135	2.18	240	3.88
33	0.53	138	2.23	243	3.93
36	0.58	141	2.28	246	3.98
39	0.63	144	2.33	249	4.03
42	0.68	147	2.38	252	4.08
45	0.73	150	2.43	255	4.13
48	0.78	153	2.48	258	4.17
51	0.83	156	2.52	261	4.22
54	0.87	159	2.57	264	4.27
57	0.92	162	2.62	267	4.32
60	0.97	165	2.67	270	4.37
63	1.02	168	2.72	273	4.42
66	1.07	171	2.77	276	4.47
69	1.12	174	2.82	279	4.51
72	1.17	177	2.86	282	4.56
75	1.21	180	2.91	285	4.61
78	1.26	183	2.96	288	4.66
81	1.31	186	3.01	291	4.71
84	1.36	189	3.06	294	4.76
87	1.41	192	3.11	297	4.81
90	1.46	195	3.16	300	4.85
93	1.50	198	3.20	303	4.90
96	1.55	201	3.25	306	4.95
99	1.60	204	3.30	309	5.00
102	1.65	207	3.35		

8612-061 Dust (Particulate) Sensor Control Board

8612-061 Control Board Output Signal Not Responsive to Dust

1. With a voltmeter, verify 24VAC present across 24VAC pin terminals.
 - A. If 24VAC is not present, trace back wires to source.
2. Inspect and re-seat the dust sensor communication cable.
 - A. Carefully remove the dust sensor communication cable from the dust sensor connector on the dust sensor alarm board and the dust sensor.
 - B. Inspect communication cable for the following:
 - i. Wires pulled out of the connectors.
 - ii. Scars in insulation exposing bare wire.
 - C. If communication cable is damaged:
 - i. Replace communication cable.
 - D. If communication cable is not damaged:
 - i. Carefully reconnect the dust sensor communication cable to the dust sensor connector on the dust sensor alarm board and the dust sensor.
3. With a voltmeter, measure voltage between the following terminals:
 - A. Component U1 pin 2 and terminal block pin 4 (see Figure 64 on page 52).
 - i. Should read 12VAC
 - B. Component U1 pin 3 and terminal block pin 4 (see Figure 64 on page 52).
 - i. Should read 24VAC
 - C. If voltage readings are correct:
 - i. Replace 8301-073 dust sensor.
 - D. If voltage readings are not correct:
 - i. Replace 8612-061 dust sensor alarm board.

FIGURE 63
8612-061 Dust Sensor Alarm Board

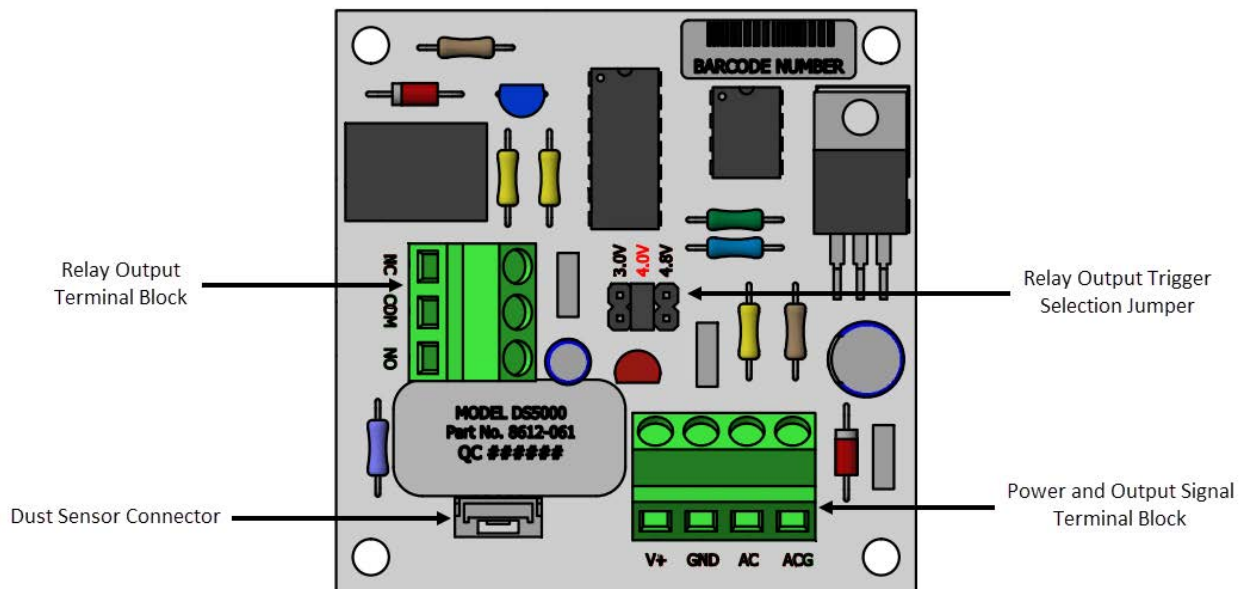
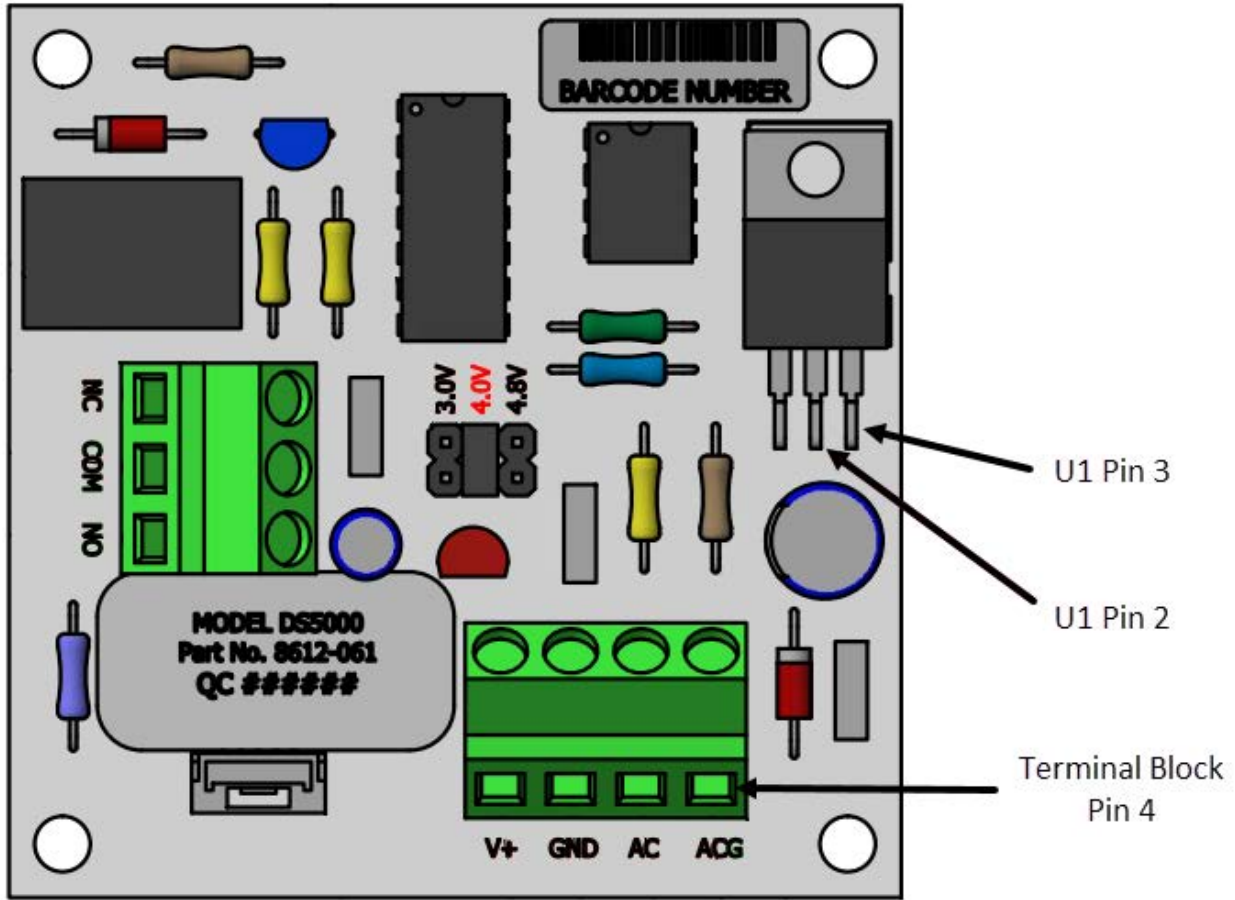

FIGURE 64
Dust Sensor Alarm Board Power Supply Check



8408-044 Return Air Sensor/Suction Sensor

TABLE 16
8408-044 Sensor: Temperature/Resistance Curve J

Temperature		Resistance	Temperature		Resistance	Temperature		Resistance	Temperature		Resistance
°F	°C	Ω	°F	°C	Ω	°F	°C	Ω	°F	°C	Ω
-25	-31.7	196,871	13	-10.6	56,985	53	10.6	19,374	89	31.7	7507
-24	-31.1	190,099	14	-10.0	55,284	52	11.1	18,867	90	32.2	7334
-23	-30.6	183,585	15	-9.4	53,640	53	11.7	18,375	91	32.8	7165
-22	-30.0	177,318	16	-8.9	52,051	54	12.2	17,989	92	33.3	7000
-21	-29.4	171,289	17	-8.3	50,514	55	12.8	17,434	93	33.9	6840
-20	-28.9	165,487	18	-7.8	49,028	56	13.3	16,984	94	34.4	6683
-19	-28.3	159,904	19	-7.2	47,590	57	13.9	16,547	95	35.0	6531
-18	-27.8	154,529	20	-6.7	46,200	58	14.4	16,122	96	35.6	6383
-17	-27.2	149,355	21	-6.1	44,855	59	15.0	15,710	97	36.1	6239
-16	-26.7	144,374	22	-5.6	43,554	60	15.6	15,310	98	36.7	6098
-15	-26.1	139,576	23	-5.0	42,295	61	16.1	14,921	99	37.2	5961
-14	-25.6	134,956	24	-4.4	41,077	62	16.7	14,544	100	37.8	5827
-13	-25.0	130,506	25	-3.9	39,898	63	17.2	14,177	101	38.3	5697
-12	-24.4	126,219	26	-3.3	38,757	64	17.8	13,820	102	38.9	5570
-11	-23.9	122,089	27	-2.8	37,652	65	18.3	13,474	103	39.4	5446
-10	-23.3	118,108	28	-2.2	36,583	66	18.9	13,137	104	40.0	5326
-9	-22.8	114,272	29	-1.7	35,548	67	19.4	12,810	105	40.6	5208
-8	-22.2	110,575	30	-1.1	34,545	68	20.0	12,492	106	41.1	5094
-7	-21.7	107,010	31	-0.6	33,574	69	20.6	12,183	107	41.7	4982
-6	-21.1	103,574	32	0.0	32,634	70	21.1	11,883	108	42.2	4873
-5	-20.6	100,260	33	0.6	31,723	71	21.7	11,591	109	42.8	4767
-4	-20.0	97,064	34	1.1	30,840	72	22.2	11,307	110	43.3	4663
-3	-19.4	93,981	35	1.7	29,986	73	22.8	11,031	111	43.9	4562
-2	-18.9	91,008	36	2.2	29,157	74	23.3	10,762	112	44.4	4464
-1	-18.3	88,139	37	2.8	28,355	75	23.9	10,501	113	45.0	4367
0	-17.8	85,371	38	3.3	27,577	76	24.4	10,247	114	45.6	4274
1	-17.2	82,699	39	3.9	26,823	77	25.0	10,000	115	46.1	4182
2	-16.7	80,121	40	4.4	26,092	78	25.6	9760	116	46.7	4093
3	-16.1	77,632	41	5.0	25,383	79	26.1	9526	117	47.2	4006
4	-15.6	75,230	42	5.6	24,696	80	26.7	9299	118	47.8	3921
5	-15.0	72,910	43	6.1	24,030	81	27.2	9077	119	48.3	3838
6	-14.4	70,670	44	6.7	23,384	82	27.8	8862	120	48.9	3757
7	-13.9	68,507	45	7.2	22,758	83	28.3	8653	121	49.4	3678
8	-13.3	66,418	46	7.8	22,150	84	28.9	8449	122	50.0	3601
9	-12.8	64,399	47	8.3	21,561	85	29.4	8250	123	50.6	3526
10	-12.2	62,449	48	8.9	20,989	86	30.0	8057	124	51.1	3452
11	-11.7	60,565	49	9.4	20,435	87	30.6	7869			
12	-11.1	58,745	50	10.0	19,896	88	31.1	7686			

8301-066 Supply Air Sensor

TABLE 17
8301-066 Sensor: Temperature/Resistance

Temperature		Resistance	Temperature		Resistance	Temperature		Resistance
°F	°C	Ω	°F	°C	Ω	°F	°C	Ω
32	0	29,490	96.8	36	6501	161.6	72	1868
33.8	1	28,157	98.6	37	6260	163.4	73	1810
35.6	2	26,891	100.4	38	6028	165.2	74	1754
37.4	3	25,689	102.2	39	5806	167	75	1700
39.2	4	24,547	104	40	5594	168.8	76	1648
41	5	23,462	105.8	41	5390	170.6	77	1598
42.8	6	22,431	107.6	42	5195	172.4	78	1550
44.6	7	21,450	109.4	43	5007	174.2	79	1503
46.4	8	20,518	111.2	44	4828	176	80	1458
48.2	9	19,631	113	45	4656	177.8	81	1414
50	10	18,787	114.8	46	4490	179.6	82	1372
51.8	11	17,983	116.6	47	4332	181.4	83	1332
53.6	12	17,219	118.4	48	4180	183.2	84	1293
55.4	13	16,490	120.2	49	4034	185	85	1255
57.2	14	15,797	122	50	3893	186.8	86	1218
59	15	15,136	123.8	51	3759	188.6	87	1183
60.8	16	14,506	125.6	52	3629	190.4	88	1149
62.6	17	13,906	127.4	53	3505	192.2	89	1116
64.4	18	13,334	129.2	54	3386	194	90	1084
66.2	19	12,788	131	55	3271	195.8	91	1053
68	20	12,268	132.8	56	3160	197.6	92	1023
69.8	21	11,771	134.6	57	3054	199.4	93	994
71.6	22	11,297	136.4	58	2952	201.2	94	967
73.4	23	10,845	138.2	59	2854	203	95	940
75.2	24	10,413	140	60	2760	204.8	96	913
77	25	10,000	141.8	61	2669	206.6	97	888
78.8	26	9606	143.6	62	2582	208.4	98	864
80.6	27	9229	145.4	63	2498	210.2	99	840
82.4	28	8869	147.2	64	2417	212	100	817
84.2	29	8525	149	65	2339	213.8	101	795
86	30	8196	150.8	66	2264	215.6	102	774
87.8	31	7882	152.6	67	2191	217.4	103	753
89.6	32	7581	154.4	68	2122	219.2	104	733
91.4	33	7293	156.2	69	2055	221	105	713
93.2	34	7018	158	70	1990	222.8	106	694
95	35	6754	159.8	71	1928	224.6	107	676

8406-157 Liquid Line Pressure Transducer

TABLE 18
8406-157 0-650psi Pressure Transducer: Pressure/DC Voltage

Pressure		Signal	Pressure		Signal	Pressure		Signal	Pressure		Signal
PSI	Bar	Vdc	PSI	Bar	Vdc	PSI	Bar	Vdc	PSI	Bar	Vdc
0	0.0	0.500	165	11.2	1.515	330	22.5	2.531	495	33.7	3.546
5	0.3	0.531	170	11.6	1.546	335	22.8	2.562	500	34.0	3.577
10	0.7	0.562	175	11.9	1.577	340	23.1	2.592	505	34.4	3.608
15	1.0	0.592	180	12.2	1.608	345	23.5	2.623	510	34.7	3.639
20	1.4	0.623	185	12.6	1.638	350	23.8	2.654	515	35.0	3.669
25	1.7	0.654	190	12.9	1.669	355	24.2	2.685	520	35.4	3.700
30	2.0	0.685	195	13.3	1.700	360	24.5	2.715	525	35.7	3.731
35	2.4	0.715	200	13.6	1.731	365	24.8	2.746	530	36.1	3.762
40	2.7	0.746	205	13.9	1.762	370	25.2	2.777	535	36.4	3.792
45	3.1	0.777	210	14.3	1.792	375	25.5	2.808	540	36.7	3.823
50	3.4	0.808	215	14.6	1.823	380	25.9	2.839	545	37.1	3.854
55	3.7	0.838	220	15.0	1.854	385	26.2	2.869	550	37.4	3.885
60	4.1	0.869	225	15.3	1.885	390	26.5	2.900	555	37.8	3.915
65	4.4	0.900	230	15.7	1.915	395	26.9	2.931	560	38.1	3.946
70	4.8	0.931	235	16.0	1.946	400	27.2	2.962	565	38.4	3.977
75	5.1	0.962	240	16.3	1.977	405	27.6	2.992	570	38.8	4.008
80	5.4	0.992	245	16.7	2.008	410	27.9	3.023	575	39.1	4.039
85	5.8	1.023	250	17.0	2.039	415	28.2	3.054	580	39.5	4.069
90	6.1	1.054	255	17.4	2.069	420	28.6	3.085	585	39.8	4.100
95	6.5	1.085	260	17.7	2.100	425	28.9	3.115	590	40.1	4.131
100	6.8	1.115	265	18.0	2.131	430	29.3	3.146	595	40.5	4.162
105	7.1	1.146	270	18.4	2.162	435	29.6	3.177	600	40.8	4.192
110	7.5	1.177	275	18.7	2.192	440	29.9	3.208	605	41.2	4.223
115	7.8	1.208	280	19.1	2.223	445	30.3	3.239	610	41.5	4.254
120	8.2	1.238	285	19.4	2.254	450	30.6	3.269	615	41.8	4.285
125	8.5	1.269	290	19.7	2.285	455	31.0	3.300	620	42.2	4.315
130	8.8	1.300	295	20.1	2.315	460	31.3	3.331	625	42.5	4.346
135	9.2	1.331	300	20.4	2.346	465	31.6	3.362	630	42.9	4.377
140	9.5	1.362	305	20.8	2.377	470	32.0	3.392	635	43.2	4.408
145	9.9	1.392	310	21.1	2.408	475	32.3	3.423	640	43.5	4.439
150	10.2	1.423	315	21.4	2.439	480	32.7	3.454	645	43.9	4.469
155	10.5	1.454	320	21.8	2.469	485	33.0	3.485	650	44.2	4.500
160	10.9	1.485	325	22.1	2.500	490	33.3	3.515			

8406-158 Suction Pressure Transducer

TABLE 19
8406-158 0-250psi Pressure Transducer: Pressure/DC Voltage

Pressure			Signal			Pressure			Signal			Pressure			Signal		
PSI	Bar	Vdc	PSI	Bar	Vdc	PSI	Bar	Vdc	PSI	Bar	Vdc	PSI	Bar	Vdc	PSI	Bar	Vdc
0	0.0	0.500	64	4.4	1.524	128	8.7	2.548	192	13.1	3.572						
2	0.1	0.532	66	4.5	1.556	130	8.8	2.580	194	13.2	3.604						
4	0.3	0.564	68	4.6	1.588	132	9.0	2.612	196	13.3	3.636						
6	0.4	0.596	70	4.8	1.620	134	9.1	2.644	198	13.5	3.668						
8	0.5	0.628	72	4.9	1.652	136	9.3	2.676	200	13.6	3.700						
10	0.7	0.660	74	5.0	1.684	138	9.4	2.708	202	13.7	3.732						
12	0.8	0.692	76	5.2	1.716	140	9.5	2.740	204	13.9	3.764						
14	1.0	0.724	78	5.3	1.748	142	9.7	2.772	206	14.0	3.796						
16	1.1	0.756	80	5.4	1.780	144	9.8	2.804	208	14.2	3.828						
18	1.2	0.788	82	5.6	1.812	146	9.9	2.836	210	14.3	3.860						
20	1.4	0.820	84	5.7	1.844	148	10.1	2.868	212	14.4	3.892						
22	1.5	0.852	86	5.9	1.876	150	10.2	2.900	214	14.6	3.924						
24	1.6	0.884	88	6.0	1.908	152	10.3	2.932	216	14.7	3.956						
26	1.8	0.916	90	6.1	1.940	154	10.5	2.964	218	14.8	3.988						
28	1.9	0.948	92	6.3	1.972	156	10.6	2.996	220	15.0	4.020						
30	2.0	0.980	94	6.4	2.004	158	10.8	3.028	222	15.1	4.052						
32	2.2	1.012	96	6.5	2.036	160	10.9	3.060	224	15.2	4.084						
34	2.3	1.044	98	6.7	2.068	162	11.0	3.092	226	15.4	4.116						
36	2.4	1.076	100	6.8	2.100	164	11.2	3.124	228	15.5	4.148						
38	2.6	1.108	102	6.9	2.132	166	11.3	3.156	230	15.7	4.180						
40	2.7	1.140	104	7.1	2.164	168	11.4	3.188	232	15.8	4.212						
42	2.9	1.172	106	7.2	2.196	170	11.6	3.220	234	15.9	4.244						
44	3.0	1.204	108	7.3	2.228	172	11.7	3.252	236	16.1	4.276						
46	3.1	1.236	110	7.5	2.260	174	11.8	3.284	238	16.2	4.308						
48	3.3	1.268	112	7.6	2.292	176	12.0	3.316	240	16.3	4.340						
50	3.4	1.300	114	7.8	2.324	178	12.1	3.348	242	16.5	4.372						
52	3.5	1.332	116	7.9	2.356	180	12.2	3.380	244	16.6	4.404						
54	3.7	1.364	118	8.0	2.388	182	12.4	3.412	246	16.7	4.436						
56	3.8	1.396	120	8.2	2.420	184	12.5	3.444	248	16.9	4.468						
58	3.9	1.428	122	8.3	2.452	186	12.7	3.476	250	17.0	4.500						
60	4.1	1.460	124	8.4	2.484	188	12.8	3.508									
62	4.2	1.492	126	8.6	2.516	190	12.9	3.540									