INSTALLATION INSTRUCTIONS

Bard Air Conditioning System



**MULTI-TEC®
Wall-Mount
Air Conditioner**



**LC6000-200
Supervisory
Controller**



Climate Control Solutions

Bard Manufacturing Company, Inc.
Bryan, Ohio 43506
www.bardhvac.com

Manual: 2100-676D
Supersedes: 2100-676C
Date: 3-18-19

CONTENTS

General Information	3
List of Necessary Materials/Tools	6
Site Preparation	7
Model Identification	7
New Shelter Installation vs. Retrofit Installation	7
Minimum Clearance	7
Clearance to Combustibles	7
Wall-Mount Unit Mounting	9
Mounting the Units	9
Supply Air Grill Installation	10
Wall-Mount Unit Wiring	17
Main Power Wiring	17
Low Voltage Wiring	17
Preliminary Start Up	21
Running in Orphan Mode	21
LC6000 Controller Installation	22
LC6000 Controller	23
Mounting the LC Controller	23
Installing Remote Indoor Temperature/Humidity Sensor(s)	24
Installing Outdoor Temperature/Humidity Sensor	26

FIGURES AND TABLES

Figure 1	MULTI-TEC Model Nomenclature	6
Figure 2	Dimensions	8
Figure 3	Outdoor Sensor Installation	9
Figure 4A	W18/24 Mounting Instructions	10
Figure 4B	W30/36 Mounting Instructions	11
Figure 4C	W42/48 Mounting Instructions	12
Figure 4D	W60/72 Mounting Instructions	13
Figure 5	Electric Heat Clearance	14
Figure 6	Wall Mounting Instructions	14
Figure 7	Wall Mounting Instructions	15
Figure 8	Common Wall Mounting Installations	16
Figure 9	Circuit Routing Label	17
Figure 10	WIRING: VAC Supply Wiring Landing Points ..	17
Figure 11	Cooling and Heating Setpoints	21
Figure 12	Typical LC6000-200 Component Location ..	22
Figure 13	LC6000 Fused Power Supply Terminal	22
Figure 14	Remote Indoor Temperature/Humidity Sensor Installation	24
Figure 15	Additional Remote Sensor Installation	25
Figure 16	Remote Outdoor Sensor Installation	26
Figure 17	Emergency Off, Emergency Vent and Generator Run Connections	27
Figure 18	Communication Wiring (Daisy Chain)	28
Figure 19	Communication Wiring (Alt. Method)	28
Figure 20	Placement of Communication Filters	29
Figure 21	Communication Wiring: Termination at the Controller	30
Figure 22	Communication Wiring: Termination at the First Wall-Mount Unit	31
Figure 23	Communication Wiring: Termination at Additional Wall-Mount Units	32
Figure 24	LC6000 Controller Circuit Install	33
Figure 25	Controller Grounding Posts	34
Figure 26	WIRING: LC6000-200 Wiring Diagram	35
Figure 27	TEC-EYE Connection to Unit Control	36

Emergency Off, Emergency Vent and Generator Run Connections	27
Communication Wiring	28
Supply Wiring	33
System Set Up	36
TEC-EYE Hand-Held Diagnostic Tool	36
TEC-EYE Status Screen	37
Setting Up Wall-Mount Units for Operation	37
1. Address Each Wall-Mount Unit	37
2. Execute a Run Test on Each Unit	37
3. Clear Unit Alarm Logs on Each Unit	38
Setting Up LC6000 for Operation	38
4. Set LC Controller Date and Time	38
5. Configure Sensors	39
6. Enter Total Number of Units	42
7. Verify Units are Online	42
8. Select Economizer Type for Each Zone	42
9. Clear Controller Alarm Logs	43
10. Complete Installation	43
Additional Information	44
Menu Screens and Password Levels	44
Setpoints	44
Calibrating Sensors	44

Figure 28	TEC-EYE Display and Interface	36
Figure 29	Unit Configuration	37
Figure 30	Executing Run Test	38
Figure 31	Clearing Unit Alarm Logs	38
Figure 32	Setting Controller Date and Time	39
Figure 33	Enable/Disable Zone 1 Indoor Humidity Sensor	39
Figure 34	LC6000 Controller Display and Interface	39
Figure 35	Enable/Disable Zone 2 Indoor Humidity Sensor	40
Figure 36	Enable/Disable Zone 3 Indoor Humidity Sensor	40
Figure 37	Enable/Disable Zone 1 Indoor Temperature Sensor	40
Figure 38	Enable/Disable Zone 1 Remote Temperature Sensor	41
Figure 39	Enable/Disable Zone 2 Remote Temperature Sensor	41
Figure 40	Enable/Disable Zone 3 Remote Temperature Sensor	41
Figure 41	Enable/Disable Outdoor Air Humidity Sensor ..	41
Figure 42	Enable/Disable Outdoor Air Temperature Sensor	42
Figure 43	Total Units Displayed	42
Figure 44	Selecting Economizer Type	43
Figure 45	Clearing LC6000 Alarm Logs	44
Figure 46	Adjusting Sensor Offset Value	44
Table 1	W**A*P Series Electrical Specifications	18
Table 2	W**L*P Series Electrical Specifications	19
Table 3	W**A*E Series Electrical Specifications	20
Table 4	LC6000-200 Terminal Block Index	34
Table 5	LC6000/TEC-EYE Passwords (Default)	36
Table 6	MULTI-TEC Unit Status Messages	45
Table 7	LC6000 Status Messages	45

GENERAL INFORMATION

Air Conditioning System

This Bard air conditioning system is composed of MULTI-TEC wall-mounted air conditioners matched with an LC6000 supervisory controller or Bard th-TUNE stand-alone controller. If only one wall-mounted air conditioner is being used, it can be matched with either the LC6000 supervisory controller or a th-TUNE stand-alone controller (see page 3 for information on the th-TUNE). If more than one wall mount is installed, the LC6000 controller must be matched with the air conditioning units. The wall-mount units are specifically engineered for telecom/ motor control center rooms.

NOTE: The LC6000 supervisory controller and MULTI-TEC wall-mount units are designed specifically to work together. The controller cannot run other brands of systems, nor can other controllers run the MULTI-TEC wall-mount units. They are a complete system, and must be used together.

Controller

LC6000 controller and accessories shown below.

LC6000-200 Series Controller and Accessories Included with Controller



(1) LC6000 Programmable Logic Controller

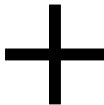

(1) TEC-EYE™ Hand-Held Diagnostic Tool
Bard P/N 8301-059



(1) Remote Temperature/Humidity Sensor¹
Bard P/N 8403-079



(1) 35' 5-Wire 18 Gauge Shielded Cable



(2) Communication EMI Filters
Bard P/N 8301-055

Optional Sensors:



Outside Air
Temperature/Humidity Sensor
Bard P/N 8301-090



Remote
Temperature/Humidity Sensor¹
Bard P/N 8403-079



Remote
Temperature Only Sensor
Bard P/N 8301-058

¹ One remote temperature/humidity sensor is included with the LC6000 controller. If the site in which the LC6000 controller will be used has more than one zone (maximum three zones per LC6000), additional remote temperature/humidity sensors (one sensor per zone) will need to be purchased and installed in the additional zones. One additional temperature-only sensor (Bard P/N 8301-058) may also be used in Zone 1 but will also need to be purchased separately. Additional temperature/humidity sensors require field-supplied 5-wire 18 gauge shielded cable. Temperature-only sensors require field-supplied 2-wire 18 gauge shielded cable.

Wall-Mount Air Conditioner Units

The MULTI-TEC units will supply 100% of rated cooling airflow in freecooling mode with ability to exhaust the same amount through the unit itself without any additional relief openings in the shelter.

MULTI-TEC units are available with optional electric heat and/or dehumidification.

Single Unit Operation

A th-TUNE stand-alone controller (Bard P/N 8403-088) can be used in place of the LC6000 controller when only one MULTI-TEC wall-mount air conditioner is being installed. If using a th-TUNE stand-alone controller instead of the LC6000 controller, the alarm logging and remote communication capabilities of the LC6000 controller will not be available. See th-TUNE manual 2100-678 for information on installing and setting up a th-TUNE stand-alone controller for single unit operation. A TEC-EYE hand-held diagnostic tool is required to program the wall-mount unit for th-TUNE stand-alone controller operation. The th-TUNE stand-alone controller and TEC-EYE diagnostic tool are available as a kit (Bard P/N 8620-264).

General

The equipment covered in this manual is to be installed by trained, experienced service and installation technicians.

The refrigerant system is completely assembled and charged. All internal wiring is complete.

The unit is designed for use with or without duct work. Flanges are provided for attaching the supply and return ducts.

These instructions explain the recommended method to install the air cooled self-contained unit and the electrical wiring connections to the unit.

These instructions and any instructions packaged with any separate equipment required to make up the entire air conditioning system should be carefully read before beginning the installation. Note particularly any tags and/or labels attached to the equipment.

While these instructions are intended as a general recommended guide, they do not supersede any national and/or local codes in any way. Authorities having jurisdiction should be consulted before the installation is made. See **Additional Publications** for information on codes and standards.

Sizing of systems for proposed installation should be based on heat loss and heat gain calculations made according to methods of Air Conditioning Contractors of America (ACCA). The supply flange should be installed in accordance with the *Standards of the National Fire Protection Association for the Installation of Air Conditioning and Ventilating Systems of Other Than Residence Type, NFPA No. 90A, and Residence Type Warm Air Heating and Air Conditioning Systems, NFPA*

No. 90B. Where local regulations are at a variance with instructions, installer should adhere to local codes.

Shipping Damage

Upon receipt of equipment, the cartons should be checked for external signs of shipping damage. If damage is found, the receiving party must contact the last carrier immediately, preferably in writing, requesting inspection by the carrier's agent.

These units must remain in upright position at all times.

Additional Publications

These publications can help when installing the air conditioner. They can usually be found at the local library or purchased directly from the publisher. Be sure to consult the current edition of each standard.

National Electrical CodeANSI/NFPA 70
Standard for the Installation of Air Conditioning and Ventilating SystemsANSI/NFPA 90A
Standard for Warm Air Heating and Air Conditioning SystemsANSI/NFPA 90B
Load Calculation for Residential Winter and Summer Air Conditioning ACCA Manual J

For more information, contact these publishers:

Air Conditioning Contractors of America (ACCA)

1712 New Hampshire Ave. N.W.
Washington, DC 20009
Telephone: (202) 483-9370 Fax: (202) 234-4721

American National Standards Institute (ANSI)

11 West Street, 13th Floor
New York, NY 10036
Telephone: (212) 642-4900 Fax: (212) 302-1286

American Society of Heating, Refrigeration and Air Conditioning Engineers, Inc. (ASHRAE)

1791 Tullie Circle, N.E.
Atlanta, GA 30329-2305
Telephone: (404) 636-8400 Fax: (404) 321-5478

National Fire Protection Association (NFPA)

Batterymarch Park
P. O. Box 9101
Quincy, MA 02269-9901
Telephone: (800) 344-3555 Fax: (617) 984-7057

ANSI Z535.5 Definitions:

DANGER: Indicate[s] a hazardous situation which, if not avoided, will result in death or serious injury. The signal word “DANGER” is to be limited to the most extreme situations. DANGER [signs] should not be used for property damage hazards unless personal injury risk appropriate to these levels is also involved.

WARNING: Indicate[s] a hazardous situation which, if not avoided, could result in death or serious injury. WARNING [signs] should not be used for property damage hazards unless personal injury risk appropriate to this level is also involved.

CAUTION: Indicate[s] a hazardous situation which, if not avoided, could result in minor or moderate injury. CAUTION [signs] without a safety alert symbol may be used to alert against unsafe practices that can result in property damage only.

NOTICE: [this header is] preferred to address practices not related to personal injury. The safety alert symbol shall not be used with this signal word. As an alternative to “NOTICE” the word “CAUTION” without the safety alert symbol may be used to indicate a message not related to personal injury.



 WARNING
<p><i>Electrical shock hazard.</i></p> <p><i>Have a properly trained individual perform these tasks.</i></p> <p><i>Failure to do so could result in electric shock or death.</i></p>

 WARNING
<p><i>Heavy item hazard.</i></p> <p><i>Use more than one person to handle unit.</i></p> <p><i>Failure to do so could result in unit damage or serious injury.</i></p>

 WARNING
<p><i>Fire hazard.</i></p> <p><i>Maintain minimum 1/4" clearance between the supply air duct and combustible materials in the first 3' of ducting.</i></p> <p><i>Failure to do so could result in fire causing damage, injury or death.</i></p>

 CAUTION
<p><i>Cut hazard.</i></p> <p><i>Wear gloves to avoid contact with sharp edges.</i></p> <p><i>Failure to do so could result in personal injury.</i></p>

LIST OF NECESSARY MATERIALS/TOOLS

Additional hardware and miscellaneous supplies are needed for installation. These items are field supplied and must be sourced before installation. This list also includes tools needed for installation.

List of Materials/Tools

- Personal protective equipment/safety devices/anti-static wrist straps
- Supply and return grilles
- Field-fabricated sleeves (if necessary)
- Fasteners sufficient for mounting the units such as 5/16" diameter anchor/lag bolts
- 7/8" diameter washers
- Fasteners appropriate for the shelter wall construction to attach the controller to the wall
- Commercial grade outdoor silicone sealant
- Miscellaneous hand and power tools and jobsite or shop materials
- Lifting equipment with the necessary capacity and rigging to safely move/install the systems
- Electrical supplies
 - Various size circuit breakers for the shelter AC breaker box (see Tables 1, 2 and 3 on pages 18, 19 and 20)
 - High-voltage wire of various gauges (see Tables 1, 2 and 3)
 - 16 gauge minimum, 14 gauge maximum power wire to connect controller to shelter power source
 - 5-wire, 18 gauge shielded cable for remote temperature and humidity sensors (2-wire, 18 gauge shielded cable for temperature-only sensors)
 - Communication wire: 2-wire, 18 gauge, shielded with drain
 - 18 gauge non-shielded wire for connecting emergency off, emergency vent and/or generator, if applicable, to controller
 - CAT 6 Ethernet cable of field-determined length (for remote communication, if applicable)
 - 2 hole grounding lug (to be used with supplied 1/4" bolts and nuts for grounding controller box)
 - Miscellaneous electrical supplies including rigid/flexible conduit and fittings, 2" x 4" junction boxes (one per temperature/humidity sensor), wire connectors and supports

FIGURE 1
MULTI-TEC Wall-Mount Unit Model Nomenclature

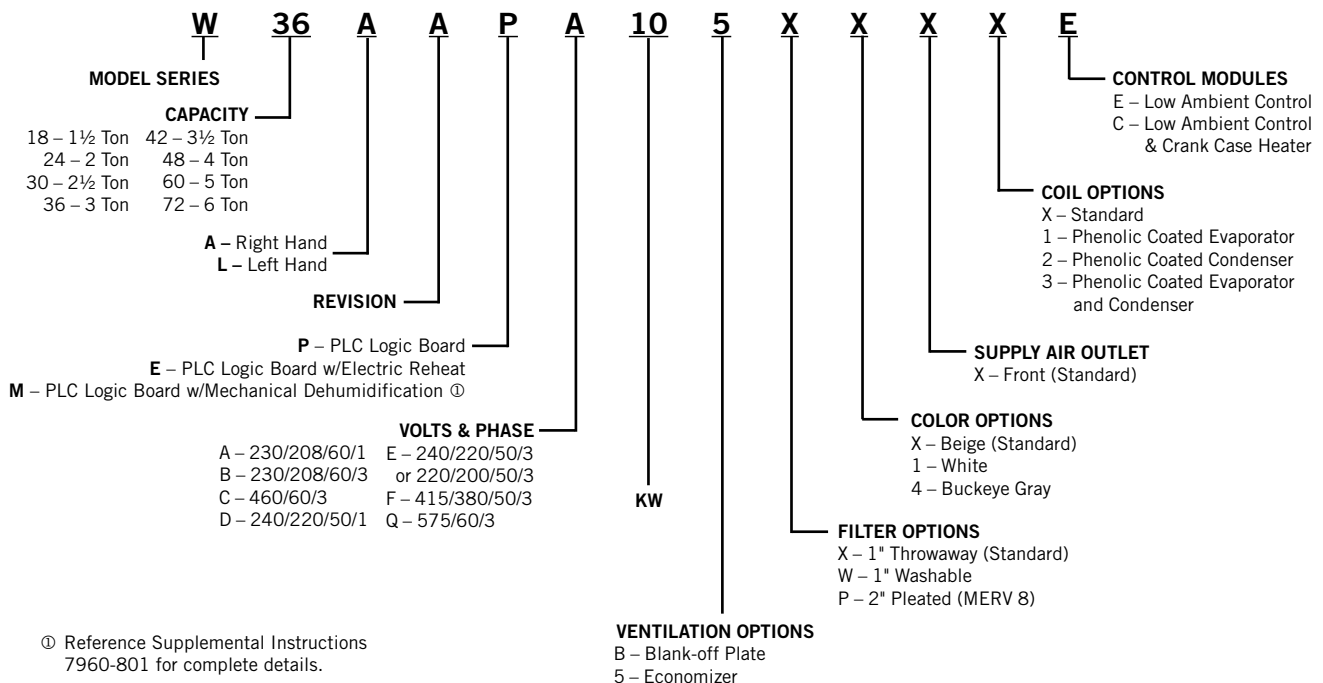

Model Identification

Identify the specific model using the model nomenclature information found in Figure 1 and the model/serial tag found on the unit. See Figure 2 on page 8 for dimensions and critical installation requirements.

New Shelter Installation vs. Retrofit Installation

These installation instructions cover both new shelter installations and retrofit installations. Each installation is unique and may require special accommodations and modifications. Although Bard Manufacturing follows a long-established tradition of manufacturing equipment using industry standard dimensions for building penetration, it is occasionally necessary to move or enlarge supply and return openings when replacing non-standardized equipment in a retrofit application.

Minimum Clearance

Wall-mount air conditioners are available in both right-hand access models and left-hand access models. Right-hand access models have the heat strip access panel, external circuit breakers access panel and internal controls access panel on the right side of the unit. Left-hand access models are a mirror image of the right-hand access models, and allow two wall-mount units to be placed in relatively close proximity and yet still allow complete access for maintenance and repair.

On side-by-side installations, maintain a minimum of 20" clearance on control side to allow access to control panel and heat strips, and to allow proper airflow to the outdoor coil. For installations where units are installed with both control panels facing each other (inward), maintain a minimum of 36" clearance to allow access. Additional clearance may be required to meet local or national codes.

Care should be taken to ensure that the recirculation and obstruction of condenser discharge air does not occur. Recirculation of condenser discharge air can be from either a single unit or multiple units. Any object such as shrubbery, a building or a large object can cause obstructions to the condenser discharge air. Recirculation or reduced airflow caused by obstructions will result in reduced capacity, possible unit pressure safety lockouts and reduced unit service life.

For units with blow through condensers, such as these wall-mount units, it is recommended there be a minimum distance of 10' between the front of the unit and any barrier or 20' between the fronts of two opposing (facing) units.

Clearances Required for Service Access and Adequate Condenser Airflow

MODELS	LEFT SIDE	RIGHT SIDE	DISCHARGE SIDE
W18A, W24A, W30A, W36A	15"	20"	10'
W18L, W24L, W30L, W36L	20"	15"	10'
W42A, W48A, W60A, W72A	20"	20"	10'
W42L, W48L, W60L, W72L	20"	20"	10'

NOTE: For side-by-side installation of two units there must be 20" between units. This can be reduced to 15" by using a W**L model (left side compressor and controls) for the left unit and W**A (right side compressor and controls) for right unit.

See Specifications Sheet S3532.

Clearance to Combustibles

WARNING

Fire hazard.

Maintain minimum 1/4" clearance between the supply air duct and combustible materials in the first 3' of ducting.

Failure to do so could result in fire causing damage, injury or death.

The unit itself is suitable for 0" clearance, but the supply air duct flange and the first 3' of supply air duct require a minimum of 1/4" clearance to combustible material. However, it is generally recommended that a 1" clearance is used for ease of installation and maintaining the required clearance to combustible material. See Figures 4A-D on pages 10-13 for details on opening sizes.

Minimum Clearances Required to Combustible Materials

MODELS	SUPPLY AIR DUCT FIRST 3'	CABINET
W18A, L W24A, L	0"	0"
W30A, L W36A, L	1/4"	0"
W42A, L W48A, L W60A, L W72A, L	1/4"	0"

WALL-MOUNT UNIT MOUNTING

Mounting the Units

WARNING

Heavy item hazard.

Use more than one person to handle unit.

Failure to do so could result in unit damage or serious injury.

NOTE: *It may be best to spot some electrical knockouts (such as those located on the back of the wall-mount unit) before units are mounted and access is unavailable or limited (see Figure 2 to locate pre-punched knockouts).*

Two holes for the supply and return air openings must be cut through the wall as shown in Figures 4A-D on pages 10-13. On wood frame walls, the wall construction must be strong and rigid enough to carry the weight of the unit without transmitting any unit vibration. All walls must be thoroughly inspected to ensure that they are capable of carrying the weight of the installed unit.

In retrofit (unit replacement) installations, the openings cut for the original equipment may not line up exactly with needs of this installation. Modifications may need to be made, such as increasing or decreasing the size of the wall cutouts. The existing bolt placement may not line up in which case the original bolts would need to be removed or cut away.

1. These units are secured by full-length mounting flanges built into the cabinet on each side which secure the unit to the outside wall surface. A bottom mounting bracket, attached to skid for shipping, is provided for ease of installation, but is not required.
2. The unit itself is suitable for 0" clearance, but the supply air duct flange and the first 3' of supply air duct require a minimum of 1/4" clearance to combustible material. However, it is generally recommended that a 1" clearance is used for ease of installation and maintaining the required clearance to combustible material. See Figures 4A-D for details on opening sizes.
3. Locate and mark lag bolt locations and location for optional bottom mounting bracket, if desired (see Figures 4A-D).
4. Mount bottom mounting bracket (if used).

5. If desired, hook top rain flashing (attached to front-right of supply flange for shipping) under back bend of top.
6. Position unit in opening and secure with fasteners sufficient for the application such as 5/16" lag/anchor/carriage bolts; use 7/8" diameter flat washers on the lag bolts. It is recommended that a bead of silicone caulking be placed behind the side mounting flanges.
7. Secure optional rain flashing to wall and caulk across entire length of top (see Figures 4A-D).
8. For additional mounting rigidity, the return air and supply air frames or collars can be drilled and screwed or welded to the structural wall itself (depending upon wall construction). Be sure to observe required clearance if combustible wall.
9. A plastic drain hose extends from the drain pan at the top of the unit down to the unit base. There are openings in the unit base for the drain hose to pass through. In the event the drain hose is connected to a drain system of some type, it must be an open or vented type system to assure proper drainage.
10. Install outdoor temperature/humidity sensor (see Figure 3). Remove grommet from base and sensor. Discard shipping bracket. Place sensor extension through hole in base under condenser fan and secure to base with screw.

FIGURE 3
Outdoor Sensor Installation



FIGURE 4A
W18A, W18L, W24A, W24L
Mounting Instructions

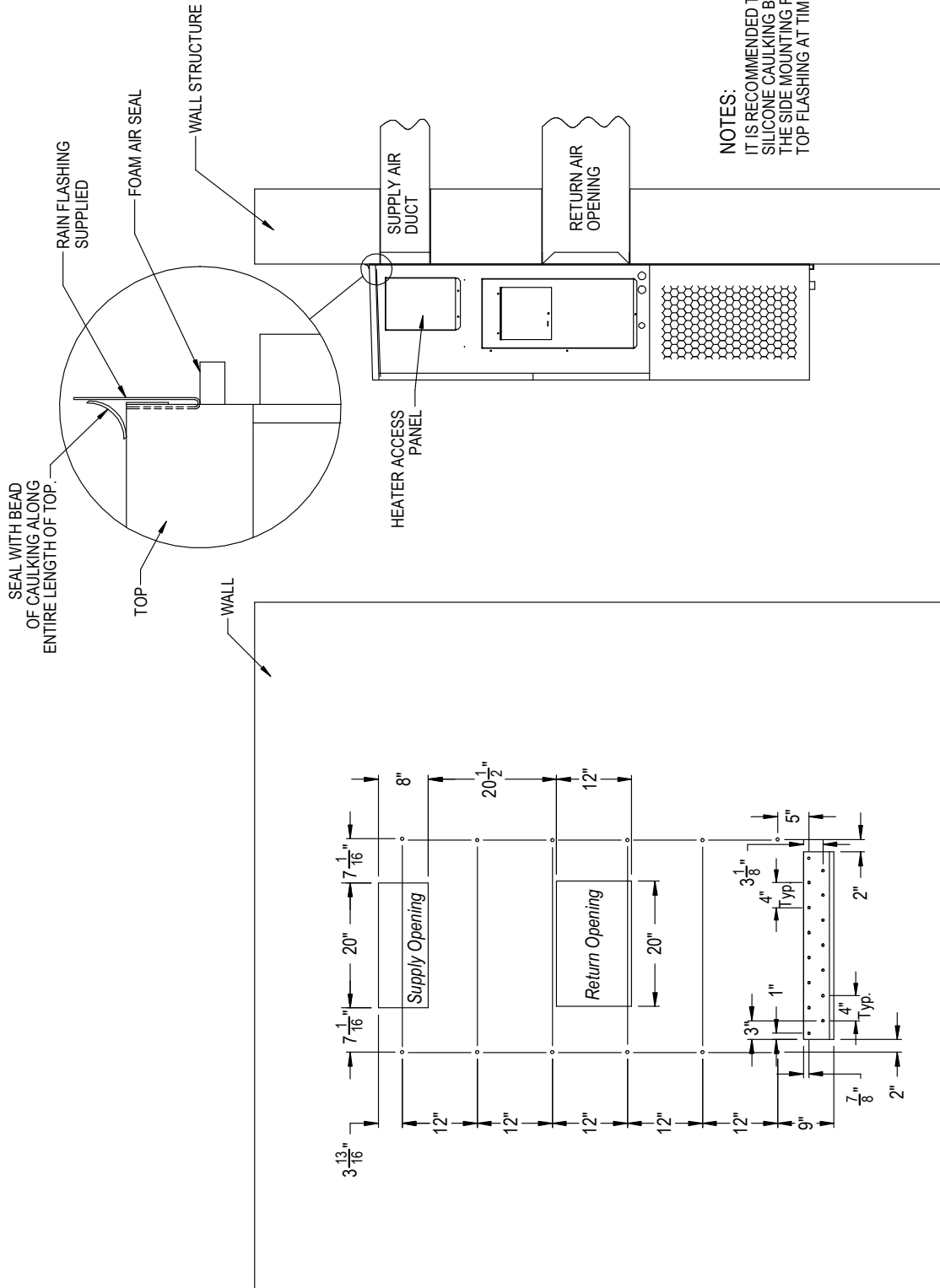

MIS-3157 A

Right Side View

Wall Opening and Hole Location View

FIGURE 4B
W30A, W30L, W36A, W36L
Mounting Instructions

	A	B	C	D	E
REQUIRED DIMENSIONS TO MAINTAIN 1/4" MIN. CLEARANCE FROM COMBUSTIBLE MATERIALS	28 3/8	8 3/8	5 3/8	3 11/16	17 5/8
REQUIRED DIMENSIONS TO MAINTAIN RECOMMENDED 1" CLEARANCE FROM COMBUSTIBLE MATERIALS	29 7/8	9 7/8	4 5/8	4 7/16	16 7/8

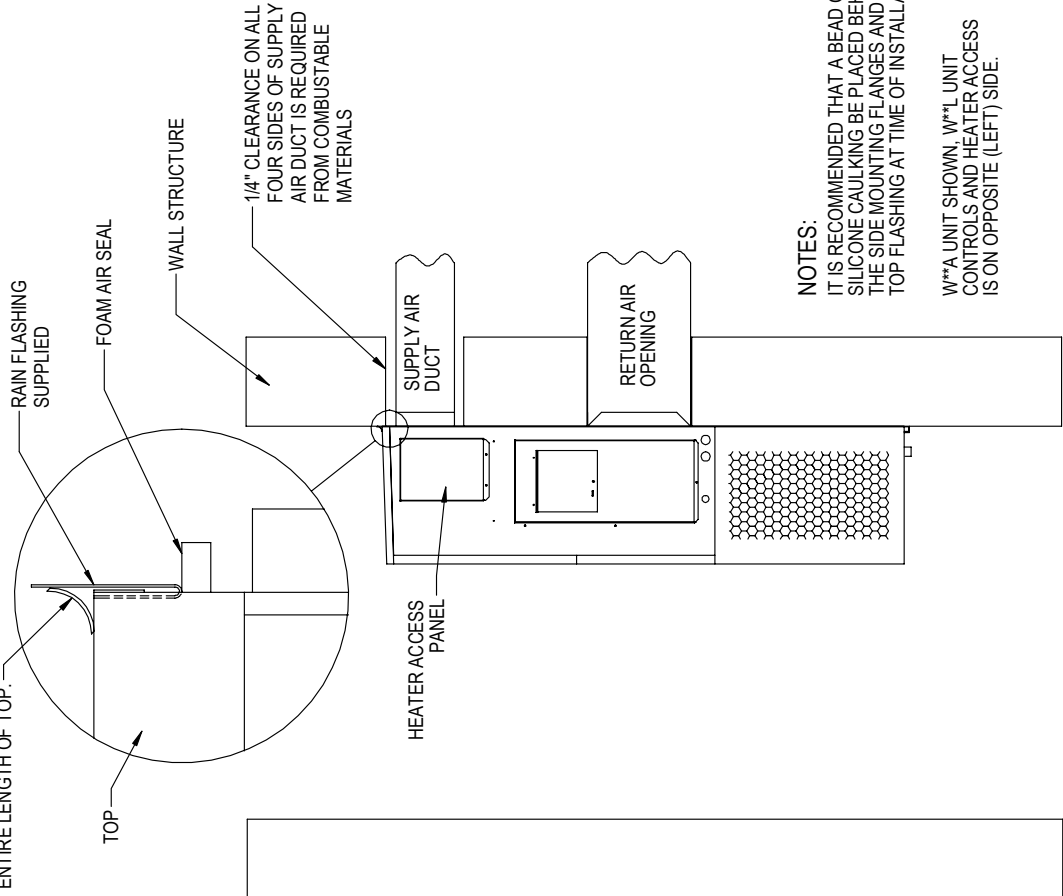

NOTES:
 IT IS RECOMMENDED THAT A BEAD OF SILICONE CAULKING BE PLACED BEHIND THE SIDE MOUNTING FLANGES AND UNDER TOP FLASHING AT TIME OF INSTALLATION.
 W**A UNIT SHOWN, W**L UNIT CONTROLS AND HEATER ACCESS IS ON OPPOSITE (LEFT) SIDE.

Right Side View

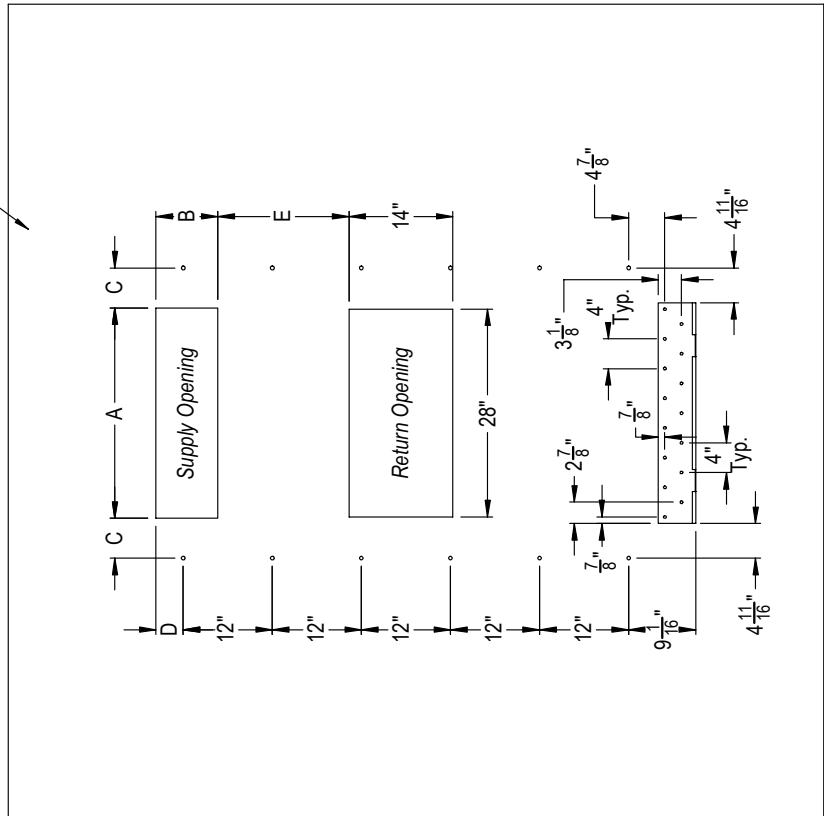

Wall Opening and Hole Location View

MIS-3820

FIGURE 4D
W60A, W60L, W72A, W72L
Mounting Instructions

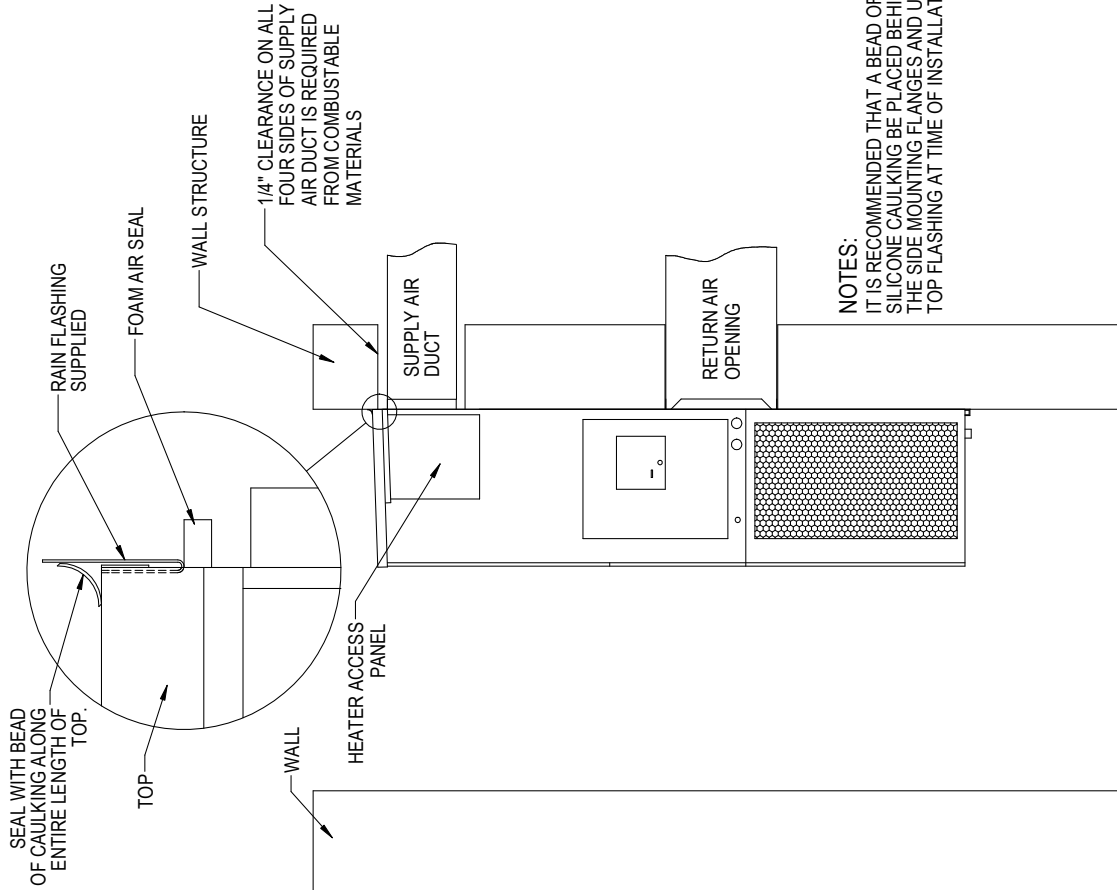

Right Side View

	A	B	C	D	E
REQUIRED DIMENSIONS TO MAINTAIN 1/4" MIN. CLEARANCE FROM COMBUSTIBLE MATERIALS	30 1/2	10 1/2	6 1/4	1 1/4	29 3/4
REQUIRED DIMENSIONS TO MAINTAIN RECOMMENDED 1" CLEARANCE FROM COMBUSTIBLE MATERIALS	32	12	5 1/2	2	29

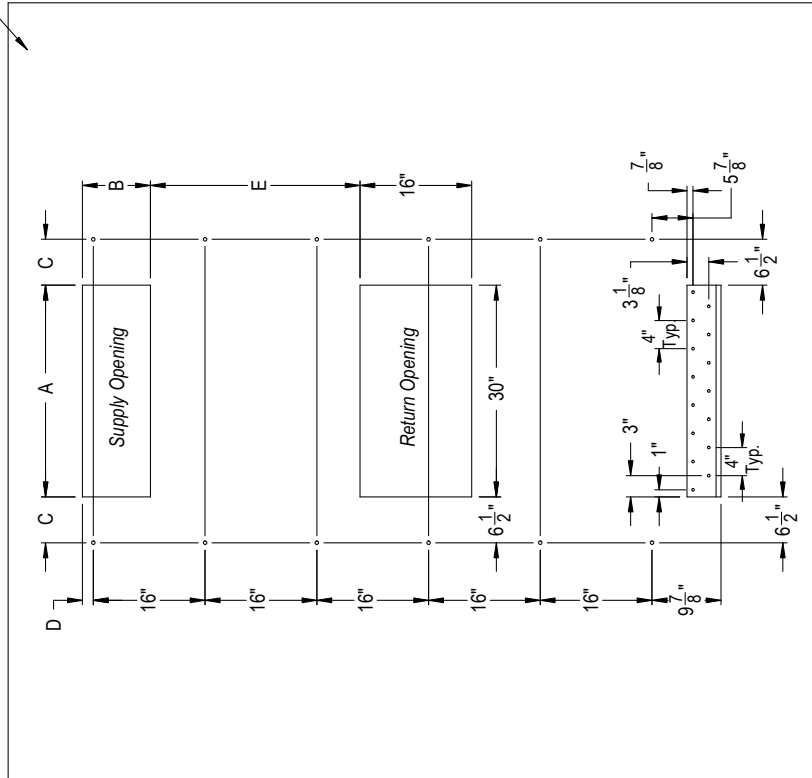

Wall Opening and Hole Location View

FIGURE 5
Electric Heat Clearance

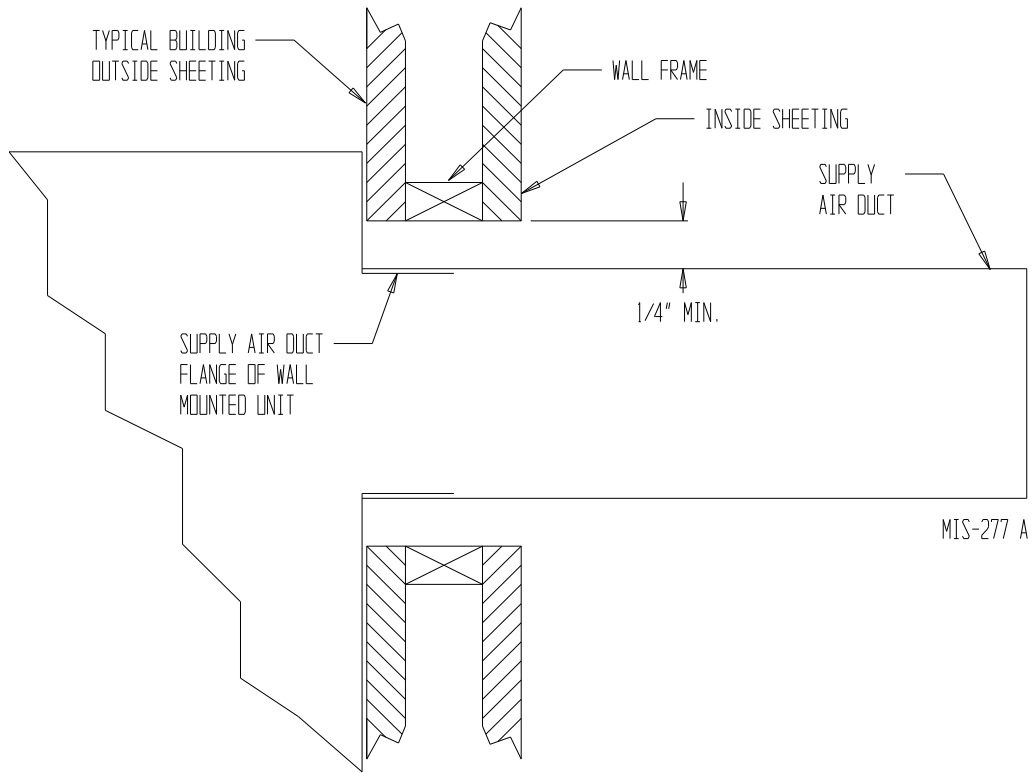

FIGURE 6
Wall Mounting Instructions

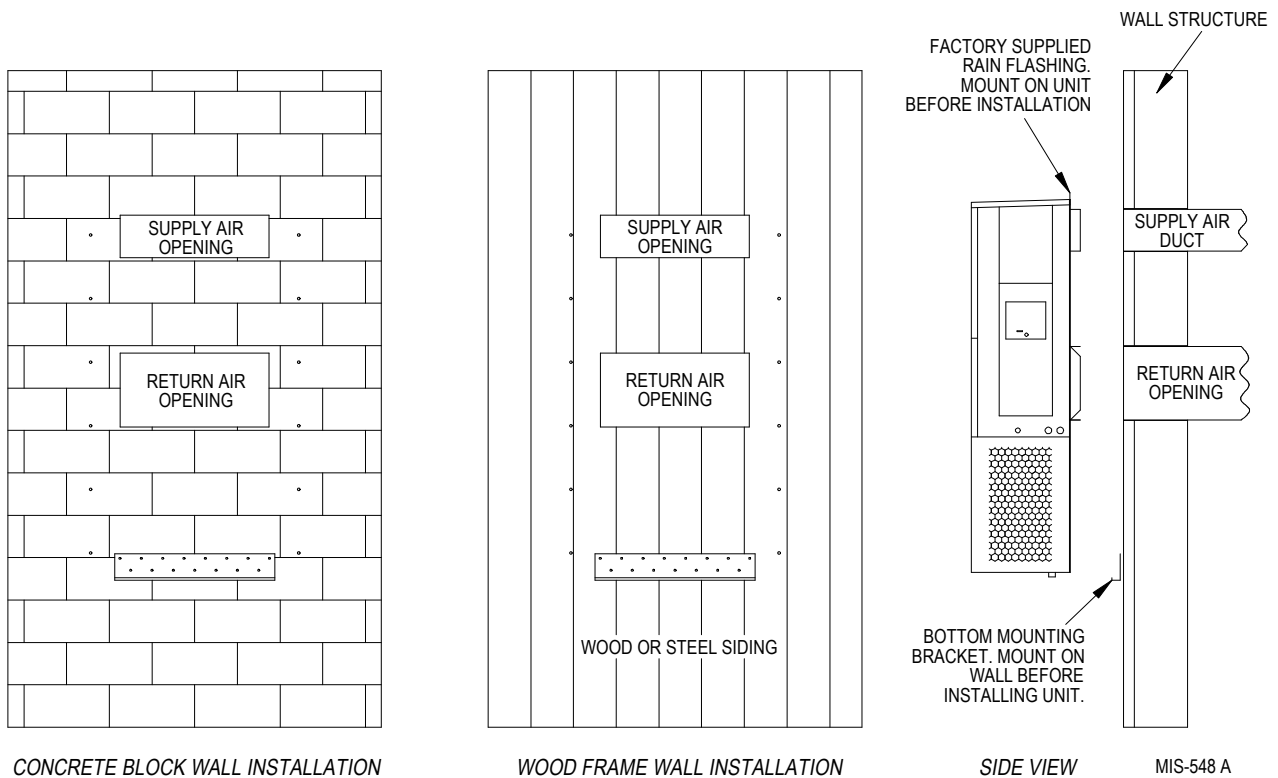

FIGURE 7
Wall Mounting Instructions

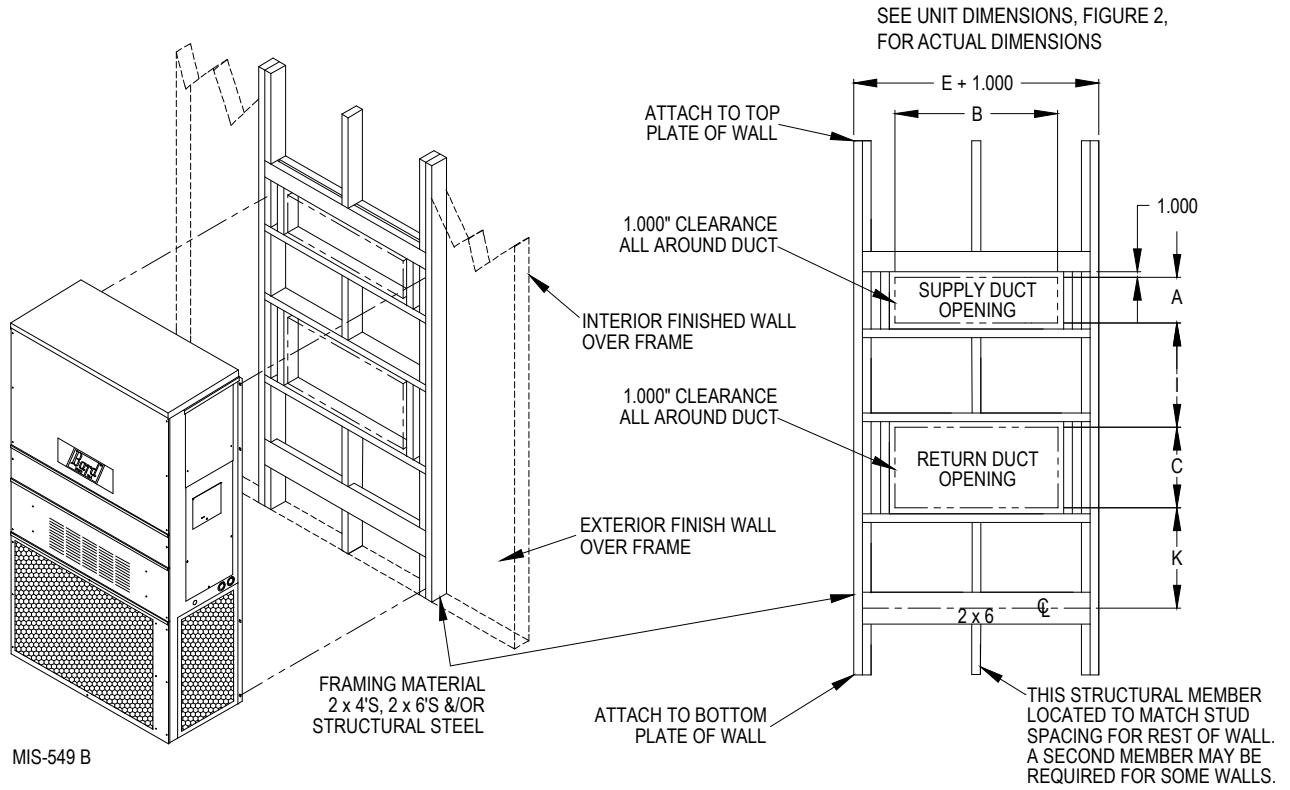
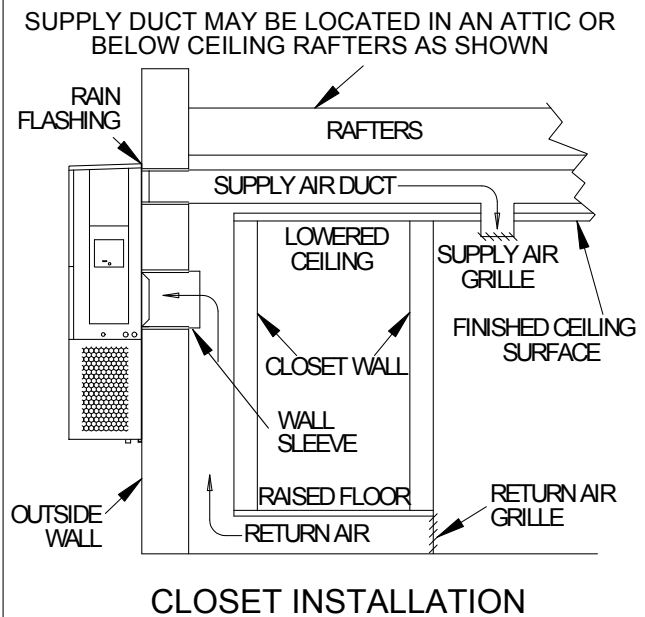
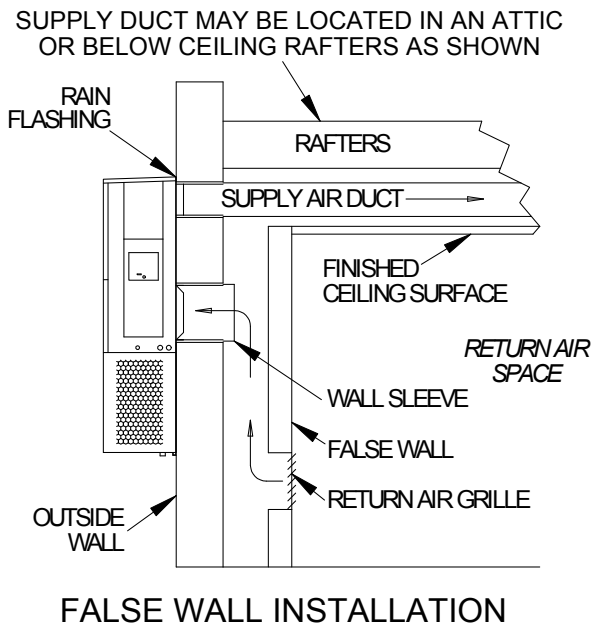
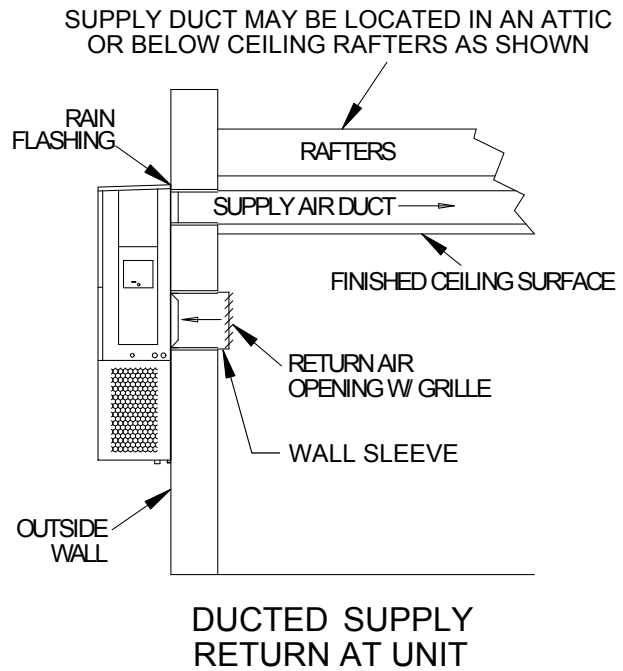
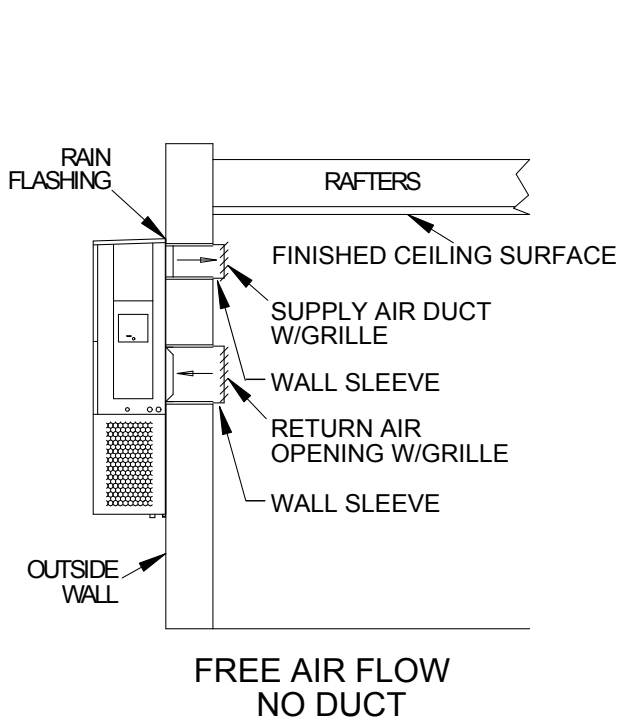

FIGURE 8
Common Wall Mounting Installations



MIS-550 C

WALL-MOUNT UNIT WIRING

WARNING

Electrical shock hazard.

Have a properly trained individual perform these tasks.

Failure to do so could result in electric shock or death.

MAIN POWER WIRING

Refer to the unit rating plate or Table 1 (page 18), Table 2 (page 19) or Table 3 (page 20) for wire sizing information and maximum fuse or circuit breaker size. Each outdoor unit is marked with a “Minimum Circuit Ampacity”. The field wiring used must be sized to carry that amount of current. Depending on the installed KW of electric heat, there may be two field power circuits required. If this is the case, the unit rating plate will so indicate. All models are suitable only for connection with copper wire. Each unit and/or wiring diagram will be marked “Use Copper Conductors Only”. These instructions **must be** adhered to. Refer to the National Electrical Code (NEC) for complete current carrying capacity data on the various insulation grades of wiring material. All wiring must conform to NEC and all local codes.

The unit rating plate and Tables 1, 2 and 3 list fuse and wire sizes (75°C copper) for all models including the most commonly used heater sizes. Also shown are the number of field power circuits required for the various models with heaters.

The unit rating plate lists a maximum circuit breaker or fuse that is to be used with the equipment. The correct size must be used for proper circuit protection and also to assure that there will be no nuisance tripping due to the momentary high starting current of the compressor motor.

Route all field wires to the right of the wire shield as shown in the circuit routing label found in Figure 9 (and also on the wall-mount units).

See Figure 10 to reference VAC landing points.

The disconnect access door on this unit may be locked to prevent unauthorized access to the disconnect. To convert for the locking capability, bend the tab located in the bottom left-hand corner of the disconnect opening under the disconnect access panel straight out. This tab will now line up with the slot in the door. When shut, a padlock may be placed through the hole in the tab preventing entry.

FIGURE 9
Circuit Routing Label

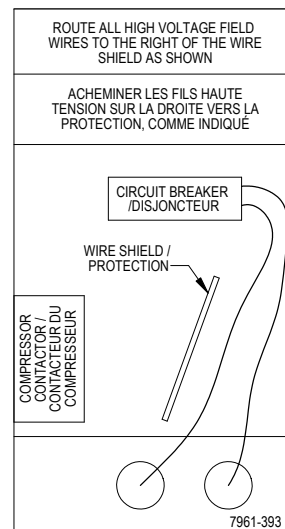
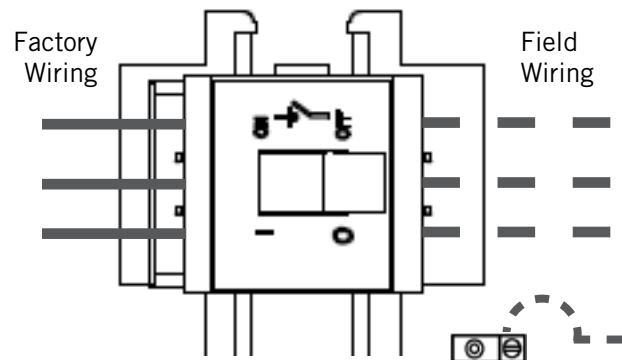

FIGURE 10
VAC Supply Wiring Landing Points



NOTE: Right-hand access model wiring landing points are shown here; left-hand access models will mirror this image.

LOW VOLTAGE WIRING

230/208V 1 phase and 3 phase equipment use dual primary voltage transformers. All equipment leaves the factory wired on 240V tap. **It is very important that the correct voltage tap is used.** For 208V operation, reconnect from 240V to 208V tap. The acceptable operating voltage range for the 240 and 208V taps are: 240V Tap (253 – 216) and 208 Tap (220 – 197).

NOTE: The voltage should be measured at the field power connection point in the unit and while the unit is operating at full load (maximum amperage operating condition).

For low voltage wiring, an 18 gauge copper, color-coded cable is recommended.

TABLE 1

Electrical Specifications – W**A*P Series																		
MODEL	Rated Volts & Phase	No. Field Power Circuits	Single Circuit				Multiple Circuit											
			③ Minimum Circuit Ampacity	① Maximum External Fuse or Ckt. Brkr.	② Field Power Wire Size	② Ground Wire	③ Minimum Circuit Ampacity			① Maximum External Fuse or Ckt. Breaker			② Field Power Wire Size			② Ground Wire Size		
							Ckt. A	Ckt. B	Ckt. C	Ckt. A	Ckt. B	Ckt. C	Ckt. A	Ckt. B	Ckt. C	Ckt. A	Ckt. B	Ckt. C
W18AAPA00, AOZ	230/208-1	1	16	20	12	12												
A05		1	30	30	10	10												
A08		1	46	50	8	10												
A10		1	56	60	6	10												
W24AAPA00, AOZ	230/208-1	1	21	30	10	10												
A04		1	25	30	10	10												
A05		1	30	30	10	10												
A08		1	46	50	8	10												
A10	1	56	60	6	10													
W24AAPB00, BOZ	230/208-3	1	15	20	12	12												
B06		1	22	25	10	10												
W24AAPC00, COZ	460-3	1	9	15	14	14												
C06		1	11	15	14	14												
W30AAPA00, AOZ	230/208-1	1	26	35	8	10												
A05		1	32	35	8	10												
A08		1	47	50	8	10												
A10		1	58	60	6	10												
A15		1 or 2	84	90	4	8	58	26		60	30		6	10		10	10	
W30AAPB00, BOZ	230/208-3	1	19	20	12	12												
B06		1	24	25	10	10												
B09		1	33	35	8	10												
B15		1	51	60	6	10												
W30AAPC00, COZ	460-3	1	9	15	14	14												
C06		1	12	15	14	14												
C09		1	17	20	12	12												
C12		1	21	25	10	10												
C15		1	26	30	10	10												
W36AAPA00, AOZ	230/208-1	1	29	35	8	10												
A05		1	32	35	8	10												
A08		1	47	50	8	10												
A10		1	58	60	6	10												
A15		1 or 2	84	90	4	8	58	26		60	30		6	10		10	10	
W36AAPB00, BOZ	230/208-3	1	23	30	10	10												
B06		1	24	30	10	10												
B09		1	33	35	8	10												
B15		1	51	60	6	10												
W36AAPC00, COZ	460-3	1	11	15	14	14												
C06		1	12	15	14	14												
C09		1	17	20	12	12												
C12		1	21	25	10	10												
C15		1	26	30	10	10												
W42AAPA00, AOZ	230/208-1	1	32	50	8	10												
A05		1	32	50	8	10												
A10		1	58	60	6	10												
A15		1 or 2	84	90	4	8	58	26		60	30		6	10		10	10	
A20		1 or 2	110	125	2	6	58	52		60	60		6	6		10	10	
W42AAPB00, BOZ	230/208-3	1	25	35	8	10												
B06		1	25	35	8	10												
B09		1	33	35	8	10												
B15		1	51	60	6	10												
B18		1	60	60	6	10												
W42AAPC00, COZ	460-3	1	12	15	14	14												
C09		1	17	20	12	12												
C15		1	26	30	10	10												
W48AAPA00, AOZ		230/208-1	1	34	50	8	10											
A05	1		34	50	8	10												
A10	1		58	60	6	10												
A15	1 or 2		84	90	4	8	58	26		60	30		6	10		10	10	
A20	1 or 2		110	125	2	6	58	52		60	60		6	6		10	10	
W48AAPB00, BOZ	230/208-3	1	26	35	8	10												
B06		1	26	35	8	10												
B09		1	33	35	8	10												
B15		1	51	60	6	10												
B18		1	60	60	6	10												
W48AAPC00, COZ	460-3	1	12	15	14	14												
C09		1	17	20	12	12												
C15		1	26	30	10	10												
W48AAPQ00, QOZ	575-3	1	12	15	14	14												
Q15		1	24	25	10	10												
W60AAPA00, AOZ	230/208-1	1	38	60	8	10												
A05		1	38	60	8	10												
A10		1	60	60	6	10												
A15		1 or 2	86	90	3	8	60	26		60	30		6	10		10	10	
A20		1 or 2	112	125	2	6	60	52		60	60		6	6		10	10	
W60AAPB00, BOZ	230/208-3	1	27	40	8	10												
B06		1	27	40	8	10												
B09		1	35	40	8	10												
B15		1	53	60	6	10												
B18		2	N/A	N/A	N/A	N/A	35	28		40	30		8	10		10	10	
W60AAPC00, COZ	460-3	1	14	20	12	12												
C09		1	18	20	12	12												
C15		1	27	30	10	10												
W60AAPQ00, QOZ	575-3	1	13	20	12	12												
Q15		1	24	25	12	12												
W72ABPA00, AOZ	230/208-1	1	58	60	6	10												
A05		1	58	60	6	10												
A10		1 or 2	62	70	6	8	58	26		60	30		6	10		10	10	
A15		1 or 2	88	90	3	8	58	52		60	60		6	6		10	10	
A20		1 or 3	114	125	2	6	58	52	52	60	60	60	6	6	6	10	10	
W72ABPB00, BOZ	230/208-3	1	40	60	8	10												
B06		1	40	60	8	10												
B09		1	40	60	8	10												
B15		1	55	60	6	10												
B18		2	N/A	N/A	N/A	N/A	40	28		60	30		8	10		10	10	
W72ABPC00, COZ	460-3	1	18	25	10	10												
C09		1	18	25	10	10												
C15		1	27	30	10	10												
W72ABPQ00, QOZ	575-3	1	14	20	12	12												
Q15		1	24	25	10	10												

See footnotes under TABLE 2

TABLE 2

Electrical Specifications – W**L*P Series														
MODEL	Rated Volts & Phase	No. Field Power Circuits	Single Circuit				Dual Circuit							
			③ Minimum Circuit Ampacity	① Maximum External Fuse or Ckt. Brkr.	② Field Power Wire Size	② Ground Wire	③ Minimum Circuit Ampacity		① Maximum External Fuse or Ckt. Breaker		② Field Power Wire Size		② Ground Wire Size	
							Ckt. A	Ckt. B	Ckt. A	Ckt. B	Ckt. A	Ckt. B	Ckt. A	Ckt. B
W18LAPA00, A0Z	230/208-1	1	16	20	12	12								
A05		1	30	30	10	10								
A08		1	46	50	8	10								
A10		1	56	60	6	10								
W24LAPA00, A0Z	230/208-1	1	21	30	10	10								
A05		1	30	30	10	10								
A08		1	46	50	8	10								
A10		1	56	60	6	10								
W24LAPB00, B0Z	230/208-3	1	15	20	12	12								
B06		1	22	25	10	10								
W24LAPC00, C0Z	460-3	1	9	15	14	14								
C06		1	11	15	14	14								
W30LAPA00, A0Z	230/208-1	1	26	35	8	10								
A05		1	32	35	8	10								
A08		1	47	50	8	10								
A10		1	58	60	6	10								
A15		1 or 2	84	90	4	8	58	26	60	30	6	10	10	10
W30LAPB00, B0Z		230/208-3	1	19	20	12	12							
B09	1		33	35	8	10								
B15	1		51	60	6	10								
W30LAPC00, C0Z	460-3		1	9	15	14	14							
C09		1	17	20	12	12								
C15		1	26	30	10	10								
W36LAPA00, A0Z	230/208-1	1	29	35	8	10								
A05		1	32	35	8	10								
A10		1	58	60	6	10								
A15		1 or 2	84	90	4	8	58	26	60	30	6	10	10	10
W36LAPB00, B0Z		230/208-3	1	23	30	10	10							
B09	1		33	35	8	10								
B15	1		51	60	6	10								
W36LAPC00, C0Z	460-3	1	11	15	14	14								
C09		1	17	20	12	12								
C15		1	26	30	10	10								
W42LAPA00, A0Z	230/208-1	1	32	50	8	10								
A05		1	32	50	8	10								
A10		1	58	60	6	10								
A15		1 or 2	84	90	4	8	58	26	60	30	6	10	10	10
W42LAPB00, B0Z		230/208-3	1	25	35	8	10							
B06	1		25	35	8	10								
B09	1		33	35	8	10								
B15	1		51	60	6	10								
W42LAPC00, C0Z	460-3	1	12	15	14	14								
C09		1	17	20	12	12								
C15		1	26	30	10	10								
W48LAPA00, A0Z	230/208-1	1	34	50	8	10								
A05		1	34	50	8	10								
A10		1	58	60	6	10								
A15		1 or 2	84	90	4	8	58	26	60	30	6	10	10	10
W48LAPB00, B0Z		230/208-3	1	26	35	8	10							
B06	1		26	35	8	10								
B09	1		33	35	8	10								
B15	1		51	60	6	10								
W48LAPC00, C0Z	460-3	1	12	15	14	14								
C09		1	17	20	12	12								
C15		1	26	30	10	10								
W48LAPQ00, Q0Z	575-3	1	12	15	14	14								
Q15		1	24	25	10	10								
W60LAPA00, A0Z	230/208-1	1	38	60	8	10								
A05		1	38	60	8	10								
A10		1	60	60	6	10								
A15		1 or 2	86	90	3	8	60	26	60	30	6	10	10	10
W60LAPB00, B0Z	230/208-3	1	27	40	8	10								
B06		1	27	40	8	10								
B09		1	35	40	8	10								
B15		1	53	60	6	10								
W60LAPC00, C0Z	460-3	1	14	20	12	12								
C09		1	18	20	12	12								
C15		1	27	30	10	10								
W60LAPQ00, Q0Z	575-3	1	13	20	12	12								
Q15		1	24	25	12	12								
W72LBPA00, A0Z	230/208-1	1	58	60	6	10								
A05		1	58	60	6	10								
A10		1 or 2	62	70	6	8	58	26	60	30	6	10	10	10
A15		1 or 2	88	90	3	8	58	52	60	60	6	6	10	10
W72LBPB00, B0Z	230/208-3	1	40	60	8	10								
B06		1	40	60	8	10								
B09		1	40	60	8	10								
B15		1	55	60	6	10								
W72LBPC00, C0Z	460-3	1	18	25	10	10								
C09		1	18	25	10	10								
C15		1	27	30	10	10								
W72LBPQ00, Q0Z	575-3	1	14	20	12	12								
Q15		1	24	25	10	10								

① Maximum size of the time delay fuse or circuit breaker for protection of field wiring conductors.

② Based on 75°C copper wire. All wiring must conform to the National Electrical Code and all local codes.

③ These "Minimum Circuit Ampacity" values are to be used for sizing the field power conductors. Refer to the National Electrical code (latest version), Article 310 for power conductor sizing.

CAUTION: When more than one field power circuit is run through one conduit, the conductors must be derated. Pay special attention to Note 8 of Table 310 regarding Ampacity Adjustment Factors when more than three current carrying conductors are in a raceway.

IMPORTANT: While this electrical data is presented as a guide, it is important to electrically connect properly sized fuses and conductor wires in accordance with the National Electrical Code and all local codes.

TABLE 3

Electrical Specifications – W**A*E Series																		
Model	Rated Volts & Phase	No. Field Power Circuits	Single Circuit				Dual Circuit											
			① Minimum Circuit Ampacity	② Maximum External Fuse or Ckt. Brkr.	③ Field Power Wire Size	④ Ground Wire	① Minimum Circuit Ampacity			② Maximum External Fuse or Ckt. Breaker			③ Field Power Wire Size			④ Ground Wire Size		
							Ckt. A	Ckt. B	Ckt. C	Ckt. A	Ckt. B	Ckt. C	Ckt. A	Ckt. B	Ckt. C	Ckt. A	Ckt. B	Ckt. C
W36AAEA15	230/208-1	1 or 2	104	110	2	6	52	52		60	60		6	6		10	10	
W36AAEB15	230/208-3	1 or 2	66	70	4	8	21	48		30	50		10	8		10	10	
W36AAEC15	460-3	1	34	35	8	10												
W48AAEA15	230/208-1	1 or 2	110	110	2	6	58	52		60	60		6	6		10	10	
W48AAEB15	230/208-3	1 or 2	69	70	4	8	24	49		30	50		10	8		10	10	
W48AAEC15	460-3	1	34	35	8	10												
W60AAEA15	230/208-1	1 or 3	114	120	2	6	36	52	52	40	60	60	8	6	6	10	10	10
W60AAEB15	230/208-3	1 or 2	72	80	4	8	26	50		30	50		10	8		10	10	
W60AAEC15	460-3	1	36	40	8	10												
W72ABEA15	230/208-1	1 or 3	134	140	1/0	6	58	52	26	60	60	30	6	6	10	10	10	10
W72ABEB15	230/208-3	1 or 2	83	90	4	8	38	52		40	60		8	6		10	10	
W72ABEC15	460-3	1	40	45	8	10												

① These “Minimum Circuit Ampacity” values are to be used for sizing the field power conductors. Refer to the National Electrical code (latest version), Article 310 for power conductor sizing.

② Maximum size of the time delay fuse or circuit breaker for protection of field wiring conductors.

③ Based on 75°C copper wire. All wiring must conform to the National Electrical Code and all local codes.

CAUTION: When more than one field power circuit is run through one conduit, the conductors must be derated. Pay special attention to note 8 of Table 310 regarding Ampacity Adjustment Factors when more than three (3) current carrying conductors are in a raceway.

IMPORTANT: While this electrical data is presented as a guide, it is important to electrically connect properly sized fuses and conductor wires in accordance with the National Electrical Code and all local codes.

Running in Stand Orphan Mode

With the AC breakers turned on, each MULTI-TEC wall-mount unit has the capability to run without the LC6000 controller or th-TUNE connected—this feature is called orphan mode. This keeps the shelter between 60°F and 77°F (factory default settings) by the use of the factory-installed return air sensor in each wall-mount unit. In orphan mode, the wall unit uses a continuous blower setting to circulate room air into the return air inlet and uses the return air temperature sensor to control room temperature.

The wall-mount unit can be turned on and off with the TEC-EYE hand-held diagnostic tool. When ON is chosen, the wall-mount unit will heat or cool. When set to OFF using the TEC-EYE, the wall-mount unit will not heat, cool or ventilate.

To turn the unit on or off with TEC-EYE:

1. Connect the TEC-EYE diagnostic tool to the control board located in the unit.
2. Press MENU key to go to the Main Menu screen.
3. Press UP or DOWN keys and ENTER key to enter USER password 2000.
4. Press UP or DOWN keys to scroll to **On/Off**; press ENTER key.
5. Press UP or DOWN keys to change value from On to Off or from Off to On.
6. Press ESCAPE key several times to return to Main Menu screen.

To verify or change the wall-mount unit cooling and heating setpoints in orphan mode:

1. Connect the TEC-EYE diagnostic tool to the control board located in the unit.
2. From the Status screen, press UP or DOWN key until Quick Menu displays Setpoints (SET) icon. Press ENTER key.
3. Press ENTER key to scroll to the selected choice (see Figure 11).
4. Press UP or DOWN key on desired value until value displays correctly.
5. Press ENTER key to save and scroll to next parameter.
6. Press ESCAPE key until Main Menu screen is displayed.

FIGURE 11
Cooling and Heating Setpoints

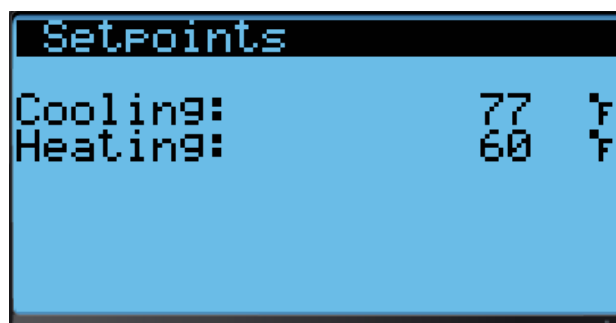

During installation, the ability to run in orphan mode allows deactivation of one of the existing, older wall-mount units, while keeping the shelter cool with the other unit still operating. Once the first of the Bard MULTI-TEC wall-mount units is installed, orphan mode can be enabled early in the installation—keeping the climate inside the shelter stable and the installers comfortable while the remainder of the older equipment is removed and the remaining Bard MULTI-TEC wall-mount units and LC6000 controller are installed.

Additionally, should any or all of the MULTI-TEC wall-mount units lose communication with the LC6000 controller (such as during maintenance), they will continue to serve the shelter's needs until a repair can be made.

NOTE: Screenshots shown in this manual reflect default settings (when applicable).

LC6000 CONTROLLER INSTALLATION

FIGURE 12
Typical LC6000-200 Component Location

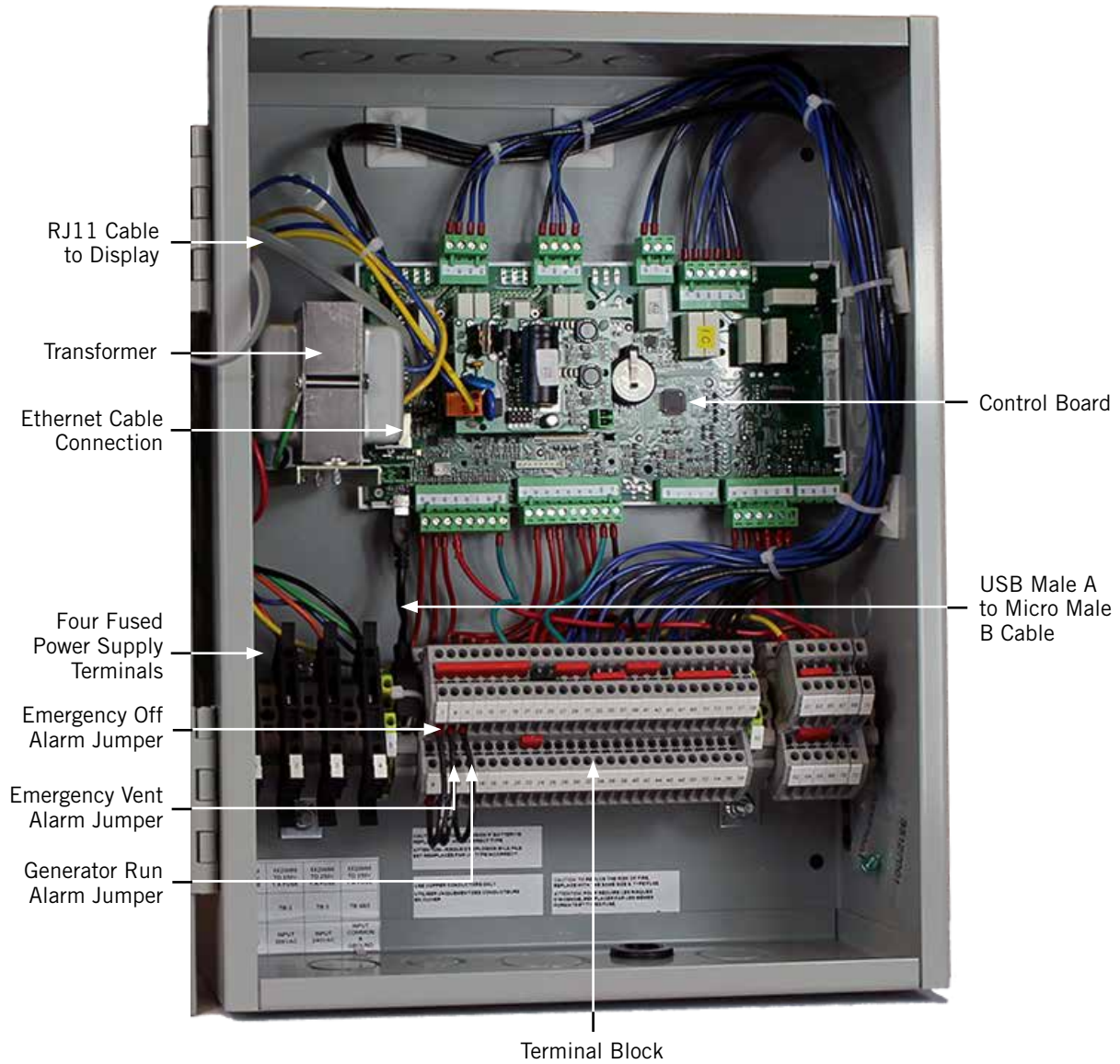

WARNING

Electrical shock hazard.

Disconnect VAC power supplies before servicing.

Failure to do so could result in electric shock or death.

IMPORTANT: When working with circuit board components, Bard recommends the use of an anti-static wrist strap to prevent static electricity shorts to electronic controls.

LC6000 Controller

The LC6000 controller is part of this air conditioning system. It is used to control up to 14 wall-mount air conditioners from one controller. The microprocessor control provides an easy-to-read interface with large LCD graphical display. It provides control for redundancy for the structure and equal wear on all units.

Conduit is recommended for all wiring. Route communication wiring and power supply wiring in their own separate conduits.

The LC6000 controller is not weatherproof and is intended for use in a weathertight structure.

Mounting the LC6000 Controller

The dimensions of the LC controller are 16" x 12" x 6".

Because the LC6000 controller utilizes a remote temperature sensor as opposed to one located in the controller box, the controller itself can be installed in any indoor location that is suitable, preferably at eye level. Four (4) mounting holes are provided for mounting to the wall and holes for conduit connections are provided in the base, sides and top of the controller.

The LC6000 controller includes four fused power supply terminals in the terminal block. Before connecting wires to the terminal block, confirm that the fuse in each of the four fuse holders is in the proper position (active) as shown in Figure 13.

FIGURE 13
LC6000 Fused Power Supply Terminal

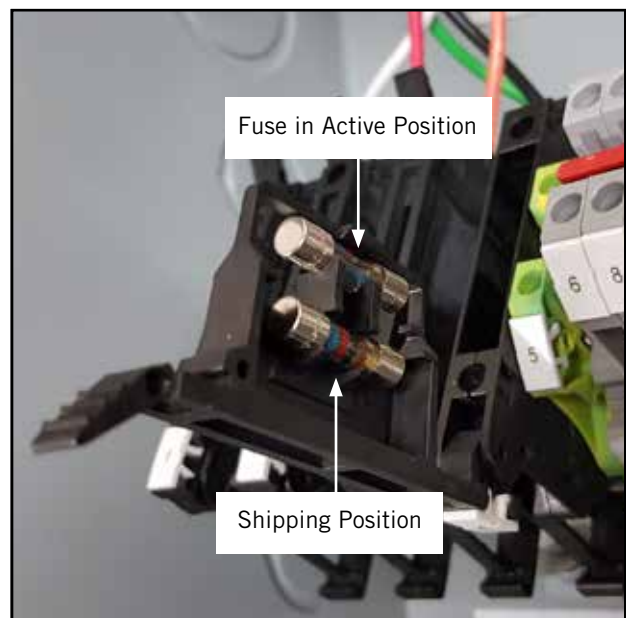
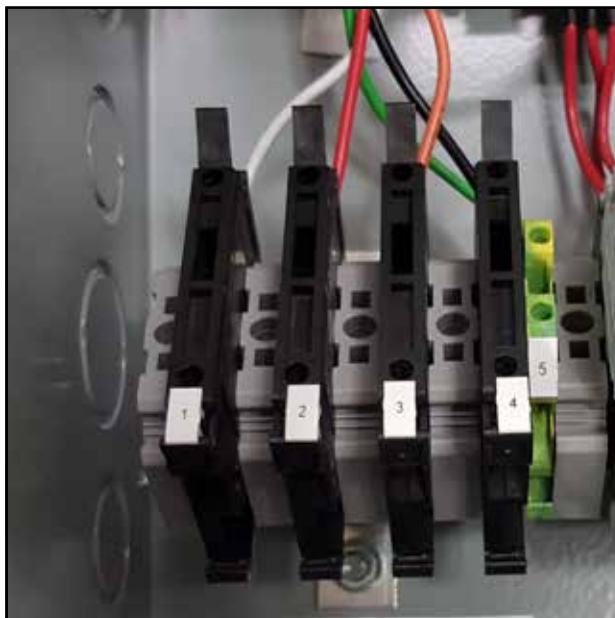

Installing Remote Indoor Temperature/Humidity Sensor(s)

One remote indoor temperature/humidity sensor and 35' of 18 gauge 5-conductor shielded cable is included with the controller. This sensor must be installed for proper operation. Mount the temperature/humidity sensor in a location least likely to be affected by open doors, rack-mounted fans, radiant heat sources, etc. Locating the sensor between both return grilles is often the best location, but every installation is unique. Location height should be approximately 60" above the floor. The sensor should be installed on a 2" x 4" junction box to allow for control wire conduit. Use shielded cable to connect to controller.

FIGURE 14
Remote Indoor Temperature/Humidity Sensor Installation

1. Connect wires from the 18 gauge shielded cable to terminals #12, #13, #18, #19 and #22.

TB#	Wire Mark	Sensor	Description
18	B6	NTC OUT	Indoor Remote Sensor (Zone 1)
19	GND	NTC OUT	Ground
12	B2	OUT H	Remote Indoor Humidity Sensor: 0-1 VDC (Zone 1)
13	GND	M (GO)	Ground
22	+VDC	+ (G)	Power for B2

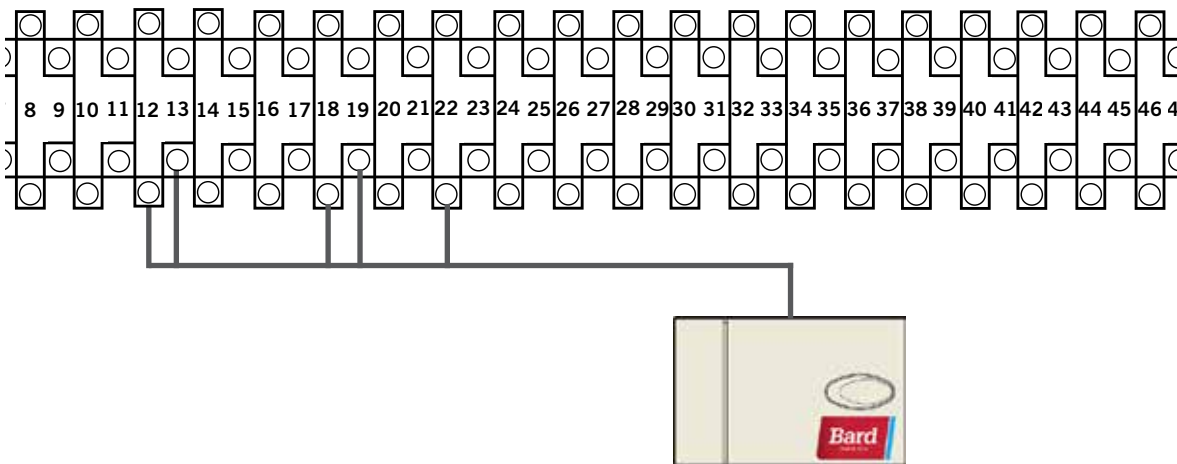

2. Connect the other end of the shielded cable to the sensor terminals. Be sure wires are connected to proper terminals as shown in table above.

Sensor jumpers need to be positioned for 0-1 V. With sensor oriented as shown in image to right, move both jumpers to left position (DP1 and DP2 set to OFF). **This applies to all temperature/humidity sensors connected to the LC controller.**

Sensor is best mounted on a junction box, and it is recommended that the cable be in conduit.

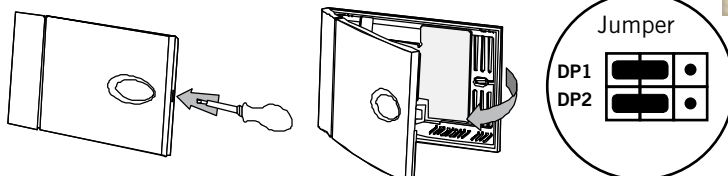

For proper operation, the remote indoor temperature/humidity sensor (and any additional sensors) must be configured properly with the controller as shown in Step 2 on page 24. An additional remote indoor temperature-only sensor can be purchased and installed in Zone 1. If the site in which the LC6000 controller will be used has more than one zone (maximum three zones per LC6000), additional remote temperature/humidity sensors (one per zone) will need to be purchased and installed in the additional zones. All installed sensors must be enabled in the controller menu (see **Configure Sensors** beginning on page 39).

FIGURE 15
Additional Remote Temperature and Temperature/Humidity Sensor Installation

One additional temperature sensor can be added to Zone 1 and additional temperature/humidity sensors may be added to Zones 2 and 3 (one per zone). **Be sure the sensors are connected to the proper terminals on the terminal block and sensor as listed below.**



Zone 1:
 Optional Remote Temperature Sensor
Terminals 20 & 21*

TB#	Wire Mark	Description
20	B7	Indoor Remote Sensor (Zone 1 – optional)
21	GND	Ground

* The two wire connections for the optional remote temperature sensor are not polarity sensitive.



Zone 2:
 Optional Remote Temperature/Humidity Sensor
Terminals 26, 27, 14, 15 & 23

IMPORTANT: Note jumper position in Figure 14

TB#	Wire Mark	Sensor	Description
26	B8	NTC OUT	Indoor Remote Sensor (Zone 2)
27	GND	NTC OUT	Ground
14	B3	OUT H	Remote Indoor Humidity Sensor: 0-1 VDC (Zone 2)
15	GND	M (GO)	Ground
23	+VDC	+ (G)	Power for B3



Zone 3:
 Optional Remote Temperature/Humidity Sensor
Terminals 28, 29, 16, 17 & 24

IMPORTANT: Note jumper position in Figure 14

TB#	Wire Mark	Sensor	Description
28	B9	NTC OUT	Indoor Remote Sensor (Zone 3)
29	GND	NTC OUT	Ground
16	B4	OUT H	Remote Indoor Humidity Sensor: 0-1 VDC (Zone 3)
17	GND	M (GO)	Ground
24	+VDC	+ (G)	Power for B4

Zones 2 and 3 can also use temperature-only sensors in place of the temperature/humidity sensors. Zone 2 will connect to TB# 26 and 27. Zone 3 will connect to TB# 28 and 29. The wire connections for the temperature-only sensors are not polarity sensitive.

Installing Optional Outdoor Temperature/Humidity Sensor

One optional outdoor temperature/humidity sensor (8301-090) can be installed. Follow the manufacturer's mounting instructions. Use 18 gauge 5-conductor shielded cable to connect to controller.

FIGURE 16
Remote Outside Temperature/Humidity Sensor Installation

1. Connect wires from the 18 gauge shielded cable to terminals #65, #66, #67, #70 and #71.

TB#	Wire Mark	Sensor	Description
70	B12	4	Remote Outdoor Temperature Sensor
71	ND	5	Ground
67	B11	1	Remote Outdoor Humidity Sensor: 0-10 VDC
66	GND	3	Ground
65	+VDC	2	+VDC

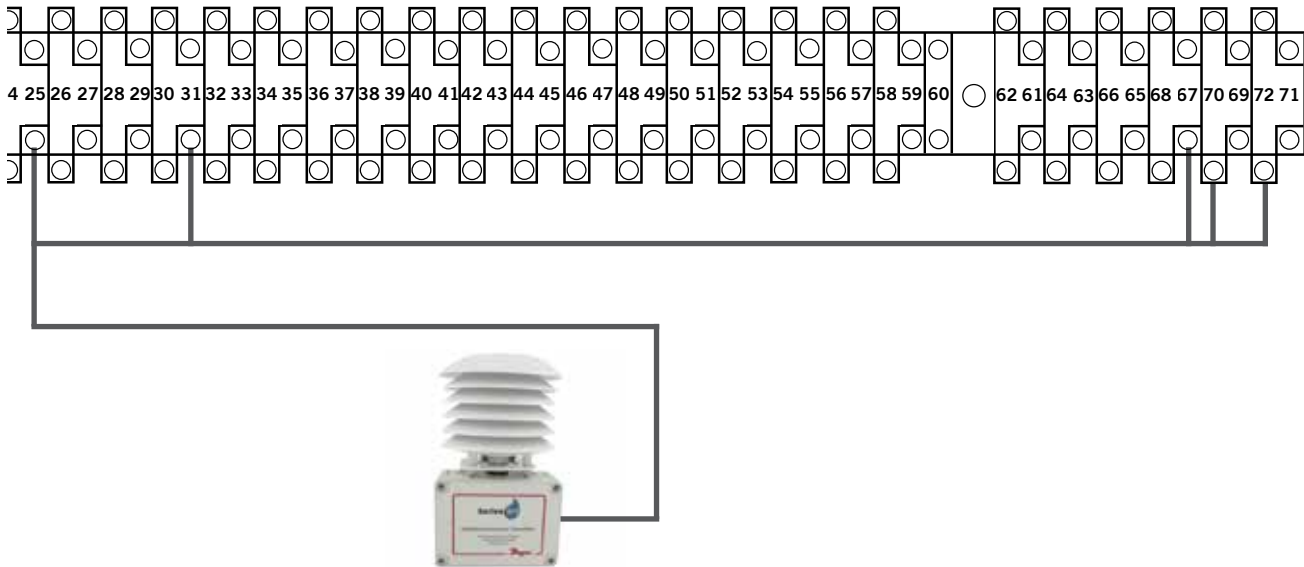

2. Connect the other end of the shielded cable to the sensor terminals. Be sure wires are connected to proper terminals as shown in table above.

Emergency Off, Emergency Ventilation and Generator Run Connections

The LC6000-200 controller is shipped with emergency off, emergency ventilation and generator run contacts. There are factory-installed jumpers across terminals #6 and #7 (emergency off), #8 and #9 (emergency ventilation) and #10 and #11 (generator run). Remove the factory-installed jumpers before making the connections.

FIGURE 17

LC6000-200 Series Connection for Emergency Off, Emergency Ventilation and Generator Run (If Applicable)

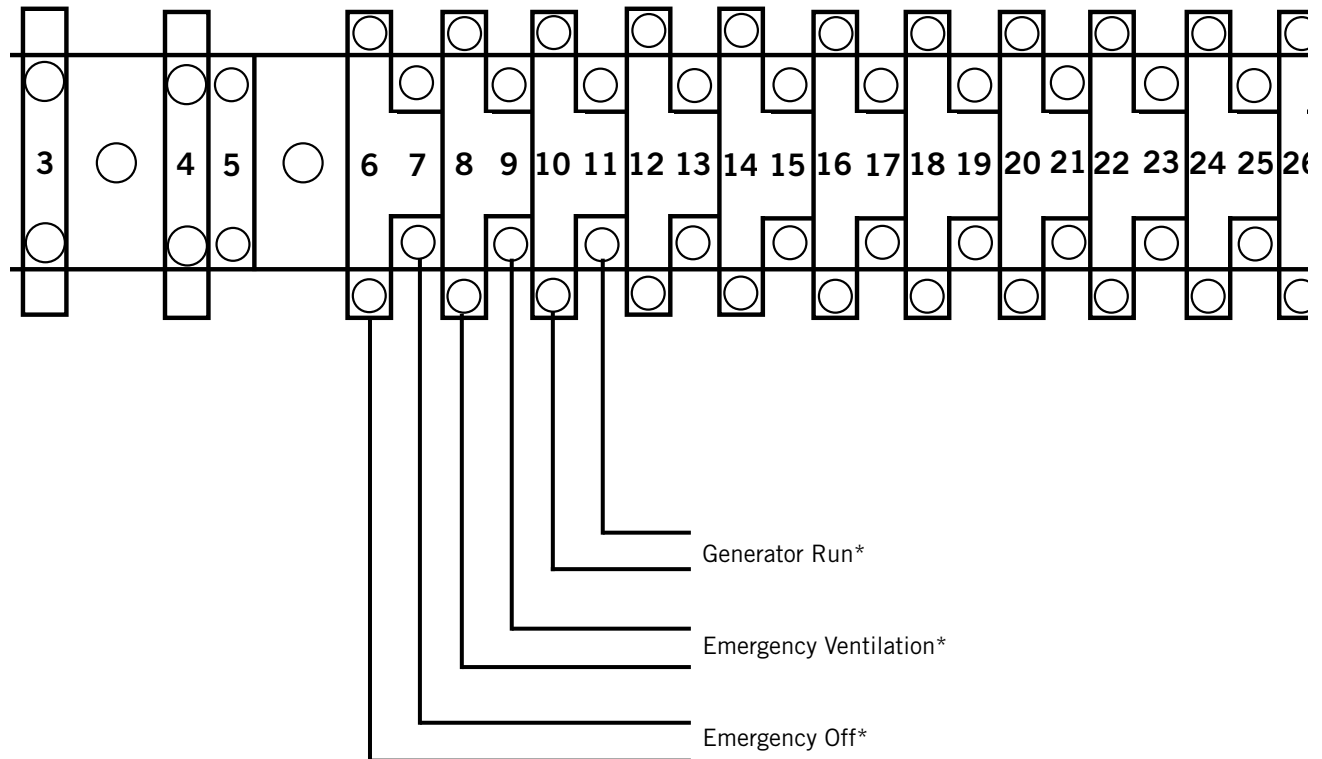

* Normally closed (NC) contacts required.

By default:
 Closed = No Alarm
 Open = Alarm

Communication Wiring

Connect the communication wiring from the wall-mount units to the controller in the manner shown in Figures 18, 19 or 20. **The daisy chain does not need to follow the addressing order.** The communication wire should be 2-wire, 18 gauge shielded cable with drain. Any color can be used. Be sure to match "+" and "-" symbols on controller terminal blocks to prewired unit control terminal block (see Figures 22 and 23 on pages 31 and 32). Attach communication wire filters as shown in Figures 18, 19 or 20. **Do not run communication wiring in same conduit as supply wiring. Route communication wiring and power supply wiring in their own separate conduits.**

FIGURE 18
Communication Wiring (Daisy Chain Method)

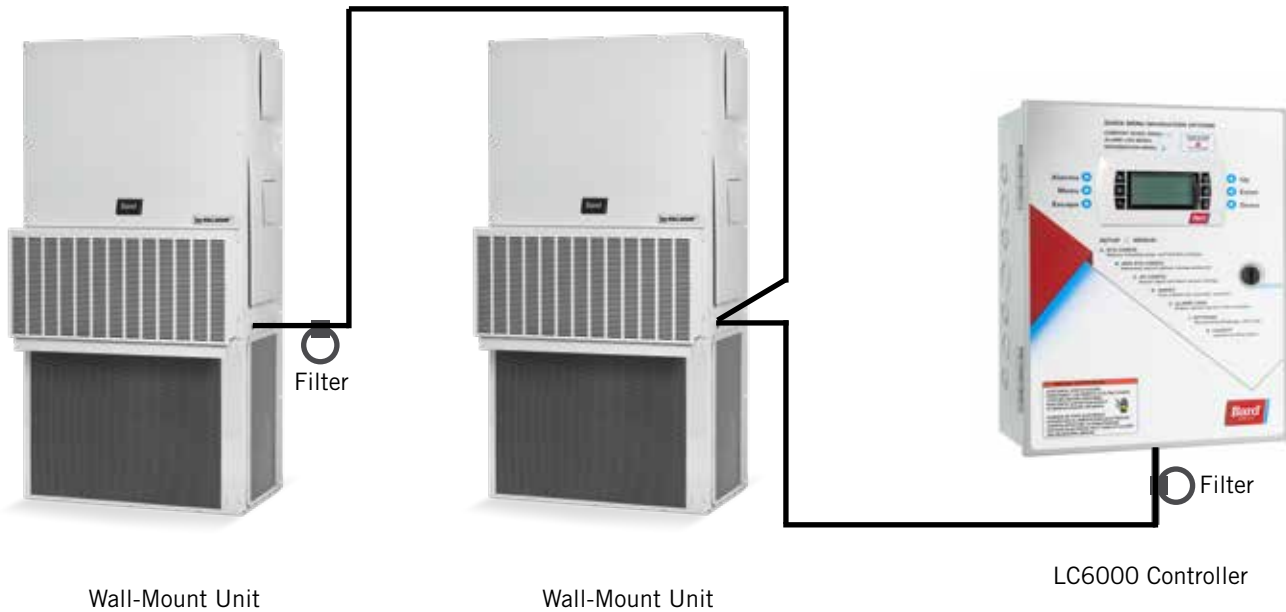

In addition to the "daisy chain" method of connecting the communication wiring shown in Figure 18, the wall-mount units can also be connected in the manner shown in Figure 19. If connecting wall-units this way, be sure to place the communication wire filters in the positions shown in Figure 19. See Figure 20 for more information on the correct placement of the communication wire filters depending on the wiring method used.

FIGURE 19
Communication Wiring (Alternate Method)

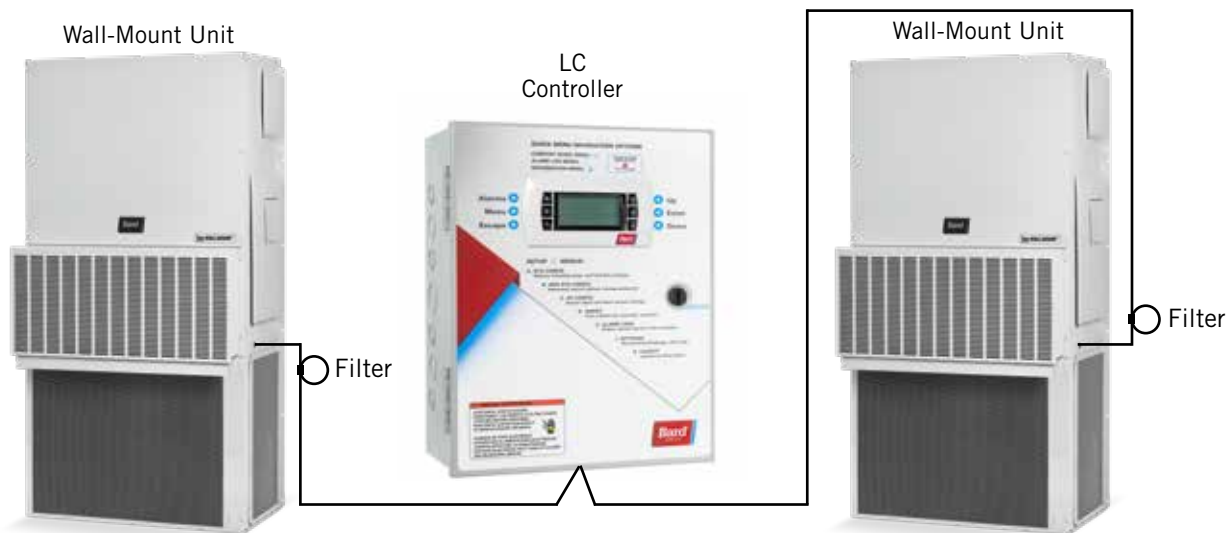

The steps outlined on the following pages show how to connect the communication wiring using the daisy chain method shown in Figure 18. If using the alternate method (as shown in Figure 19), the connections to the controller and each wall-mount unit will be the same but the filters need to be placed in the positions shown in Figure 20.

FIGURE 21
Communication Wiring: Termination at the Controller

1. Using the field-provided shielded cable, make a small service loop after entering the controller and attach the provided EMI filter at the intersection of the loop.

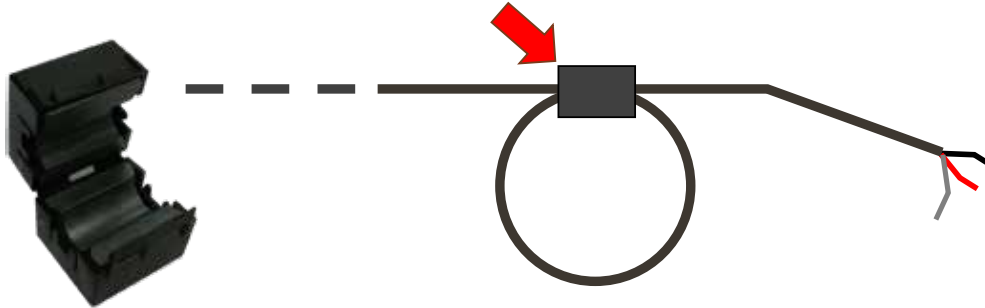

2. Connect one wire to terminal #56 (negative), the other wire to terminal #57 (positive) and the drain wire to ground terminal #60.

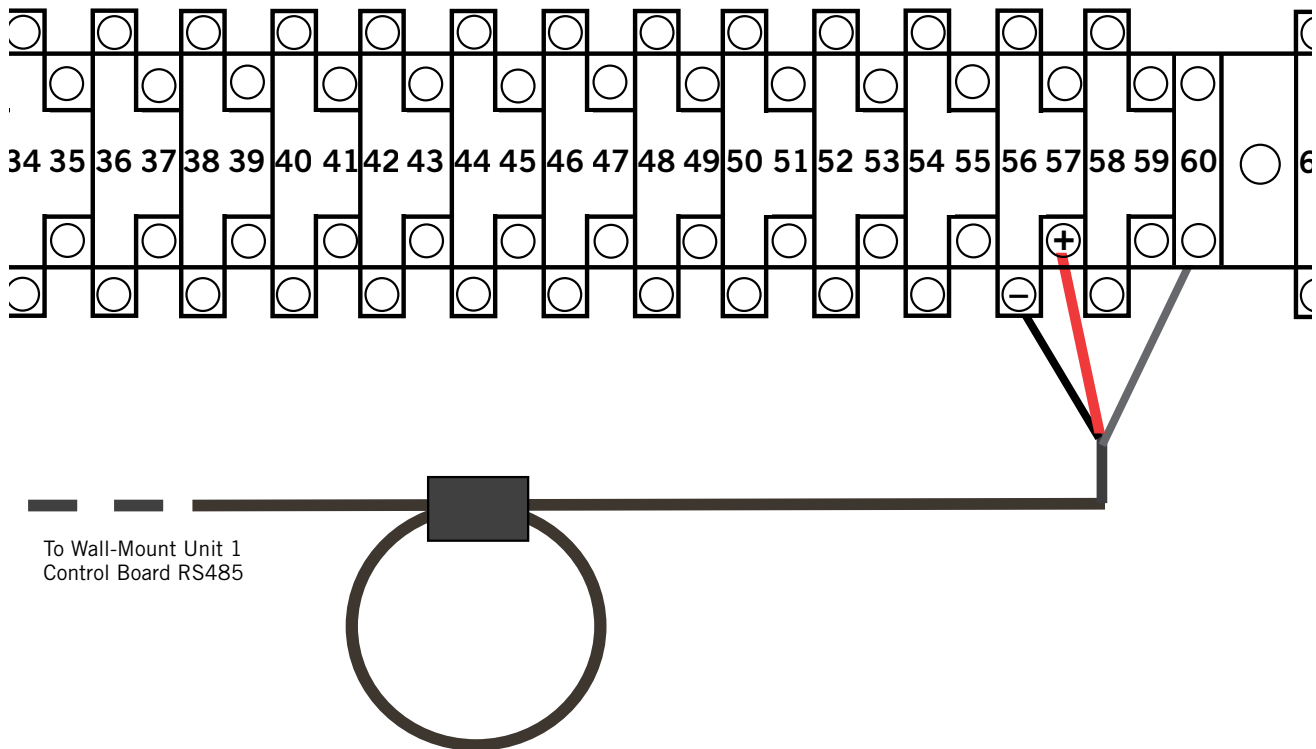
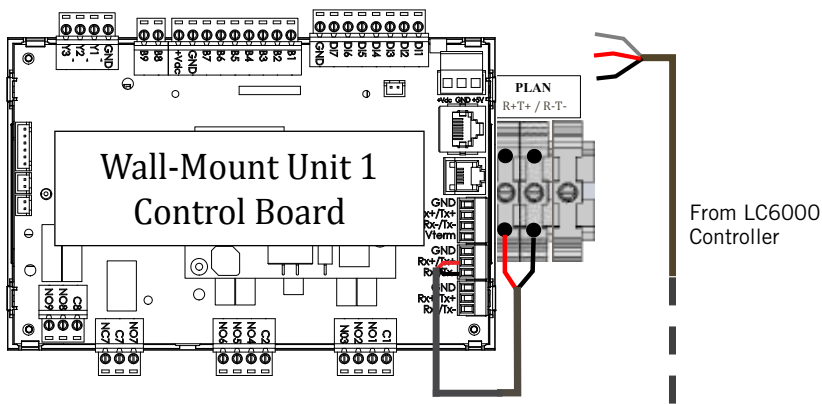
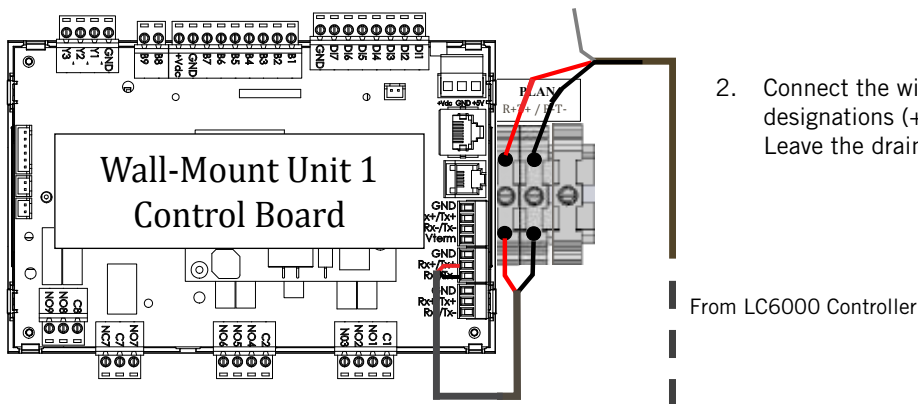

FIGURE 22
Communication Wiring: Termination at the First Wall-Mount Unit



1. From the controller, extend the shielded cable through a separate conduit and route to the provided terminal block next to the wall-mount control board.

Note that the terminal block label is clearly marked “+” and “-”. These connections are polarity-sensitive. Two-wire communication from control board is prewired to terminal block. Make sure to match “+” and “-” symbols on controller terminal blocks.



2. Connect the wires matching the terminal designations (+/-) of the controller terminals. Leave the drain wire loose.

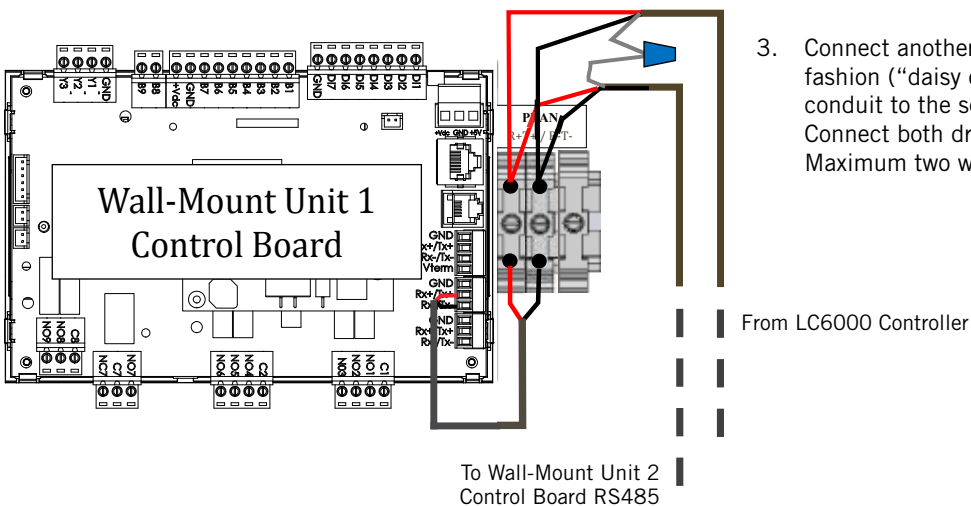

3. Connect another cable in a similar fashion (“daisy chain”) to route in conduit to the second wall-mount unit. Connect both drain wires with wire nut. Maximum two wires per terminal.

FIGURE 23
Communication Wiring: Termination at Additional Wall-Mount Units

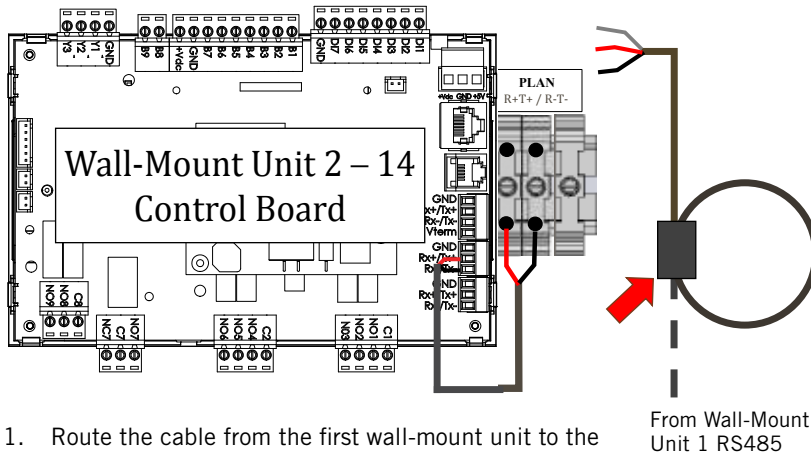

1. Route the cable from the first wall-mount unit to the terminal block of the second wall-mount unit. If this is the last unit to be connected, make a small service loop and attach EMI filter as shown.

From Wall-Mount Unit 1 RS485

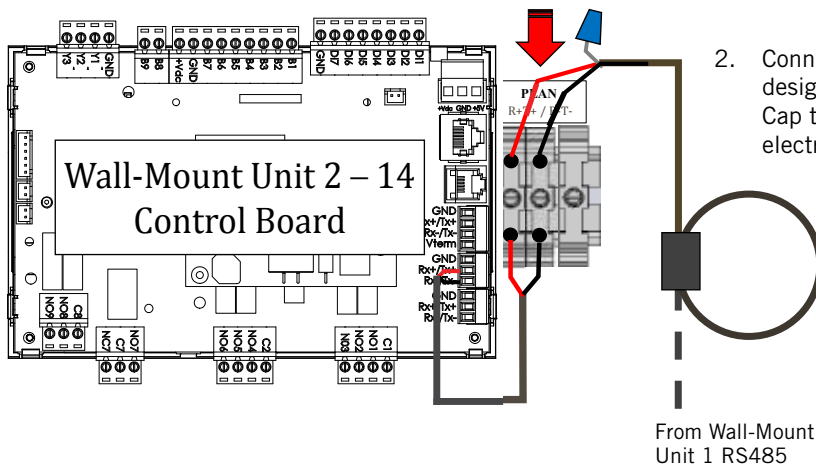

2. Connect the wires matching the terminal designations (+/-) of the controller terminals. Cap the loose drain with a wire nut or electrical tape.

From Wall-Mount Unit 1 RS485

3. Continue daisy chaining units by connecting "+" to "+", "-" to "-" and wire nutting drain together until last unit which is capped with a wire nut. Attach EMI filter as shown above at last unit. Up to 14 wall-mount units can be connected and controlled by one LC6000 controller.

Supply Wiring

The LC6000 controller is powered by 120, 208 or 240 volts from the shelter. Field-supplied supply wiring should be minimum 16 gauge, maximum 14 gauge (see Figure 24). A reliable earth ground must be connected in addition to any grounding from conduit. Grounding bolts and nuts are included with the controller for this purpose; a 2 hole grounding lug must be field supplied. Install as shown in Figure 25. **Failing to ground the controller box properly could result in damage to the equipment.**

FIGURE 24
LC6000 Controller Circuit Install

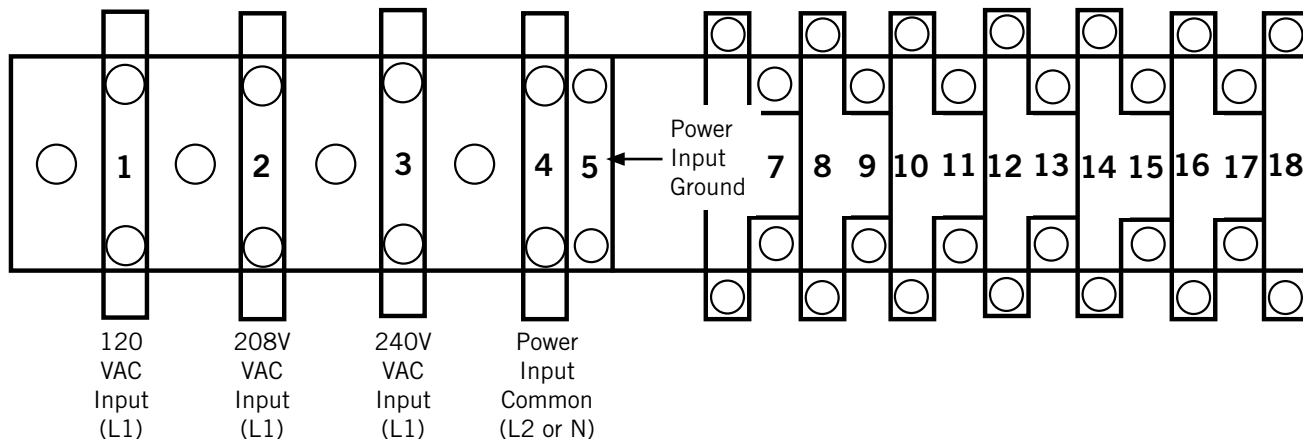

FIGURE 25
Controller Grounding Posts

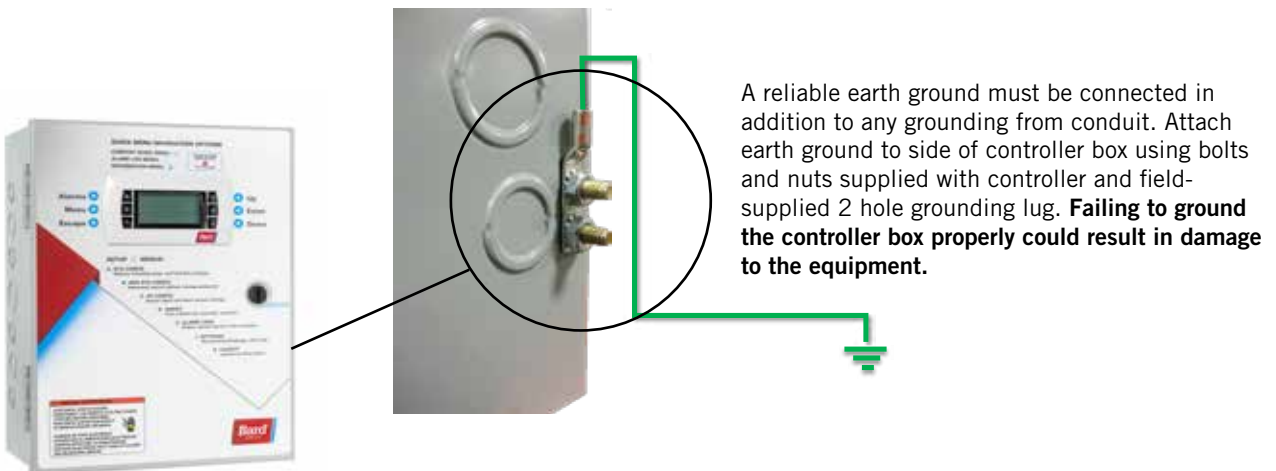
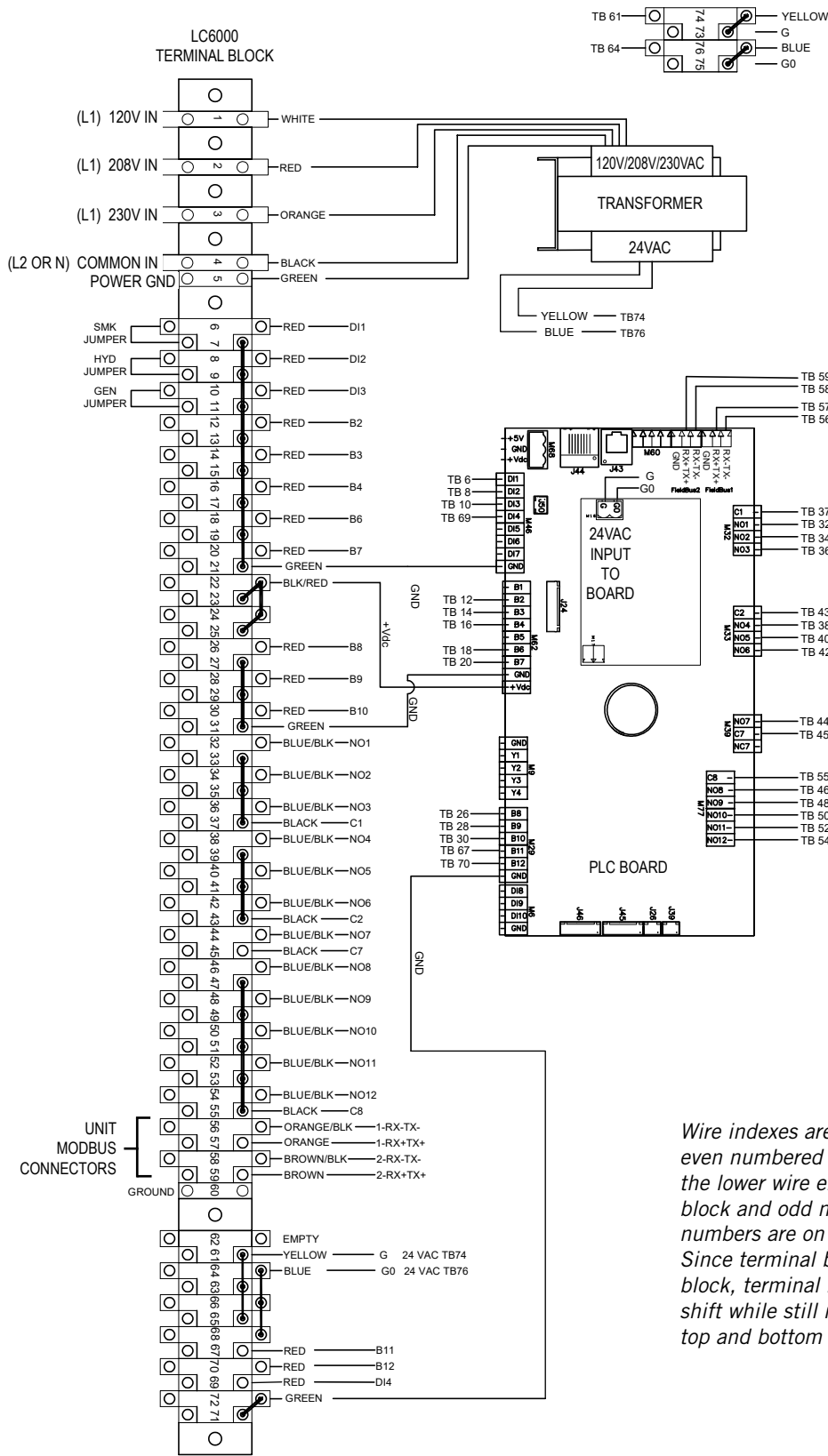

TABLE 4
LC6000-200 Terminal Block Index

TB#	Wire Mark	Description
1	-	120 VAC Input
2	-	208 VAC Input
3	-	230 VAC Input
4	-	Power Input Common
5	-	Power Input Ground
6	DI1	Emergency Off Input
7	GND	Emergency Off Common
8	DI2	Emergency Vent Input
9	GND	Emergency Vent Common
10	DI3	Generator Run Input
11	GND	Generator Run Common
12	B2	Zone 1 Indoor Remote Humidity Sensor
13	GND	Ground
14	B3	Zone 2 Indoor Remote Humidity Sensor
15	GND	Ground
16	B4	Zone 3 Indoor Remote Humidity Sensor
17	GND	Ground
18	B6	Zone 1 Indoor Temperature Sensor
19	GND	Ground
20	B7	Zone 1 Indoor Remote Temperature Sensor
21	GND	Ground
22	VDC+	Power for B2 (Z1 Humidity)
23	VDC+	Power for B3 (Z2 Humidity)
24	VDC+	Power for B4 (Z3 Humidity)
25	VDC+	Power for B10 (Pressure)
26	B8	Zone 2 Indoor Remote Temperature Sensor
27	GND	Ground
28	B9	Zone 3 Indoor Remote Temperature Sensor
29	GND	Ground
30	B10	Indoor Space Pressure
31	GND	Ground
32	NO1	Humidifier 1
33	C1	Common
34	NO2	Humidifier 2
35	C1	Common
36	NO3	Humidifier 3
37	C1	Common
38	NO4	Emergency Off Alarm

TB#	Wire Mark	Description
39	C2	Common
40	NO5	Emergency Vent Alarm
41	C2	Common
42	NO6	Generator Run Alarm
43	C2	Common
44	NO7	Indoor Humidity Alarm
45	C7	Common
46	NO8	High Indoor Temperature Alarm
47	C8	Common
48	NO9	Low Indoor Temperature Alarm
49	C8	Common
50	NO10	Zone 1 Unit Alarm
51	C8	Common
52	NO11	Zone 2 Unit Alarm
53	C8	Common
54	NO12	Zone 3 Unit Alarm
55	C8	Common
56	FB1R-	RS485 RX- / TX- (Fieldbus 1) UNIT CONNECTION
57	FB1R+	RS485 RX+ / TX+ (Fieldbus 1) UNIT CONNECTION
58	FB2R-	RS485 RX- / TX- (Fieldbus 2)
59	FB2R+	RS485 RX+ / TX+ (Fieldbus 2)
60	--	Power Input Ground
61	24 VAC+	24 VAC Supply
62	--	Not Used
63	24 VAC+	24 VAC Supply
64	24 VAC-	24 VAC Ground
65	24 VAC+	24 VAC Supply for Outdoor Humidity Sensor
66	24 VAC-	24 VAC Ground for Outdoor Humidity Sensor
67	B11	Signal for Outdoor Humidity Sensor
68	24 VAC+	24 VAC Supply
69	D14	Bard Guard Alarm Signal
70	B12	Signal for Outdoor Temperature Sensor
71	GND	Ground for Outdoor Temperature Sensor
72	GND	Ground for Bard Guard Alarm Signal
73	G	Orange Power Connector
74	24 VAC+	24 VAC Supply
75	GO	Orange Power Connector
76	24 VAC-	24 VAC Ground

FIGURE 26
LC6000-200 Wiring Diagram



NOTE:

Wire indexes are identified such that even numbered index numbers are on the lower wire entries of the terminal block and odd numbered index numbers are on the top wire entries. Since terminal block 60 is a ground block, terminal blocks 61 thru 72 shift while still maintaining the same top and bottom configuration.

SYSTEM SET UP

NOTE: Screenshots shown in this manual reflect default settings (when applicable).

The LC6000 controller and TEC-EYE hand-held diagnostic tool will both be used to set up the Bard air conditioning system (the TEC-EYE is only used to set up the wall-mount units).

TABLE 5
LC6000/TEC-EYE Passwords (Defaults)

User	2000
Technician	1313
Engineer	9254
Use UP or DOWN keys and ENTER key to enter password	

TEC-EYE Hand-Held Diagnostic Tool

The microprocessor control used in the MULTI-TEC wall-mount air conditioners allows for complete control and monitoring through the use of the provided TEC-EYE hand-held monitor.

The menu driven interface provides users the ability to scroll through two menu levels: Quick Menu and Main Menu. The menus permit the user to easily view, control and configure the unit. See the latest version of MULTI-TEC Service Manual 2100-665 for more information on using the TEC-EYE.

The TEC-EYE connects to the wall-mount unit control board via an RJ11 modular connector as shown in Figure 27.

When not being used, the TEC-EYE hand-held diagnostic tool should be stored inside or near the LC6000 controller. Do not let the TEC-EYE leave the shelter.

FIGURE 27
TEC-EYE Connection to Unit Control

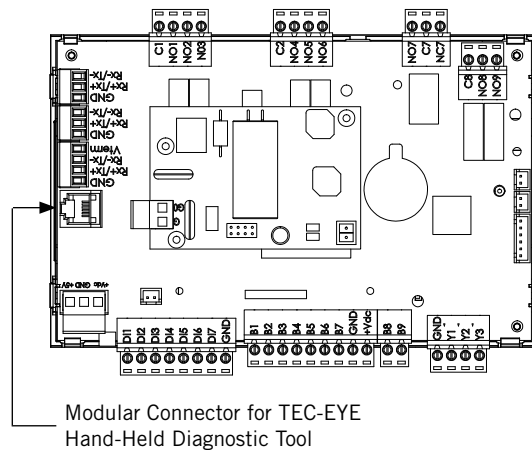

FIGURE 28
TEC-EYE (Bard P/N 8301-059) Display and Interface (Status Screen Shown)



ALARM KEY

Allows viewing of active alarms
Silences audible alarms
Resets active alarms

MENU KEY

Allows entry to Main Menu

ESCAPE KEY

Returns to previous menu level
Cancels a changed entry

UP KEY

Steps to next screen in the display menu
Changes (increases) the value of a modifiable field

ENTER KEY

Accepts current value of a modifiable field
Advances cursor

DOWN KEY

Steps back to previous screen in the display menu
Changes (decreases) the value of a modifiable field

TEC-EYE Status Screen

The Status screen is the default start-up screen and also the return screen after 5 minutes of no activity. The screen can be accessed any time by pressing the ESCAPE key repeatedly.

The wall-mount unit address is displayed in the upper right corner on the Status screen (see Figure 28). The Status screen also shows the current date, time, return air temperature, mixed air temperature, outdoor air temperature, outdoor humidity and outdoor dew point conditions. Blower, damper and unit status are also displayed. See Table 6 on page 45 for wall-mount unit status messages.

NOTICE

It is important to check the software version during installation to ensure that the latest version has been installed. Current software versions, change log and installation instructions are available on the Bard website at <http://www.bardhvac.com/software-download/>

Setting Up Wall-Mount Units for Operation

The TEC-EYE hand-held diagnostic tool is needed to set up the wall-mount unit(s).

1. Address Each Wall-Mount Unit

Each unit must have a unique address for the system to operate correctly with the LC controller (Ex: 1, 2, 3, ...14 depending on the number of units). The unit only needs the address to be changed for the communication to work properly. The wall-mount unit address is displayed in the upper right corner on the Status screen on the TEC-EYE display (see Figure 28).

To change the unit address:

- 1) Press MENU key to access the Main Menu screen.
- 2) Press UP or DOWN keys and ENTER key to enter USER password 2000.
- 3) Press UP or DOWN keys to scroll to **Sys Config**; press ENTER key.
- 4) Press ENTER key to scroll to **Unit Address** (see Figure 29).
- 5) Press UP or DOWN keys to change the address to a value between 1 and 14.

NOTE: Each unit must have a unique address for the communication to work properly. Bard also

recommends physically labeling each unit for ease in identification.

FIGURE 29
Unit Configuration

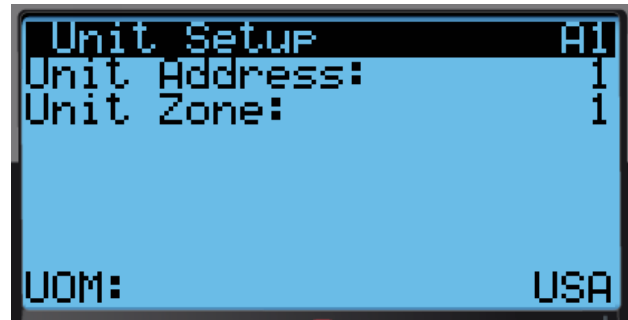

In addition to setting up the address, the user may also want to set the unit zone and unit of measure. Unit addresses can only be used once per LC6000 regardless of number of zones.

To change these settings:

- 1) Press MENU key to access the Main Menu screen.
- 2) Press UP or DOWN keys and ENTER key to enter USER password 2000.
- 3) Press UP or DOWN keys to scroll to **Sys Config**; press ENTER key.
- 4) Press ENTER key to scroll to **Unit Zone** (see Figure 29).
- 5) If desired, press UP or DOWN keys to change value to desired zone.
- 6) Press ENTER scroll to **UOM**.
- 7) If desired, press UP or DOWN keys to change the value from **USA** to **SI, NC, LON, CAN** or **UK**. Units are preconfigured for each selection.
- 8) Press ENTER key to save.

Basic wall unit parameter settings are now set and the unit is ready to communicate with the LC.

2. Execute a Run Test on Each Unit

Execute a run test on each unit to verify the equipment is functioning correctly. The run test parameters are not adjustable.

- 1) Press MENU key to access the Main Menu screen.
- 2) Press UP or DOWN keys and ENTER key to enter USER password 2000.
- 3) Press UP or DOWN keys to scroll to **Sys Config**; press ENTER key.
- 4) Press UP or DOWN keys to scroll to **Run Test A11** screen.

- 5) Press ENTER key to scroll to **Run Test Enable** parameter (see Figure 30).
- 6) Press UP or DOWN key to change value to **ON**. The run test will begin.

FIGURE 30
Executing Run Test

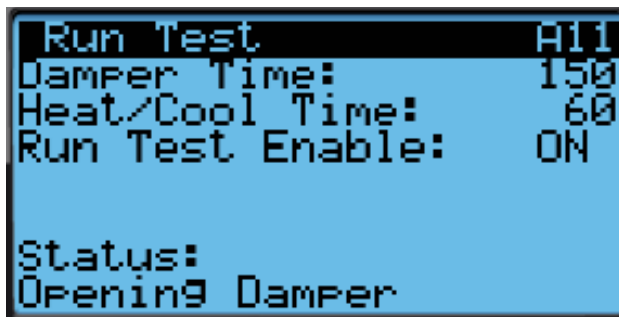

Step	Action	Time Required
A	Open economizer damper	Damper Time (150s)
B	Close economizer Damper	Damper Time (150s)
C	Turn on compressor	Heat/Cool Time (60s)
D	Enable second stage	Heat/Cool Time (60s)
E	Open reheat valve	Heat/Cool Time (60s)
F	Turn all cooling off	--
G	Turn on electric heat	Heat/Cool Time (60s)
H	Turn on electric heat stage 2	Heat/Cool Time (60s)
I	Turn off all heating	--

Parameter Description

Damper Time: This is the time (in seconds) allowed for both the opening sequence and closing sequence.

Heat/Cool Time: This is the time (in seconds) allowed for cooling sequence and heating sequence.

Status: This will display what the unit is doing as the run test progresses. The following messages may appear:

1. Not Active
2. Opening Damper
3. Closing Damper
4. Compressor Stage 1
5. Compressor Stage 2
6. Reheat Valve Open
7. Cooling Off
8. Electric Heat Stage 1
9. Electric Heat Stage 2
10. Heating Off
11. Run Test Stop

The unit will determine which items to test based on the unit model number.

3. Clear Unit Alarm Logs on Each Unit

Units may have alarms logged due to testing. Unit alarm logs must be cleared at time of installation.

To clear the wall-mount unit alarm logs:

- 1) Press MENU key to go to the Main Menu screen.
- 2) Use UP or DOWN keys and ENTER key to enter TECHNICIAN password 1313.
- 3) Press UP or DOWN keys to scroll to **Settings**; press ENTER key.
- 4) Press UP or DOWN keys to scroll to **Initialization**; press ENTER key.
- 5) Press UP or DOWN keys to scroll to **Initialization 1/5**; press ENTER key.
- 6) Press ENTER key to scroll to **Delete alarm logs?** (see Figure 31).
- 7) Press UP or DOWN key to change **NO** to **YES**.
- 8) Press ENTER key to clear all alarm logs.

FIGURE 31
Clearing Unit Alarm Logs

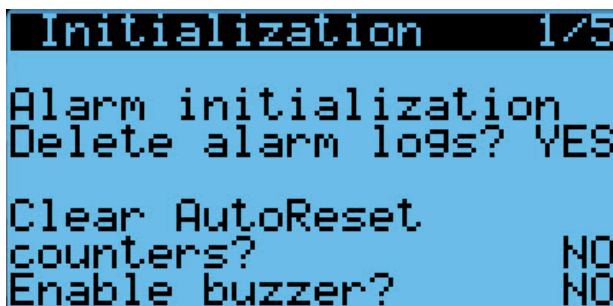

After each of the wall-mount units have been addressed, had a run test performed and had the alarm logs cleared, the rest of the system set up can proceed.

Setting Up LC6000 for Operation

The LC6000 controller will be used for the remaining steps in the set up process.

LC6000 Status Screen

The Status screen is the default start-up screen and also the return screen after 5 minutes of no activity on the LC6000. The screen can be accessed any time by pressing the ESCAPE key repeatedly.

The Status screen on the LC6000 displays the current date, time, unit displayed, zones and system status (see Figure 34).

4. Set LC Controller Date and Time

- 1) Press MENU key to access the Main Menu screen.
- 2) Use UP or DOWN keys and ENTER key to enter USER password 2000.

- 3) Press the UP or DOWN keys to scroll to the **Settings** menu; press ENTER key.
- 4) Press UP or DOWN keys to scroll to **Date/Time** menu; press ENTER key.
- 5) Press UP or DOWN keys to scroll to **Date/Time change**.
- 6) Press ENTER key to scroll to the desired value to be changed (see Figure 32).
- 7) Press UP or DOWN keys to change the value.
- 8) Press ENTER key to save and to scroll to top of screen.
- 9) Press UP or DOWN keys to scroll to **Timezone** (if applicable). Follow steps 6-8 to change timezone.
- 10) Press ESCAPE key several times to return to Main Menu screen.

NOTE: The LC6000 will sync the time and date configured to each of the wall-mount units once communication is established.

FIGURE 32
Setting Controller Date and Time

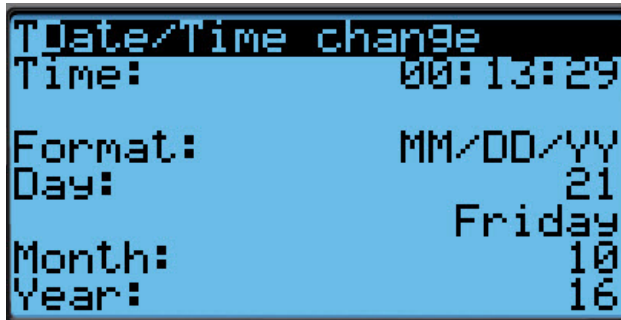

5. Configure Sensors

The system will need to be configured for the number of temperature and humidity sensors installed. The system is shipped with one combination temperature and humidity sensor.

Additional combination sensors may be purchased or alternatively, temperature-only sensors may be purchased instead. The LC is capable of utilizing five temperature sensors and four humidity sensors. The system will need to be configured for the various configurations.

If necessary, the sensors could be calibrated at this time too. For information on calibrating the sensors (adjusting the offset), see page 44.

To enable/disable **Zone 1 Indoor Humidity**:

- 1) Press MENU key to go to the Main Menu screen.
- 2) Press UP or DOWN keys and ENTER key to enter USER password 2000.
- 3) Press UP or DOWN keys to scroll to **IO Config**; press ENTER key.
- 4) Press UP or DOWN keys to scroll to **Z1 Indoor Hum C4**.
- 5) Press ENTER key to scroll to **Enable** (see Figure 33).
- 6) Press UP or DOWN key to change value to ON to enable sensor (or change value to OFF to disable sensor).

FIGURE 33
Enable/Disable Zone 1 Indoor Humidity Sensor



FIGURE 34
LC6000 Controller Display and Interface (Status Screen Shown)



LC6000 interface key functions are the same as those shown for the TEC-EYE in Figure 28 on page 36.

To enable/disable **Zone 2 Indoor Humidity**:

- 1) Press MENU key to go to the Main Menu screen.
- 2) Press UP or DOWN keys and ENTER key to enter USER password 2000.
- 3) Press UP or DOWN keys to scroll to **IO Config**; press ENTER key.
- 4) Press UP or DOWN keys to scroll to **Z2 Indoor Hum C5**.
- 5) Press ENTER key to scroll to **Enable** (see Figure 35).
- 6) Press UP or DOWN key to change value to ON to enable sensor (or change value to OFF to disable sensor).

FIGURE 35
Enable/Disable Zone 2 Indoor Humidity Sensor



To enable/disable **Zone 3 Indoor Humidity**:

- 1) Press MENU key to go to the Main Menu screen.
- 2) Press UP or DOWN keys and ENTER key to enter USER password 2000.
- 3) Press UP or DOWN keys to scroll to **IO Config**; press ENTER key.
- 4) Press UP or DOWN keys to scroll to **Z3 Indoor Hum C6**.
- 5) Press ENTER key to scroll to **Enable** (see Figure 36).

FIGURE 36
Enable/Disable Zone 3 Indoor Humidity Sensor



- 6) Press UP or DOWN key to change value to ON to enable sensor (or change value to OFF to disable sensor).

To enable/disable **Zone 1 Indoor Temperature**:

- 1) Press MENU key to go to the Main Menu screen.
- 2) Use UP or DOWN keys and ENTER key to enter USER password 2000.
- 3) Press UP or DOWN keys to scroll to **IO Config**; press ENTER key.
- 4) Press UP or DOWN keys to scroll to **Z1 Indoor Temp C7**.
- 5) Press ENTER key to scroll to **Enable** (see Figure 37).
- 6) Press UP or DOWN key to change value to ON to enable sensor (or change value to OFF to disable sensor).

FIGURE 37
Enable/Disable Zone 1 Indoor Temperature Sensor



To enable/disable **Zone 1 Remote Temperature**:

- 1) Press MENU key to go to the Main Menu screen.
- 2) Use UP or DOWN keys and ENTER key to enter USER password 2000.
- 3) Press UP or DOWN keys to scroll to **IO Config**; press ENTER key.
- 4) Press UP or DOWN keys to scroll to **Z1 Remote Temp C8**.
- 5) Press ENTER key to scroll to **Enable** (see Figure 38).
- 6) Press UP or DOWN key to change value to ON to enable sensor (or change value to OFF to disable sensor).

FIGURE 38
Enable/Disable Zone 1 Remote Temperature Sensor

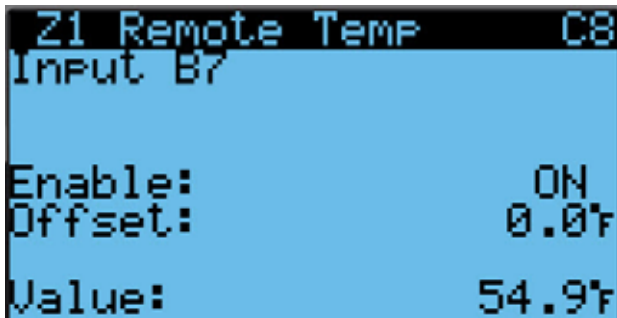

To enable/disable **Zone 2 Remote Temperature**:

- 1) Press MENU key to go to the Main Menu screen.
- 2) Use UP or DOWN keys and ENTER key to enter USER password 2000.
- 3) Press UP or DOWN keys to scroll to **IO Config**; press ENTER key.
- 4) Press UP or DOWN keys to scroll to **Z2 Remote Temp C9**.
- 5) Press ENTER key to scroll to **Enable** (see Figure 39).
- 6) Press UP or DOWN key to change value to ON to enable sensor (or change value to OFF to disable sensor).

FIGURE 39
Enable/Disable Zone 2 Remote Temperature Sensor

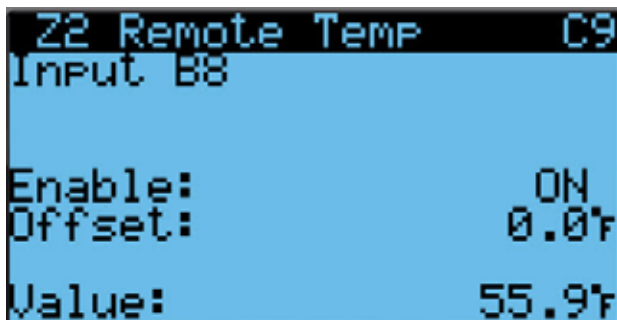

To enable/disable **Zone 3 Remote Temperature**:

- 1) Press MENU key to go to the Main Menu screen.
- 2) Use UP or DOWN keys and ENTER key to enter USER password 2000.
- 3) Press UP or DOWN keys to scroll to **IO Config**; press ENTER key.
- 4) Press UP or DOWN keys to scroll to **Z3 Remote Temp C10**.
- 5) Press ENTER key to scroll to **Enable** (see Figure 40).

- 6) Press UP or DOWN key to change value to ON to enable sensor (or change value to OFF to disable sensor).

FIGURE 40
Enable/Disable Zone 3 Remote Temperature Sensor

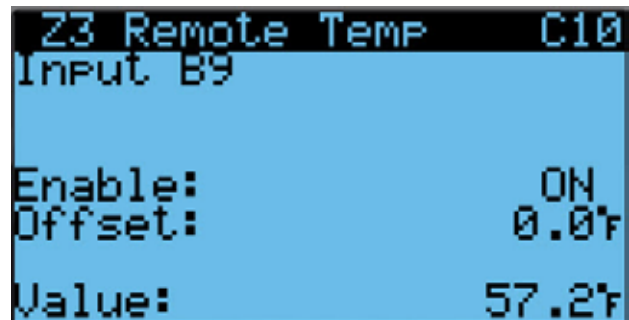

To enable/disable **Outdoor Air Humidity**:

- 1) Press MENU key to go to the Main Menu screen.
- 2) Use UP or DOWN keys and ENTER key to enter USER password 2000.
- 3) Press UP or DOWN keys to scroll to **IO Config**; press ENTER key.
- 4) Press UP or DOWN keys to scroll to **Outdoor Air Humid C11**.
- 5) Press ENTER key to scroll to **Enable** (see Figure 41).
- 6) Press UP or DOWN key to change value to ON to enable sensor (or change value to OFF to disable sensor).

FIGURE 41
Enable/Disable Outdoor Air Humidity Sensor

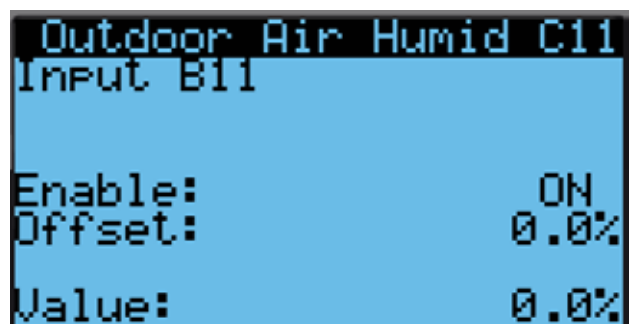

To enable/disable **Outdoor Air Temperature**:

- 1) Press MENU key to go to the Main Menu screen.
- 2) Use UP or DOWN keys and ENTER key to enter USER password 2000.
- 3) Press UP or DOWN keys to scroll to **IO Config**; press ENTER key.

- 4) Press UP or DOWN keys to scroll to **Outdoor Air Temp C12**.
- 5) Press ENTER key to scroll to **Enable** (see Figure 42).
- 6) Press UP or DOWN key to change value to ON to enable sensor (or change value to OFF to disable sensor).

FIGURE 42
Enable/Disable Outdoor Air Temperature

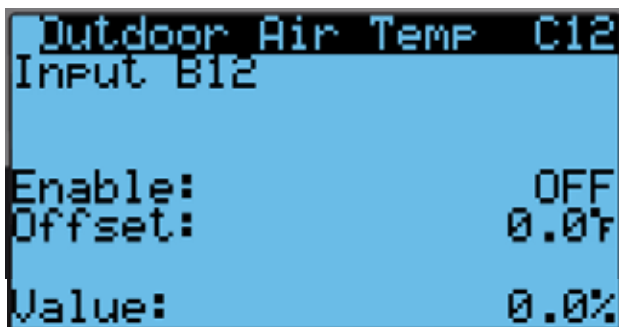

6. Enter Total Number of Units

- 1) Press MENU key to go to the Main Menu screen.
- 2) Press UP or DOWN keys and ENTER key to enter USER password 2000.
- 3) Press UP or DOWN keys to scroll to **Sys Config**; press ENTER key.
- 4) Press UP or DOWN keys to scroll to **General**; press enter key.
- 5) Press ENTER key to scroll to **Total Units** (see Figure 43).
- 6) Press UP or DOWN keys to adjust value to correct number of units.
- 7) Press ENTER key to save value.
- 8) Press the ESCAPE key several times to return to Main Menu screen.

FIGURE 43
Total Units Displayed

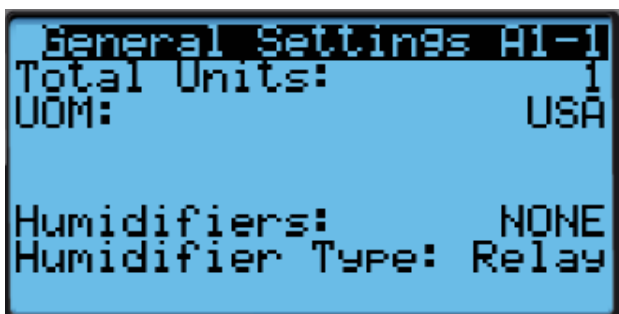

7. Verify Units Are Online

Once a unit is uniquely addressed, communication can be verified at the LC controller.

With the correct number of units set at the LC controller, each unit can be remotely viewed from the controller information screen.

To view these screens:

- 1) Press ESCAPE key to view the Status screen. (May need to be pressed more than once.)
- 2) Press UP or DOWN key until the Quick Menu in the lower right corner of the screen displays the Information icon (); press ENTER key.
- 3) Press UP or DOWN keys to scroll through the Information screens until the desired unit Information screen appears.

In addition to being able to remotely view the units, an alarm will be generated on the LC controller for units not communicating.

8. Select Economizer Type for Each Zone

Each zone can be configured to operate the economizers with different considerations. For more information on the different economizer choices, reference the most recent version of MULTI-TEC Service Instructions 2100-665.

The type of consideration can be set to none, dry bulb, temperature and humidity or enthalpy. These settings will be communicated to the wall units while connected to the LC6000 to ensure all units operate the same.

To select economizer type for each zone:

- 1) Press MENU key to go to the Main Menu screen.
- 2) Use UP or DOWN keys and ENTER key to enter password 1313.
- 3) Press UP or DOWN keys to scroll to **Sys Config**; press ENTER key.
- 4) Press UP or DOWN keys to scroll to **Zone 1**, **Zone 2** or **Zone 3**; press ENTER key.
- 5) Press UP or DOWN keys to scroll to **Zone FC Settings A2-4** (Zone 1), **Zone FC Settings A3-4** (Zone 2) or **Zone FC Settings A4-4** (Zone 3).
- 6) Press ENTER key to scroll to **Type** (see Figure 44).
- 7) Press UP or DOWN keys to change economizer type to **None**, **Drybulb**, **TempHum** or **Enthalpy**.
- 8) Press ENTER key to save.

FIGURE 44
Selecting Economizer Type

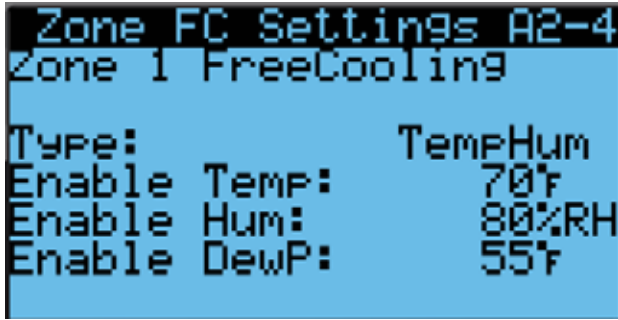

9. Clear Controller Alarm Logs

The LC6000 controller may have alarms logged due to bench testing. Controller alarm logs must be cleared at time of installation.

To clear the LC controller alarm logs:

- 1) Press MENU key to go to the Main Menu screen.
- 2) Use UP or DOWN keys and ENTER key to enter USER password 2000.
- 3) Press UP or DOWN keys to scroll to **Settings**; press ENTER key.
- 4) Press UP or DOWN keys to scroll to **Initialization**; press ENTER key.
- 5) Press ENTER key to scroll to **Delete alarm logs?** (see Figure 45).
- 6) Press UP or DOWN key to value to **YES**; press ENTER key.
- 7) Press ESCAPE key several times to return to Main Menu screen.

FIGURE 45
Clearing LC6000 Alarm Logs

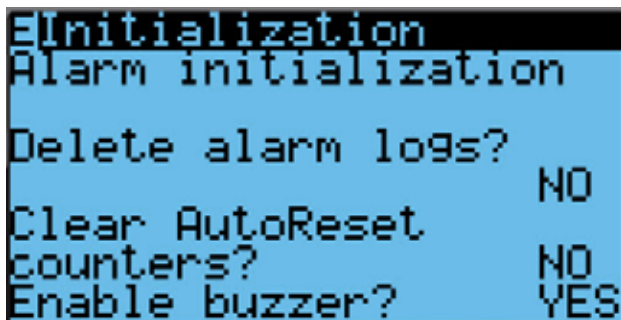

10. Complete Installation

Once all the installation steps have been completed, all alarms and alarm logs have been cleared and system verification and run test results were satisfactory, the installation can now be considered "complete".

Additional programming information can be found in MULTI-TEC Service Instructions 2100-665 and LC6000 Service Instructions 2100-669.

ADDITIONAL INFORMATION

Menu Screens and Password Levels

MULTI-TEC Wall-Mount Units

- A** System Config: User (2000)
- B** Adv Sys Config: Technician (1313)
- C** I-O Config: Technician (1313)
- D** On/Off: User (2000)
- E** Alarm Logs: User (2000)
- F** Settings
 - Date/Time: Technician (1313)
 - Language: User (2000)
 - Network Config: Technician (1313)
 - Serial Ports: Technician (1313)
- Initialization
 - Clear Logs: User (2000)
 - System Default: Engineer (9254)
 - Restart: User (2000)
 - Parameter Config: Engineer (9254)
 - Alarm Export: User (2000)
- G** Logout: Used to log out of the current password level. Entering back into the menu requires password.

LC6000 Controller

- A** System Config
 - General: User (2000)
 - Zone 1: User (2000)
 - Zone 2: User (2000)
 - Zone 3: User (2000)
- B** Adv Sys Config: B1-B13 Technician (1313)
- C** I-O Config: C1-C10 Technician (1313)
- D** On/Off: User (2000)
- E** Alarm Logs: User (2000)
- F** Settings
 - Date/Time: Technician (1313)
 - Language: User (2000)
 - Network Config: Technician (1313)
 - Serial Ports: Technician (1313)
- Initialization
 - Clear Logs: User (2000)
 - System Default: Engineer (9254)
 - Restart: User (2000)

Parameter Config: Engineer (9254)

Alarm Export: User (2000)

- G** Logout: Used to log out of the current password level. Entering back into the menu requires password.

Setpoints

The LC6000 setpoints will determine the cooling and heating setpoints when *communicating with the wall-mount units*. The *unit* cooling and heating setpoints will determine the cooling and heating setpoints when *in stand alone mode*. LC6000 setpoints will override stand alone setpoints.

If at any time the unit(s) loses communication with the LC6000 controller, the unit(s) will go into stand alone mode.

Calibrating Sensors

1. Press MENU key on LC controller interface to go to the Main Menu screen.
2. Use UP or DOWN keys and ENTER key to enter USER password 2000.
3. Press UP or DOWN keys to scroll to **I/O Config**; press ENTER key.
4. Press UP or DOWN keys to scroll to sensor to be adjusted.
5. Press ENTER key to scroll to **Offset** (see Figure 46).
6. Press UP or DOWN keys to add or subtract to the sensor offset value.
7. Press ENTER key to save.

FIGURE 46
Adjusting Sensor Offset Value



TABLE 6
MULTI-TEC Wall-Mount Unit Status Messages

Message	Description
Stand Alone	Orphan Mode Standby
th-TUNE Online	th_TUNE Standby
LC Online	LC Standby
Cont. Blower	Continuous Blower Active
Off by th-TUNE	Unit off by th-TUNE
Freecooling	Freecooling Active
Optimized Cool	Optimized Cooling Active
Cooling	Cooling Active
Heating	Heating Active
Active Dehum	Mechanical Dehumidification or Electric Reheat Active
Passive Dehum	Economizer Disable/Enhanced Latent Removal (if available)
Self Test	Self Test Running
Off by Alarm	Unit Off by Alarm Condition
Off by BMS	Unit Off by BMS
Off by LC	Unit Off by LC Master
Off by Keypad	Unit Off by Keypad
Emergency Vent	Emergency Vent Mode Active
Emergency Cool	Emergency Cool Mode Active
Emergency Off	Emergency Off Mode Active

TABLE 7
LC6000 Status Messages

Message	Description
On	The system is on
Off by Alarm	The system has a major fault and is disabled
Off by BMS	The system has been disabled by network supervisor
Off by Keypad	The system has been turned off by local user
Emergency Cooling	The system has detected a high temperature alarm and one or more zones are emergency cooling
Emergency Vent	The system has detected hydrogen and one or more zones are in emergency ventilation