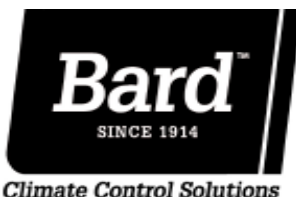

INSTALLATION INSTRUCTIONS

ELECTRIC HEAT PACKAGES

Models:

EHW18H-A04	EHW3TA-C12	EHW36H-B09B	EHWC03A-C06
EHW18H-A08	EHW3TA-C15	EHW36H-B15B	EHWC03A-C09
EHW2TA-A05	EHW3TH-A10	EHWA02-A05B	EHWH02A-A04B
EHW2TA-A08	EHW3TH-A15	EHWA02A-A08B	EHWH02A-A08B
EHW2TA-A10	EHW3TH-B15	EHWA02A-A10B	EHWH03-B06B
EHW2TA-B06	EHW3TH-C06	EHWA03-A05B	EHWH03-B09B
EHW2TH-A04	EHW3TH-C15	EHWA03-A08B	EHWH03A-C15
EHW2TH-A08	EHW02A-A08B	EHWA03-A10B	EHWH24-B06B
EHW3TA-A05	EHW24A-A08	EHWA03-A15B	EHWH24B-C06
EHW3TA-A08	EHW24H-A04B	EHWA03-A10D	EHWH30-A05B
EHW3TA-A10	EHW24H-A08B	EHWA03-B06B	EHWH30-A10B
EHW3TA-A15	EHW24H-B06B	EHWA03-B09B	EHWH31-C06
EHW3TA-B06	EHW30A-A05B	EHWA03-B15	EHWH36-A05B
EHW3TA-B09	EHW30A-B06	EHWA03A-C15	EHWH36-A10B
EHW3TA-B15	EHW30H-A10	EHWA24-B06B	EHWH36-A15B
EHW3TA-C06	EHW36A-B06B	EHWA24A-A04B	EHWH36-B15
EHW3TA-C09	EHW36H-B06B	EHWA37-B15B	

For Use with WA and WH Series
Wall-Mounted Air Conditioners and Heat Pumps
(See Tables 1A – 1I for Model Usage Matrix)



Bard Manufacturing Company, Inc.
Bryan, Ohio 43506
www.bardhvac.com

Manual: 2100-268K
Supersedes: 2100-268J
Date: 12-17-15

CONTENTS

Description	3
Important.....	3
Shipping Damage	3
Unpacking the Electric Heat Package	3
Wiring Main Power	11
Installation	11

Figures

Figure 1	Wiring – Main Power	10
Figure 2	Electric Heat Access Panel and Control Panel Cover Locations.....	12
Figure 3	Screw Mounting Holes	12
Figure 4	A through D	14
Figure 4E	Installing Heater Package with Two Heat Strips	15
Figure 4F	Installing Heater Package with Two Heat Strips	16
Figure 5	Installing Heater Base and Connecting	17
Figure 6	Serial Plate Showing Approved Heater Packages.....	18

Tables

Table 1A	Approved Heater Usage Matrix	4
Table 1B	Approved Heater Usage Matrix	5
Table 1C	Approved Heater Usage Matrix	5
Table 1D	Approved Heater Usage Matrix	6
Table 1E	Approved Heater Usage Matrix	6
Table 1F	Approved Heater Usage Matrix	7
Table 1G	Approved Heater Usage Matrix	7
Table 1H	Approved Heater Usage Matrix	8
Table 1I	Approved Heater Usage Matrix	8
Table 2	Electrical Data and BTU Output	9
Table 3	References to Figures 3 and 4 by Model Number	13

BARD MANUFACTURING COMPANY, INC.
BRYAN, OHIO 43506

DESCRIPTION

The EHWA, EHWH and EHWC series electric heater packages are field-installable heater packages suitable for use with Bard wall mount hi boy air conditioners and heat pumps. The packages consist of the electric heat strip, the heater control base which includes the heat contactors, and circuit breaker or pull disconnects, installation instructions and wiring diagrams. See Table 2 on page 9 for nominal electrical data and BTU output. ***Before installation, check unit serial plate to ensure the heater package model to be installed is a listed heater package that is suitable for use with the Bard wall mount hi boy unit*** (see Figure 6 on page 18).

IMPORTANT

The equipment covered in this manual is to be installed by trained, experienced service and installation technicians.

SHIPPING DAMAGE

Upon receipt of equipment, the carton should be checked for external signs of shipping damage. If damage is found, the receiving party must contact the last carrier immediately, preferably in writing, requesting inspection by the carrier's agent.

UNPACKING THE ELECTRIC HEAT PACKAGE

Remove the heat package from the shipping carton. The heat package must consist of the following:

1. Basic heater.
2. Electric heat control base and wiring.
3. Installation instructions.
4. Two wiring diagrams, one to be applied to unit.
5. Adhesive label to remark serial plate to indicate new model number. This is attached to the front of these instructions.

TABLE 1A
R-22 Approved Heater Usage Matrix

240/220V		WA182-A	WA182-D	WA242-A	WA242-D	WA242HA	WA253-A	WA253-D	WA302-A	WA302-D	WA361-A	WA361-D	WA372-A	WA372-D	WE252-D	WE301-D	WE371-D	WH183-A	WH242-A	WH242DA	WH301-A	WH301DA	WH301LA	WH361-A	WH361DA	WH361HA	WH361LA	
EHWA02-A05B	X	X	X	X	X		X	X	X	X	X	X	X	X	X	X	X	X	X	X	X	X	X	X	X	X	X	
EHWA02A-A08B	X	X	X	X	X		X	X	X	X	X	X	X	X	X	X	X	X	X	X	X	X	X	X	X	X	X	
EHWA02A-A10B	X	X	X	X	X		X	X	X	X	X	X	X	X	X	X	X	X	X	X	X	X	X	X	X	X	X	
EHWA03-A05B									X	X	X	X	X	X	X	X	X	X	X	X	X	X	X	X	X	X	X	
EHWA03-A08B									X	X	X	X	X	X	X	X	X	X	X	X	X	X	X	X	X	X	X	
EHWA03-A10B									X	X	X	X	X	X	X	X	X	X	X	X	X	X	X	X	X	X	X	
EHWA03-A15B									X	X	X	X	X	X	X	X	X	X	X	X	X	X	X	X	X	X	X	
EHWA24A-A04B				X	X		X																					
EHWH02A-A04B						X																						
EHWH02A-A08B						X																						
EHWH30-A05B																												
EHWH30-A10B																												
EHWH36-A05B																												
EHWH36-A10B																												
EHWH36-A15B																												

TABLE 1D
R-410A Approved Heater Usage Matrix

240/220V 1 Phase	W18A#-A	W24A#-A	W24A#-D	W30A#-A	W30A#-D	W36A#-A	W36A#-D	W18H#-A	W24H#-A	W24H#DA	W30H#-A	W30H#DA	W36H#-A	W36H#DA
	EHW02A-A08B	X	X											
EHW24H-A04B									X	X				
EHW24H-A08B									X	X				
EHWA02-A05B	X	X	X											
EHWA02A-A08B			X											
EHWA02A-A10B	X	X												
EHWA03-A05B				X	X	X	X							
EHWA03-A08B				X		X								
EHWA03-A10B				X	X	X	X							
EHWA03-A15B				X		X								
EHWA24A-A04B		X												
EHWH02A-A04B								X						
EHWH02A-A08B								X						
EHWH30-A05B											X			
EHWH30-A10B											X			
EHWH36-A05B												X	X	X
EHWH36-A10B												X	X	X
EHWH36-A15B													X	

– Indicates numeric revision level (e.g., 1, 2, 3, ...)

TABLE 1E
R-410A Approved Heater Usage Matrix

240/220V 1 Phase	W18A*-A	W24A*-A	W24A*-D	W30A*-A	W30A*-D	W36A*-A	W36A*-D	W30A*DA	W36A*DA	W18H*-A	W24H*-A	W24H*DA	W30H*-A	W30H*DA	W36H*-A	W36H*DA
	EHW2TA-A08	X	X													
EHW2TH-A04											X	X				
EHW2TH-A08											X	X				
EHW2TA-A05	X	X	X													
EHW24A-A08			X													
EHW2TA-A10	X	X														
EHW3TA-A05				X		X	X	X	X							
EHW30A-A05B					X											
EHW3TA-A08				X		X		X	X							
EHW3TA-A10				X	X	X	X	X	X							
EHW3TA-A15				X		X										
EHWA24A-A04B		X														
EHW18H-A04										X						
EHW18H-A08										X						
EHWH30-A05B													X			
EHW30H-A10													X			
EHWH36-A05B														X	X	X
EHW3TH-A10														X	X	X
EHW3TH-A15															X	

* – Indicates alphabetic revision level (e.g., A, B, C, ...)

TABLE 1F
R-410A Approved Heater Usage Matrix

240/220V 230/208V 3 Phase	W24A#-B	W30A#-B	W36A#-B	W36A#-E	W24H#-B	W24H#DB	W30H#-B	W30H#DB	W36H#-B	W36H#DB
EHW24H-B06B					X	X				
EHW36A-B06B			X							
EHW36H-B06B									X	X
EHW36H-B09B								X		X
EHW36H-B15B									X	
EHWA03-B06B		X		X						
EHWA03-B09B		X	X							
EHWA24-B06B	X									
EHWA37-B15B		X	X							
EHWH03-B06B							X	X		
EHWH03-B09B							X		X	

– Indicates numeric revision level (e.g., 1, 2, 3, ...)

TABLE 1G
R-410A Approved Heater Usage Matrix

240/220V 230/208V 3 Phase	W24A*-B	W30A*-B	W36A*-B	W36A*-E	W30A*DB	W36A*DB	W24H*-B	W24H*DB	W30H*-B	W30H*DB	W36H*-B	W36H*DB
EHWH24-B06B							X	X				
EHW3TA-B06			X			X						
EHW36H-B06B											X	X
EHW36H-B09B										X		X
EHW3TH-B15											X	
EHW30A-B06		X		X	X							
EHW3TA-B09		X	X		X	X						
EHW2TA-B06	X											
EHW3TA-B15		X	X									
EHWH03-B06B									X	X		
EHWH03-B09B									X		X	

* – Indicates alphabetic revision level (e.g., A, B, C, ...)

TABLE 1H
R-410A Approved Heater Usage Matrix

415V 460V 3 Phase	W24A#-C	W24A#-F	W24H#-C	W24H#DC	W30AV-C	W30A#-F	W36A#-C	W36A#-F	W30H#-C	W30H#DC	W36H#-C	W36H#DC
EHWA03A-C15					X	X	X	X				
EHWC03A-C06					X		X		X	X	X	X
EHWC03A-C09					X	X	X	X	X	X	X	X
EHWH03A-C15									X		X	
EHWH24B-C06	X	X	X	X								

– Indicates numeric revision level (e.g., 1, 2, 3, ...)

TABLE 1I
R-410A Approved Heater Usage Matrix

415V 460V 3 Phase	W24A*-C	W24A*-F	W24H*-C	W24H*DC	W30A*-C	W30A*-F	W36A*-C	W36A*-F	W30A*DC	W36A*DC	W30H*-C	W30H*DC	W36H*-C	W36H*DC
EHW3TA-C15					X	X	X	X						
EHW3TA-C06					X		X							
EHW3TA-C09					X	X	X	X	X	X	X	X	X	X
EHW3TH-C15											X		X	
EHWH24B-C06	X	X	X	X										
EHW3TA-C12					X		X							
EHW3TH-C06											X	X	X	X

* – Indicates alphabetic revision level (e.g., A, B, C, ...)

TABLE 2
Electrical Data and BTU Output

Heater Package Model	Volts	Phase	Nominal KW	Nominal BTU
EHWA24A-A04B	240/208	1	4 / 3	13,650 / 10,240
EHW2TA-A05, EHWA02-A05B	240/208	1	5 / 3.75	17,065 / 12,800
EHW24A-A08, EHWA02A-A08B	240/208	1	8 / 6	27,300 / 20,475
EHW2TA-A10, EHWA02A-A10B	240/208	1	10 / 7.5	34,130 / 25,600
EHW2TA-B06, EHWA24-B06B	240/208	3	6 / 4.5	20,475 / 15,350
EHW18H-A04, EHWH02A-A04B	240/208	1	4 / 3	13,650 / 10,240
EHW18H-A08, EHWH02A-A08B	240/208	1	8 / 6	27,300 / 20,475
EHWH24-B06B	240/208	3	6 / 4.5	20,475 / 15,350
EHWH24B-C09	480	3	9	30,715
EHW3TA-A05, EHWA03-A05B	240/208	1	5 / 3.75	17,065 / 12,800
EHW3TA-A08, EHWA03-A08B	240/208	1	8 / 6	27,300 / 20,475
EHW3TA-A10, EHWA03-A10B	240/208	1	10 / 7.5	34,130 / 25,600
EHW3TA-A15, EHWA03-A15B	240/208	1	15 / 11.25	51,195 / 23,035
EHW30A-B06, EHWA03-B06B	240/208	3	6 / 4.5	20,475 / 15,350
EHW3TA-B09, EHWA03-B09B	240/208	3	9 / 6.75	30,715 / 23,035
EHWA03-B15	240/208	3	15 / 11.25	51,195 / 38,400
EHW3TA-C15, EHWA03A-C15	480	3	15	51,195
EHW3TA-B15, EHWA37-B15B	240 / 208	3	15 / 11.25	51,195 / 38,400
EHWH30-A05B	240/208	1	5 / 3.75	17,065 / 12,800
EHW30H-A10, EHWH30-A10B	240/208	1	10 / 7.5	34,130 / 25,600
EHWH36-A05B	240/208	1	5 / 3.75	17,065 / 12,800
EHW3TH-A10, EHWH36-A10B	240/208	1	10 / 7.5	34,130 / 25,600
EHW3TH-A15, EHWH36-A15B	240/208	1	15 / 11.25	51,195 / 38,400
EHWH03-B06B	240/208	3	6 / 4.5	20,475 / 15,350
EHWH03-B09B	240/208	3	9 / 6.75	30,715 / 23,035
EHW36H-B06B	240/208	3	6 / 4.5	20,475 / 15,350
EHWH36-B15	240/208	3	15 / 11.25	51,195 / 38,400
EHW3TA-C06, EHWC03A-C06	480	3	6	20,475
EHW3TA-C09, EHWC03A-C09	480	3	9	30,715
EHW3TH-C15, EHWH03A-C15	480	3	15	51,195
EHW3TH-C06, EHWH31-C06	480	3	6	20,475
EHW2TH-A04, EHW24H-A04B	240/208	1	4 / 3	13,650 / 10,240
EHW2TH-A08, EHW24H-A08B	240/208	1	8 / 6	27,300 / 20,475
EHW24H-B06B	240/208	3	6 / 4.5	20,475 / 15,350
EHW36H-B09B	240/208	3	9 / 6.75	20,475 / 15,350
EHW3TH-B15, EHW36H-B15B	240/208	3	15 / 11.25	51,195 / 38,400
EHW3TA-B06, EHW36A-B06B	240/208	3	6 / 4.5	20,475 / 15,350
EHW2TA-A08, EHW02A-A08B	240/208	1	8 / 6	27,300 / 20,475
EHWA03-A10D	240/208	1	10 / 7.5	34,130 / 25,600
EHW30A-A05B	240/208	1	5 / 3.75	17,065 / 12,800
EHW3TA-C12	480	3	12	40,955

FIGURE 1
Wiring – Main Power

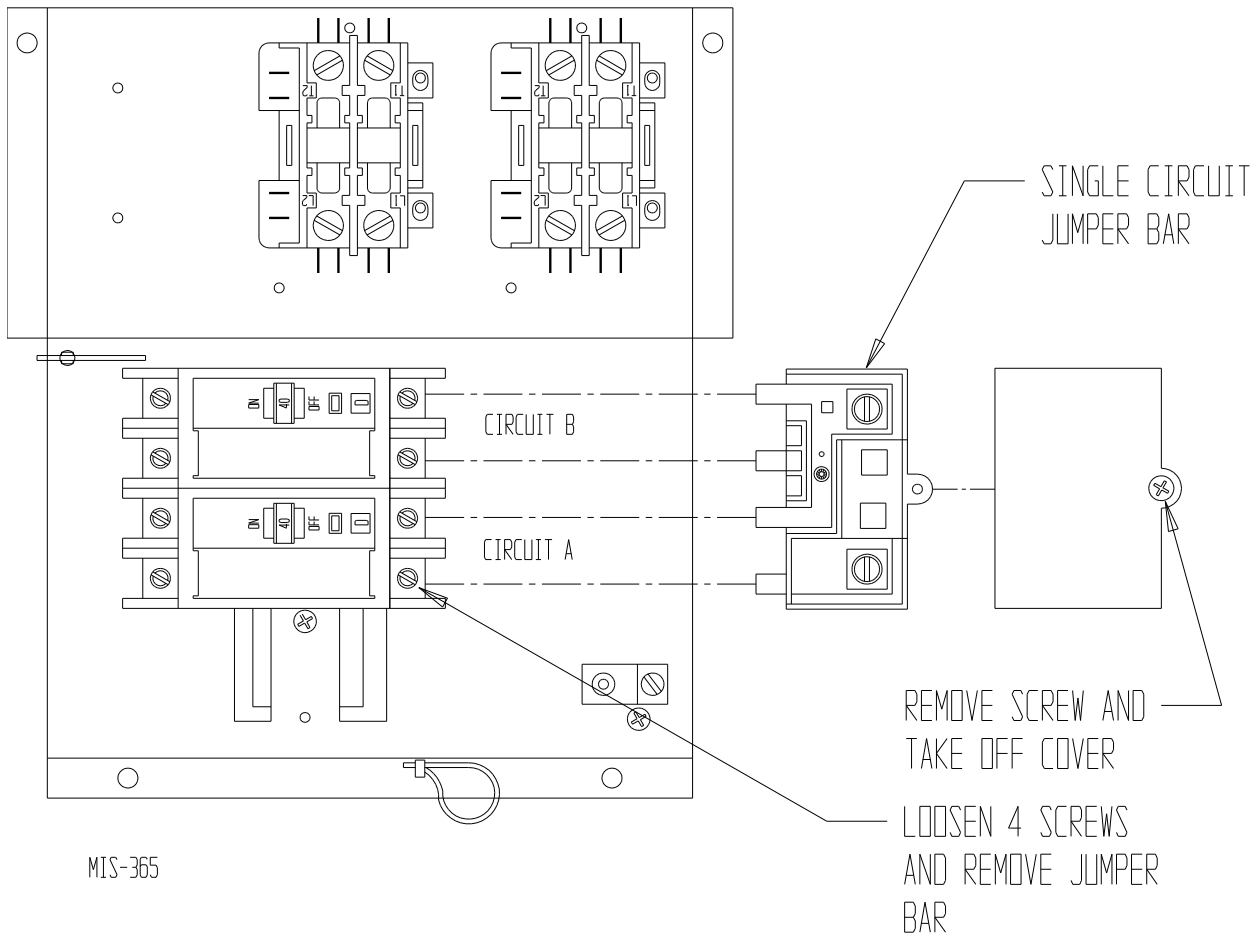

WIRING MAIN POWER

1. On all installations, size unit power supply wiring for the minimum circuit ampacity requirement for the unit and heater package combination listed on the unit serial plate.



WARNING

Install properly sized power supply leads for the unit/heater combination minimum circuit ampacity as listed on the unit serial plate. Hazard of fire. Failure to install properly sized conductors could result in fire causing damage, bodily injury or death.

2. All heater packages covered by this manual are factory wired for single supply circuit. The following heater packages are field convertible to a dual supply circuit if required or desired:

EHWA03-A15B	EHW3TA-A15
EHWH30-A10B	EHW3TH-A15
EHWH36-A10B	EHW3OH-A10
EHWH36-A15B	EHW3TH-A10

3. To convert the above heater packages to dual circuit configuration before installation, loosen four (4) screws holding jumper bar in place. Remove jumper bar. Circuits A + B are now identified on the heater package. See Figure 1 on page 10.

Wire should be sized to the minimum circuit ampacity as specified on the serial plates of units that accept these heater packages for circuits A + B.

INSTALLATION

1. Disconnect all power to unit before installation.



WARNING

Disconnect all power to unit before installing heater package. Hazard of electrical shock. Failure to disconnect power could result in injury or death.

2. Before installation, check unit serial plate to insure that the heater package model to be installed is listed as a heater package suitable for use with the unit.

Under no circumstance shall a heater package be installed in a unit if the model number of the heater package does not appear on the unit serial plate.



WARNING

Install only heater packages listed on unit serial plate. Hazard of fire or electrical shock. Failure to install listed heater package could result in fire, injury or death.

3. Remove electric heater access panel and control panel cover, both inner and outer (see Figure 2 on page 12).
4. All heaters are installed with the thermal cutoffs positioned to the top of the unit. Install heat strip(s) through heater access opening. Position heat strip support rod in heater support hole 1, 2 or 3 as indicated in Table 3 on page 13 and Figure 3 on page 12.

On heater packages with two heat strips, install 9KW or 10KW heater first in position closest to the outlet air frame (see Figure 4E on page 15 or Figure 4F on page 16).

5. Install heater control base into top of control panel as shown in Figure 5 on page 17. Secure with four (4) sheet metal screws provided.
6. Plug male 6-pin connector into mating connector mounted in control panel (see Figure 5).
7. Connect red compressor supply lead to L1 of terminal block. Connect black compressor supply lead to L2 of terminal block. If three phase, connect yellow supply lead to L3 of terminal block. See Figure 5 and wiring diagram.
8. Route wires from heater control base up through raceway in top right corner of control panel to the heaters (see Figure 5).
9. Wire heater package per wiring diagram supplied with this heater package. All wires are stamped with wire numbers that correspond with terminal numbers on the wiring diagram and stamped numbers on the heat strip. Limit switch wires are terminated with insulated quick connect terminals. See Figure 5.
10. Attach adhesive wiring diagram directly above unit wiring diagram on inner control panel cover.
11. Recheck all wiring. Break out appropriate circuit breaker tabs on inner control panel cover to allow

trip lever to protrude. Replace control panel and heater access panels.

12. Resupply power to the unit and check for proper operation.
13. Remark serial plate with self-adhesive label attached to the front of this manual (see Figure 6 on page 18).

FIGURE 2
Electric Heater Access Panel
and Control Panel Cover Locations

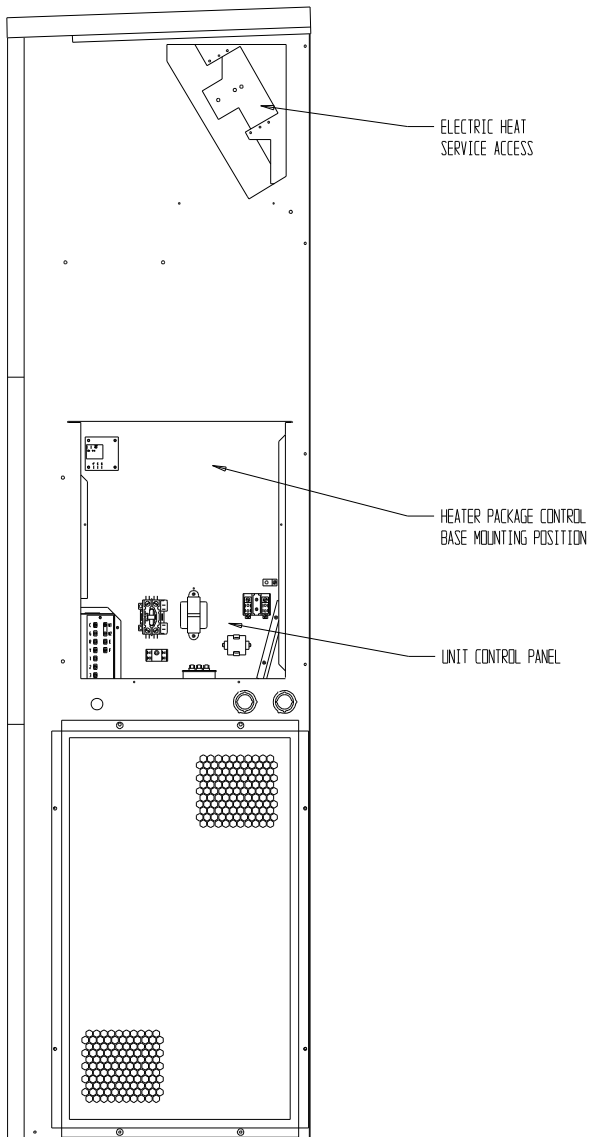

FIGURE 3
Screw Mounting Holes

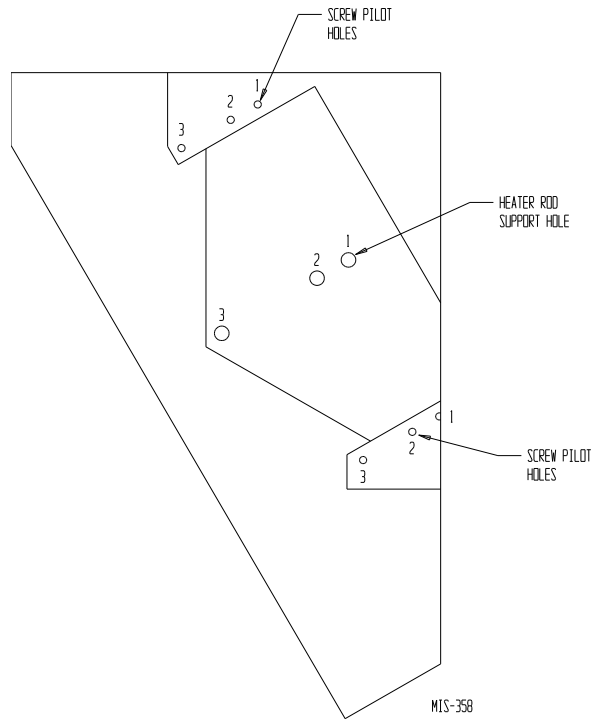
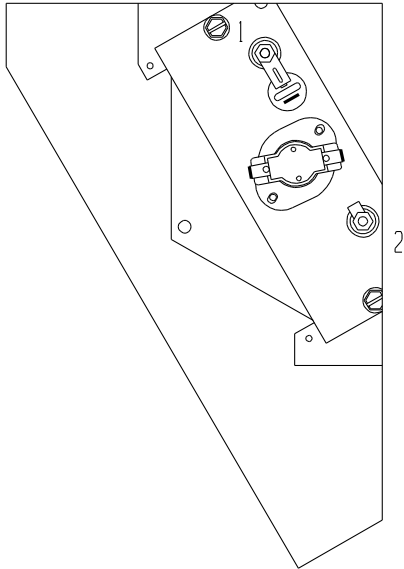

TABLE 3
References to Figures 3 and 4
for Model Number

	Heater Package Model Number	Figure 4 Heater Terminal Identification Drawing	Figure 3 Rod Support and Screw Mounting Position
1.	EHW2TA-A05, EHWA02-A05B	4A	1
2.	EHW24A-A08, EHWA02A-A08B	4B	1
3.	EHW2TA-A10, EHWA02A-A10B	4B	1
4.	EHW3TA-A05, EHWA03-A05B	4A	1
5.	EHW3TA-A08, EHWA03-A08B	4B	1
6.	EHW3TA-A10, EHWA03-A10B	4B	1
7.	EHWA03-A15B	4D	2
8.	EHW30A-B06, EHWA03-B06B	4C	1
9.	EHW3TA-B09, EHWA03-B09B	4C	1
10.	EHWA03-B15	4D	2
11.	EHW3TA-C15, EHWA03A-C15	4E	1 + 3
12.	EHW2TA-B06, EHWA24-B06B	4C	1
13.	EHWA37-B15B	4D	1 + 3
14.	EHW3TA-C06, EHWC03A-C06	4C	1
15.	EHW3TA-C09, EHWC03A-C09	4C	1
16.	EHW18H-A04, EHWH02A-A04B	4A	1
17.	EHW18H-A08, EHWH02A-A08B	4B	1
18.	EHWH03-B06B	4C	1
19.	EHWH03-B09B	4C	1
20.	EHWH03A-C15	4E	1 + 3
21.	EHWH24-B06B	4C	1
22.	EHWH24B-C06	4C	1
23.	EHWH30-A05B	4A	1
24.	EHW30H-A10, EHWH30-A10B	4B	1
25.	EHWH36-A05B	4A	1
26.	EHW3TH-A10, EHWH36-A10B	4B	1
27.	EHWH36-A15B	4D	2
28.	EHW36H-B06B	4C	1
29.	EHWH36-B15	4E	1 + 3
30.	EHWA24A-A04B	4A	1
31.	EHW3TH-C06, EHWH31-C06	4C	1
32.	EHW2TH-A04, EHW24H-A04B	4A	1
33.	EHW2TH-A08, EHW24H-A08B	4B	1
34.	EHW24H-B06B	4C	1
35.	EHW36H-B09B	4C	1
36.	EHW36H-B15B	4E	1 + 3
37.	EHW3TA-B06, EHW36A-B06B	4C	1
38.	EHW2TA-A08, EHW02A-A08B	4B	1
39.	EHW3TH-A15, EHW3TA-A15	4F	1 + 3
40.	EHW3TA-C12, EHW3TA-B15	4E	1 + 3
41.	EHW30A-A05B	4A	1
42.	EHW3TH-C15, EHW3TH-B15	4E	1 + 3

**FIGURE 4
A Through D**

FIGURE 4A



EHW2TA-A05
 EHW3TA-A05
 EHW30A-A05B
 ESH31-A04B
 EHWA24A-A04B
 EHH36-A05B
 EHH30-A05B
 EHWA03-A05B
 EHH02A-A04B
 EHWA02-A05B
 EHW24H-A04B

EHW2TH-A04
 EHW18H-A04

FIGURE 4C

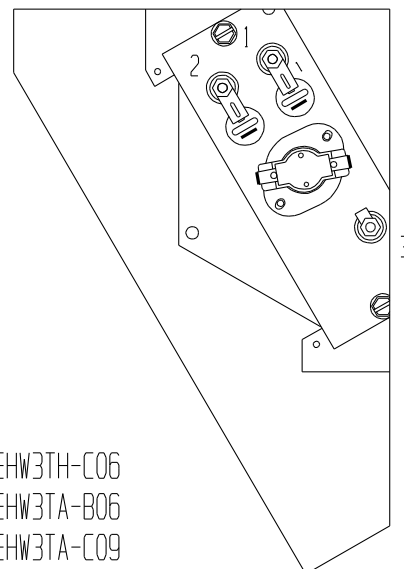

EHWA03-B06B
 EHWA03-B09B
 EHW03A-C06
 EHW03A-C09
 EHH03-B06B
 EHH03-B09B
 EHH24-B06B
 EHWA24-B06B
 EHH24B-C06
 ESH31-C06
 ESH31-B06B
 EHH31-C06
 EHW24H-B06B
 EHW36H-A08B
 EHW36H-B06B
 EHW36H-B09B
 EHW36A-B06B

EHW3TH-C06
 EHW3TA-B06
 EHW3TA-C09
 EHW3TA-C06
 EHW2TA-B06
 EHW3TA-B09
 EHW30A-B06

FIGURE 4B

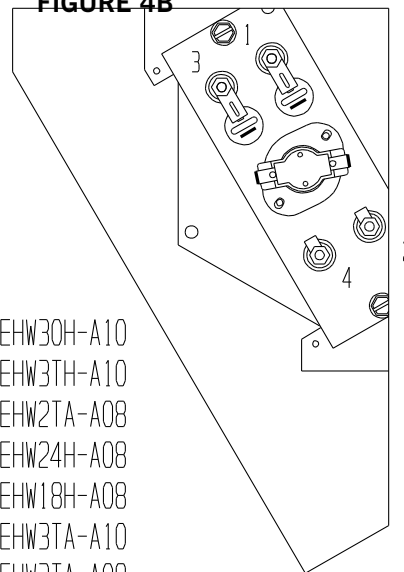

EHWA03-A10D
 EHWA03-A10B
 EHWA03-A08B
 EHH30-A10B
 EHH36-A10B
 EHWA02A-A10B
 EHWA02A-A08B
 EHH02A-A08B
 ESH31-A08B
 EHW24H-A08B
 EHW02A-A08B

EHW30H-A10
 EHW3TH-A10
 EHW2TA-A08
 EHW24H-A08
 EHW18H-A08
 EHW3TA-A10
 EHW3TA-A08
 EHW2TA-A10
 EHW24A-A08

FIGURE 4D

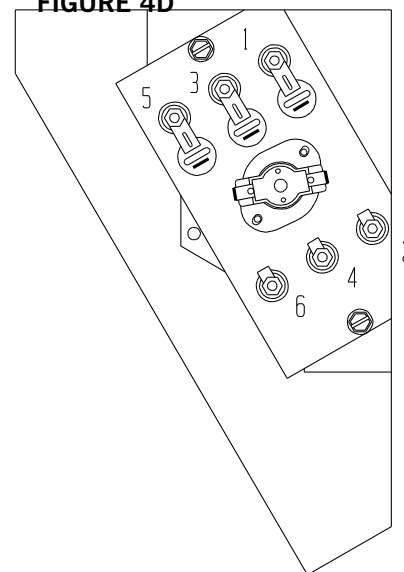

EHH36-A15B
 EHWA03-A15B
 EHWA03-B15B
 EHWA37-B15B

NOTE: THERMAL CUTOFFS TO BE AT
 TOP OF AIR FRAME WHEN INSTALLING.

MIS-363 H

FIGURE 4E
Installing Heater Package with
Two Heat Strips

EHW3TH-B15
EHW3TH-C15
EHWH36-B15
EHWH03A-C15
EHWAO3A-C15
EHW36H-B15B
EHW3TA-C15
EHW3TA-B15
EHW3TA-C12

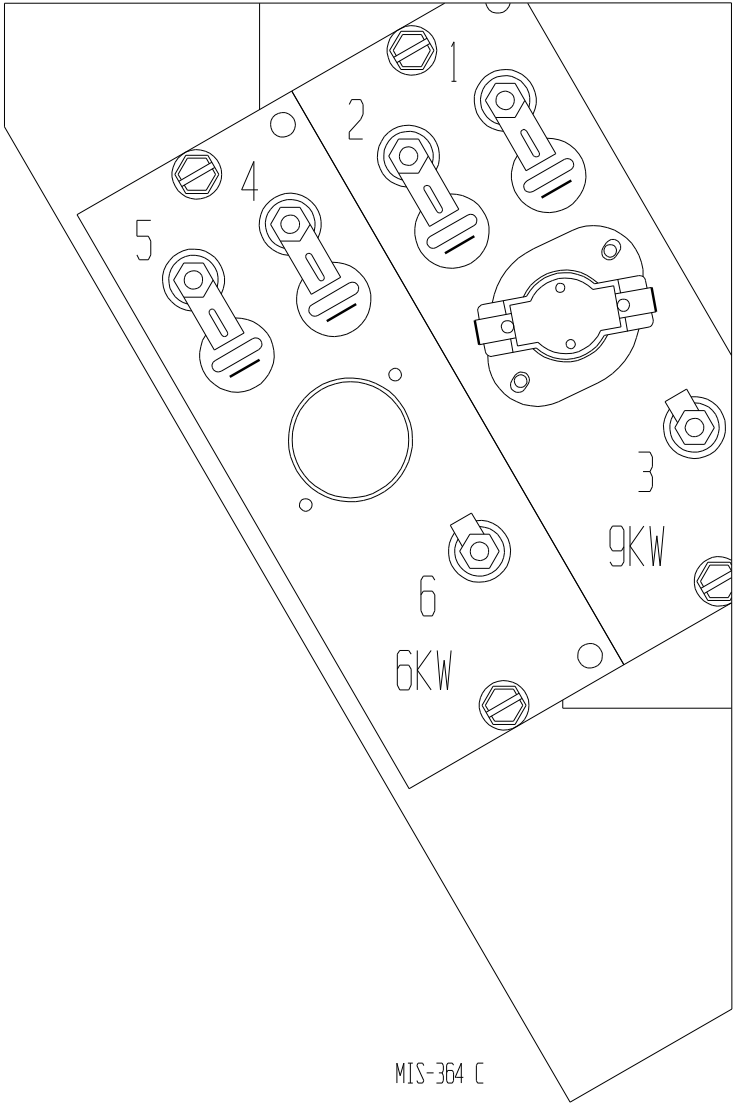
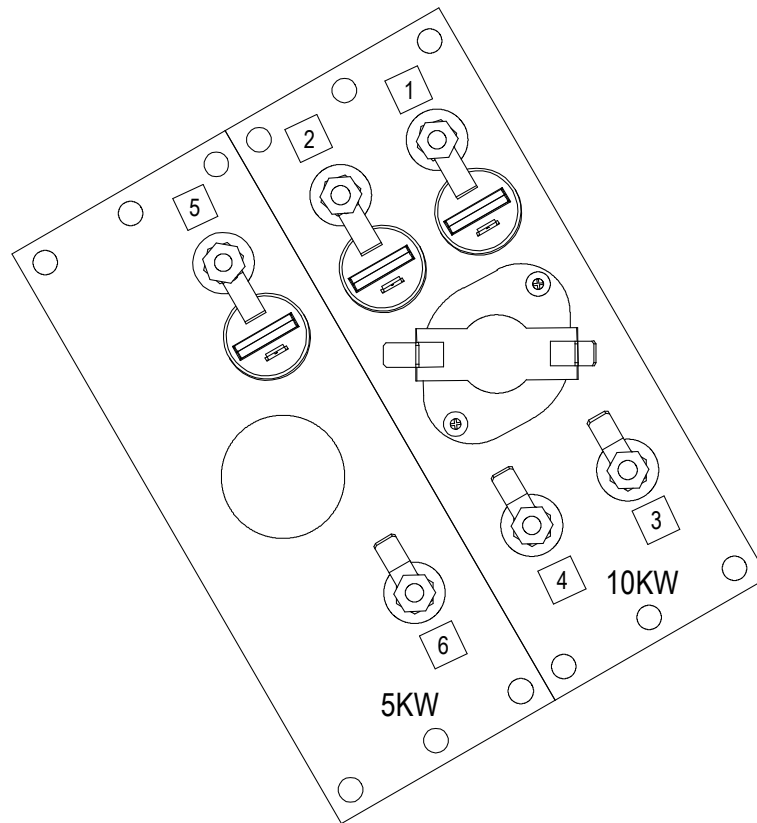

FIGURE 4F
Installing Heater Package with
Two Heat Strips



MIS-3819

EHW3TA-A15
EHW3TH-A15

FIGURE 5
Installing Heater Base
and Connecting

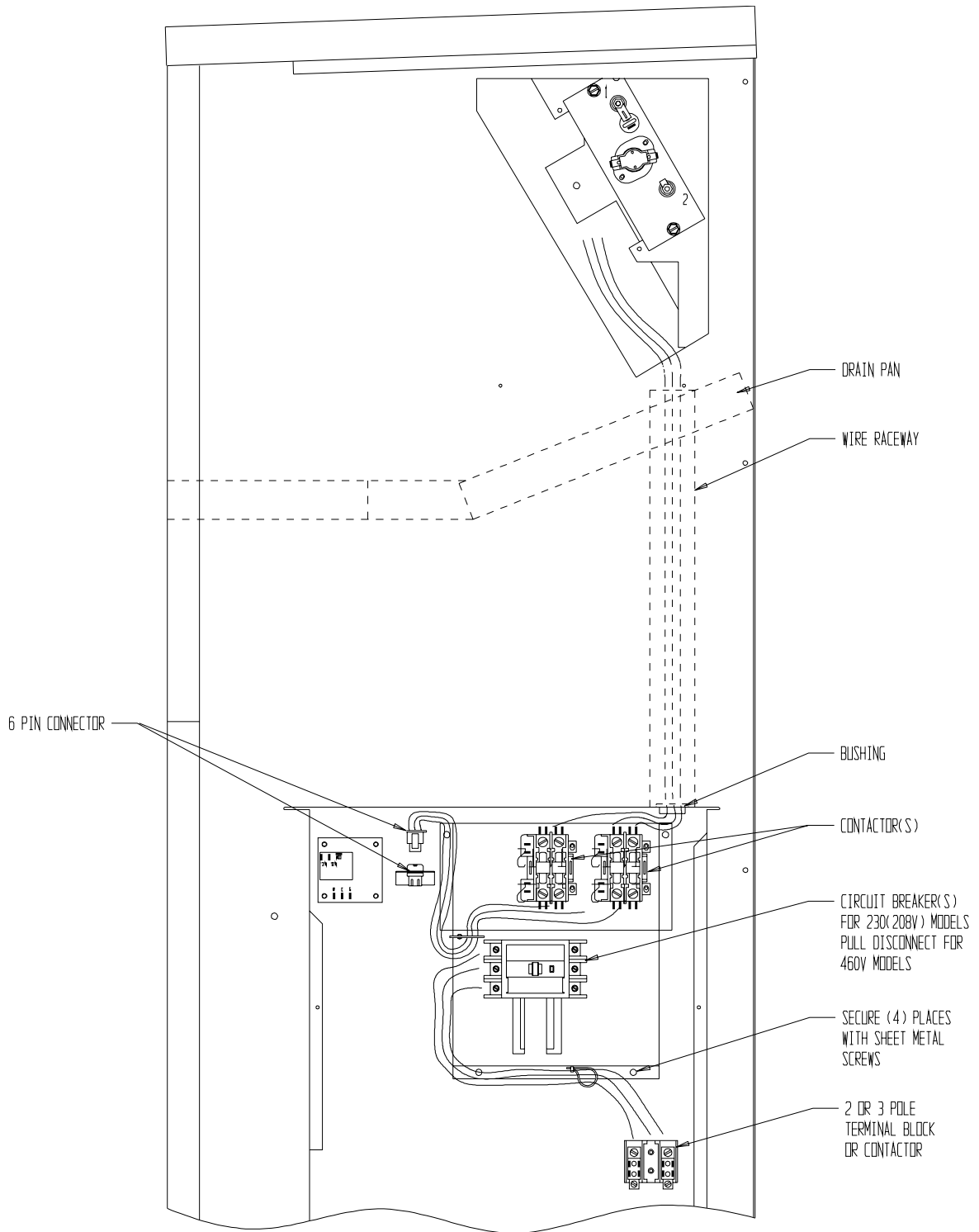

MIS-422 A

FIGURE 6
Serial Plate Showing
Approved Heater Packages

INSTALL ONLY HEATER PACKAGES LISTED HERE.

BARD MANUFACTURING COMPANY, 1914 RANDOLPH DRIVE

(1)
 APPROVED
 HEATER
 PACKAGE

MODEL	VAC	HZ
() JWA361-A0012345	NONE	230/208 60
() JWA361-A0512345	EHWA03-A05	230/208 60
(X) JWA361-A0812345	EHWA03-A08	230/208 60
() JWA361-A1012345	EHWA03-A10	230/208 60
() JWA361-A1512345	EHWA03-A15	230/208 60

BRANCH CIRCUIT SELECT CURRENT 17 OPERATION

SERIAL NUMBER 125H920711193-01 U/L FILE NO.

SUITABLE FOR OUTDOOR USE

COMPRESSOR	VAC	HZ	PH	ELECTRICAL
OUTDOOR MOTOR	230/208	60	1	HP
INDOOR MOTOR	230/208	60	1	1/5
				1/3
HEATER PACKAGE				KW
EHWA03-A05	240/208	60	1	5/3.75
EHWA03-A08	240/208	60	1	8/6
EHWA03-A10	240/208	60	1	10/7.5
EHWA03-A15	240/208	60	1	15/11.25

-- FACTORY
 FACTORY CHARGED R22: 68 OZ. DESI
 -- CLEAR

(X)	()	()	()	()	()
()	(X)	()	()	()	()
()	()	(X)	()	()	()
()	()	()	(X)	()	()
()	()	()	()	()	(X)

ASSURE THAT SERIAL PLATE IS CLEAN AND DRY, REMOVE APPROPRIATE LABEL STRIP FOR KW REQUIRED AND REMARK SERIAL PLATE AS SHOWN FOR THE HEATER PACKAGE THAT IS INSTALLED