INSTALLATION INSTRUCTIONS

ELECTRIC HEAT PACKAGES

Models:	EHWH42-A05	EHWA05-A05
	EHWH42-A10	EHWA05-A10
	EHWH42-A15	EHWA05-A15
	EHWH42-C06	EHWA05-A20
	EHWH04-A04	EHWA05-B09
	EHWH04-A05	EHWA05-B15
	EHWH04-A10	EHWA05-B18
	EHWH04-A15	EHWA05A-C09
	EHWH04-A20	EHWA05A-C15
	EHWH04-B18	EHWA60-A05
	EHWH05-B09	EHWA60-B09
	EHWH05-B15	EHW05A-B18
	EHWH05A-C09	EHW05H-B18
	EHWH05A-C15	EHW60A-B09
	EHWH05-B06	EHW70A-B09
		EHW70A-B18

**FOR WITH WA, SH AND WH SERIES
WALL MOUNTED AIR CONDITIONERS
AND HEAT PUMPS
(SEE TABLES 1A — 1F FOR MODEL USAGE)**



Bard Manufacturing Company, Inc.
Bryan, Ohio 43506
Since 1914...Moving ahead, just as planned.

Manual: 2100-254E
Supersedes: 2100-254D
File: Volume III, Tab 18
Date: 10-21-10

CONTENTS

General Information

- Description of Equipment 3
- Nomenclature 3
- Important 8
- Shipping Damage 8
- Unpacking Electric Heat Package 8
- Wiring Main Power 8

Installation

- Installation of Heater Package 10

Tables

- Table 1A Heater Usage by Model Matrix 3
- Table 1B Heater Usage by Model Matrix 4
- Table 1C Heater Usage by Model Matrix 4
- Table 1D Heater Usage by Model Matrix 5
- Table 1E Heater Usage by Model Matrix 6
- Table 1F Heater Usage by Model Matrix 6
- Table 2 Electrical Data and BTU Output 7
- Table 3 Terminal and Screw Mounting 12

Figures

- Figure 1 Electrical Connections 9
- Figure 2 Installation of Heater Package 11
- Figure 3 Rod Support & Screw Mounting 13
- Figure 4A - 4D Terminal Identification 14
- Figure 4E - 4F Terminal Identification 15
- Figure 5 Wiring Directions 16
- Figure 6 Marking Serial Plate 17

GENERAL INFORMATION

DESCRIPTION OF EQUIPMENT

The EHWA and EHWH series electric heater packages are field installable heater packages suitable for use with Bard wall mount hi boy air conditioners and heat pumps. The packages consist of the electric heat strip, the heater control base which includes the heat contactors, and circuit breaker or pull disconnects, installation instructions and wiring diagrams. See Table 1 for nominal electrical data and BTU output. Before installation, check unit serial plate to insure the heater package model that you intend to install is listed as a heater package that is suitable for use with the Bard wall mount hi boy unit. See Figure 6.

NOMENCLATURE

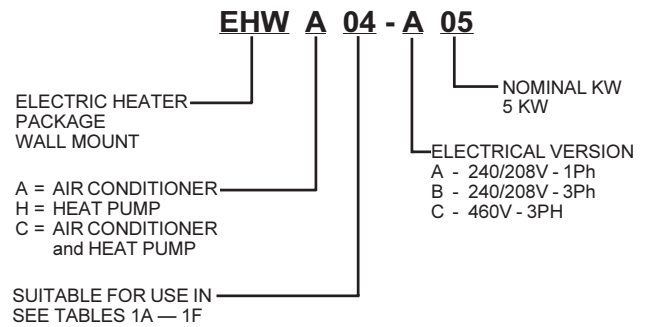

**TABLE 1A
R-22 HEATER USAGE BY MODEL MATRIX**

230/208V 1 Phase	WA423-A	WA424DA	WA484-A	WA484DA	WA484HA	WA6023A	WA602-A	WA602HA	WA603DA	WA7023A	WA702-A	WA702HA	WH421-A	WH421DA	WH483-A	WH483DA	WH483LA	WH602-2	WH602DA	WH602LA	
EHWA05-A05	X	X	X	X			X														
EHWA05-A10	X	X	X	X		X	X		X	X	X						X				X
EHWA05-A15	X		X				X				X										
EHWA05-A20	X		X				X				X										
EHWA60-A05											X										
EHWH04-A04															X						
EHWH04-A05																		X	X		
EHWH04-A10					X			X				X						X	X		
EHWH04-A15																		X			
EHWH04-A20															X			X			
EHWH42-A05													X	X	X	X					
EHWH42-A10													X	X	X	X					
EHWH42-A15													X		X						

WARNING

Only use factory provided heaters in approved combinations of heater models to unit models as shown in tables 1A — 1F. Failure to use approved combinations as shown or modification to heaters could result in fire causing damage, bodily injury or death.

**TABLE 1B
R-22 HEATER USAGE BY MODEL MATRIX**

240/220 V 2308208 V 3 Phase	EHWA05-B09	X	WA423-B	X	WA423-B	X	WA423-E	X	WA484-B	X	WA484-D	X	WA484-E	X	WA484-H	X	WA484-T	X	WA6023-B	X	WA602-B	X	WA602-E	X	WA602-H	X	WA602-T	X	WA603-D	X	WA7013-B	X	WA701-B	X	WA701-H	X	WA721-B	X	WA421-B	X	WA421-D	X	WA421-L	X	WA483-L	X	WA602-L	X
	EHWA05-B15	X	WA423-D	X	WA484-B	X	WA484-D	X	WA484-H	X	WA484-T	X	WA6023-B	X	WA602-B	X	WA602-E	X	WA602-H	X	WA602-T	X	WA603-D	X	WA7013-B	X	WA701-B	X	WA701-H	X	WA721-B	X	WA421-B	X	WA421-D	X	WA421-L	X	WA483-L	X	WA602-L	X	WA602-D	X	WA602-B	X	WA602-L	X
	EHWA05-B18	X	WA423-D	X	WA484-B	X	WA484-D	X	WA484-H	X	WA484-T	X	WA6023-B	X	WA602-B	X	WA602-E	X	WA602-H	X	WA602-T	X	WA603-D	X	WA7013-B	X	WA701-B	X	WA701-H	X	WA721-B	X	WA421-B	X	WA421-D	X	WA421-L	X	WA483-L	X	WA602-L	X	WA602-D	X	WA602-B	X	WA602-L	X
	EHWA60-B09		WA423-D		WA484-B		WA484-D		WA484-H		WA484-T		WA6023-B	X	WA602-B	X	WA602-E		WA602-H		WA602-T	X	WA603-D	X	WA7013-B	X	WA701-B	X	WA701-H	X	WA721-B	X	WA421-B		WA421-D		WA421-L		WA483-L		WA602-L		WA602-D		WA602-B	X	WA602-L	
	EHWH04-B18		WA423-D		WA484-B		WA484-D		WA484-H		WA484-T		WA6023-B		WA602-B		WA602-E		WA602-H	X	WA602-T		WA603-D		WA7013-B		WA701-B		WA701-H		WA721-B		WA421-B		WA421-D		WA421-L		WA483-L		WA602-L		WA602-D		WA602-B	X	WA602-L	
	EHWH05-B09		WA423-D		WA484-B		WA484-D		WA484-H	X	WA484-T		WA6023-B		WA602-B		WA602-E		WA602-H		WA602-T		WA603-D		WA7013-B		WA701-B		WA701-H		WA721-B		WA421-B		WA421-D		WA421-L		WA483-L		WA602-L		WA602-D		WA602-B	X	WA602-L	
	EHWH05-B15		WA423-D		WA484-B		WA484-D		WA484-H	X	WA484-T		WA6023-B		WA602-B		WA602-E		WA602-H		WA602-T		WA603-D		WA7013-B		WA701-B		WA701-H		WA721-B		WA421-B		WA421-D		WA421-L		WA483-L		WA602-L		WA602-D		WA602-B	X	WA602-L	

**TABLE 1C
R-22 HEATER USAGE BY MODEL MATRIX**

414 V 460 V 3 Phase	EHWA05A-C09		SH381-C	X	WA423-C	X	WA484-C	X	WA484-D	X	WA484-F	X	WA484-H	X	WA491-C	X	WA602-C	X	WA602-F	X	WA602-H	X	WA603-D	X	WA611-C	X	WA701-C	X	WA101-F	X	WA701-H	X	WA721-C	X	WE421-F	X	WE482-F	X	WE602-F	X	WE701-F	X	WH381-D	X	WH421-C	X	WH421-D	X	WH421-L	X	WH483-C	X	WH483-D	X	WH483-L	X	WH602-C	X	WH602-D	X	WH602-L	X
	EHWA05A-C15		SH431-C	X	WA423-C	X	WA484-C	X	WA484-D	X	WA484-F	X	WA484-H	X	WA491-C	X	WA602-C	X	WA602-F	X	WA602-H	X	WA603-D	X	WA611-C	X	WA701-C	X	WA101-F	X	WA701-H	X	WA721-C	X	WE421-F	X	WE482-F	X	WE602-F	X	WE701-F	X	WH381-D	X	WH421-C	X	WH421-D	X	WH421-L	X	WH483-C	X	WH483-D	X	WH483-L	X	WH602-C	X	WH602-D	X	WH602-L	X
	EHWH05A-C09		SH491-C	X	WA423-C	X	WA484-C	X	WA484-D	X	WA484-F	X	WA484-H	X	WA491-C	X	WA602-C	X	WA602-F	X	WA602-H	X	WA603-D	X	WA611-C	X	WA701-C	X	WA101-F	X	WA701-H	X	WA721-C	X	WE421-F	X	WE482-F	X	WE602-F	X	WE701-F	X	WH381-D	X	WH421-C	X	WH421-D	X	WH421-L	X	WH483-C	X	WH483-D	X	WH483-L	X	WH602-C	X	WH602-D	X	WH602-L	X
	EHWH05A-C15		SH611-C	X	WA423-C	X	WA484-C	X	WA484-D	X	WA484-F	X	WA484-H	X	WA491-C	X	WA602-C	X	WA602-F	X	WA602-H	X	WA603-D	X	WA611-C	X	WA701-C	X	WA101-F	X	WA701-H	X	WA721-C	X	WE421-F	X	WE482-F	X	WE602-F	X	WE701-F	X	WH381-D	X	WH421-C	X	WH421-D	X	WH421-L	X	WH483-C	X	WH483-D	X	WH483-L	X	WH602-C	X	WH602-D	X	WH602-L	X
	EHWH42-C06		SH381-C	X	WA423-C	X	WA484-C	X	WA484-D	X	WA484-F	X	WA484-H	X	WA491-C	X	WA602-C	X	WA602-F	X	WA602-H	X	WA603-D	X	WA611-C	X	WA701-C	X	WA101-F	X	WA701-H	X	WA721-C	X	WE421-F	X	WE482-F	X	WE602-F	X	WE701-F	X	WH381-D	X	WH421-C	X	WH421-D	X	WH421-L	X	WH483-C	X	WH483-D	X	WH483-L	X	WH602-C	X	WH602-D	X	WH602-L	X

**TABLE 1D
R-410A HEATER USAGE BY MODEL MATRIX**

230/208V 1 Phase	W42A1-A	W42A1DA	W48A1-A	W48A1DA	W60A1-A	W60A1DA	W60A13A	W70A1-A	W42H1-A	W42H1DA	W48H1-A	W48H1DA	W60H1-A	W60H1DA	W5RV1-R
EHWA05-A05	X	X	X	X		X									
EHWA05-A10	X	X	X	X	X	X	X	X							
EHWA05-A15	X		X		X			X							
EHWA05-A20	X		X		X			X							
EHWA05HA20															X
EHWH04-A04									X		X				
EHWH04-A05													X	X	
EHWH04-A10													X	X	X
EHWH04-A15													X		
EHWH04-A20											X		X		
EHWH42-A05									X	X	X	X			
EHWH42-A10									X	X	X	X			
EHWH42-A15									X		X				
EHWA60-A05					X			X							

**TABLE 1E
R-410 AHEATER USAGE BY MODEL MATRIX**

240/220 V 2308208 V 3 Phase	W42A1-B	W42A1DB	W42A1-E	W48A1-B	W48A1DB	W48A1-E	W60A1-B	W60A1DB	W60A1-E	W70A1-B	W42H1-B	W42H1DB	W48H1-B	W48H1DB	W60H1-B	W60H1DB	W5RV1-S	W6RV1-S
	EHW05A-B18	X	X		X	X		X	X									
EHW05H-B18													X		X			
EHW60A-B09							X											
EHW70A-B09										X								
EHW70AHB09																		X
EHW70A-B18										X							X	
EHW70AHB18																		X
EHWA05-B09	X	X	X	X	X	X			X									
EHWA05-B15	X		X	X		X	X	X		X								
EHWA05-B18									X									
EHWA60-B09								X										
EHWH05-B06											X	X	X	X				
EHWH05-B09											X	X	X	X	X	X	X	
EHWH05-B15											X		X		X			

**TABLE 1F
R-410A HEATER USAGE BY MODEL MATRIX**

414 V 460 V 3 Phase	W42A1-C	W42A1DC	W42A1-F	W48A1-C	W48A1DC	W48A1-F	W60A1-C	W60A1DC	W60A1-F	W70A1-C	W70A1-P	W42H1-C	W42H1DC	W48H1-C	W48H1DC	W60H1-C	W60H1DC	W5RV1-T	W6RV1-T
	EHWA05A-C09	X	X	X	X	X	X	X	X	X	X	X							
EHWA05A-C15	X			X			X			X									
EHWA05A-F14			X			X			X		X								
EHWH05A-C09												X	X	X	X	X	X	X	X
EHWH05A-C15												X		X		X		X	X
EHWH42-C06												X	X		X				

**TABLE 2
ELECTRICAL DATA AND BTU OUTPUT**

Heater Package Model	Volts	Phase	Nominal KW	Nominal BTU
EHWA05-A05	240/208	1	5 / 3.75	17,065 / 12,800
EHWA05-A10	240/208	1	10 / 7.5	34,130 / 25,600
EHWA05-A15	240/208	1	15 / 11.25	51,200 / 38,400
EHWA05-A20	240/208	1	20 / 15	68,260 / 51,200
EHWA05-B09	240/208	3	9 / 6.75	30,600 / 23,030
EHW60A-B09	240/208	3	9 / 6.75	30,600 / 23,030
EHW70A-B09	240/208	3	9 / 6.75	30,600 / 23,030
EHW70A-B18	240/208	3	18 / 13.5	30,600 / 23,030
EHWA05-B15	240/208	3	15 / 11.25	51,200 / 38,400
EHWA05-B18	240/208	3	18 / 13.5	61,430 / 46,100
EHW05A-B18	240/208	3	18 / 13.5	61,430 / 46,100
EHW05H-B18	240/208	3	18 / 13.5	61,430 / 46,100
EHWA05A-C09	480	3	9	30,700
EHWA05A-C15	480	3	15	47,000
EHWA60-A05	240/208	1	5 / 3.75	17,065 / 12,800
EHWA60-B09	240/208	3	9 / 6.75	30,600 / 23,030
EHWH42-A05	240/208	1	5 / 3.75	17,065 / 12,800
EHWH42-A10	240/208	1	10 / 7.5	34,130 / 25,600
EHWH42-A15	240/208	1	15 / 11.25	51,200 / 38,400
EHWH42-C06	480	3	6	20,475
EHWH04-A04	240/208	1	4 / 3	13,650 / 10,240
EHWH04-A05	240/208	1	5 / 3.75	17,065 / 12,800
EHWH04-A10	240/208	1	10 / 7.5	34,130 / 25,600
EHWH04-A15	240/208	1	15 / 11.25	51,200 / 38,400
EHWH04-A20	240/208	1	20 / 15	68,260 / 51,200
EHWH04-B18	240/208	3	18 / 13.5	61,430 / 46,100
EHWH05-B09	240/208	3	9 / 6.75	30,600 / 23,030
EHWH05-B15	240/208	3	15 / 11.25	51,200 / 38,400
EHWH05A-C09	480	3	9	30,700
EHWH05A-C15	480	3	15	47,000
EHWH05-B06	240/208	3	6 / 4.5	20,475 / 15,356

IMPORTANT

The equipment covered in this manual is to be installed by trained, experienced service and installation technicians.

SHIPPING DAMAGE

Upon receipt of equipment, the carton should be checked for external signs of shipping damage. If damage is found, the receiving party must contact the last carrier immediately, preferably in writing, requesting inspection by the carrier's agent.

UNPACKING ELECTRIC HEAT PACKAGE

Remove the heat package from the shipping carton. The heat package must consist of the following:

1. Basic heater.
2. Electric heat control base and wiring.
3. Installation instructions.
4. Wiring diagram (2), one to be applied to unit.
5. Adhesive label to remark serial plate to indicate new model number. This is attached to the front of these instructions.

WIRING MAIN POWER

1. On all installations, size unit power supply wiring for the minimum circuit ampacity requirement for the unit and heater package combination listed on the unit serial plate.

For existing installations, addition or upgrading of a heater package may require that larger supply wires be run to the unit. Resize all power supply wires for the minimum circuit ampacity rating listed on the unit serial plate that is applicable for your combination of unit and heater package.

WARNING

Install properly sized power supply leads for the unit/heater combination minimum circuit ampacity as listed on the unit serial plate. Hazard of fire. Failure to install properly sized conductors could result in fire.

2. All heater packages covered by this manual are factory wired for a single supply circuit. The following heater packages are field convertible to a dual supply circuit if required or desired.

EHWA05-A15	EHWH04-A05
EHWA05-A20	EHWH04-A10
EHWH42-A05	EHWH04-A15
EHWH42-A10	EHWH04-A20
EHWH42-A15	

3. To convert the above heater packages to dual circuit configuration before installation, loosen 4 screws holding jumper bar in place. Remove jumper bar. Circuit A + B are now identified on the heater package. See Figure 1.

Wire should be sized to the minimum circuit ampacity as specified on the serial plates of units that accept these heater packages for circuits A + B.

FIGURE 1
ELECTRICAL CONNECTIONS

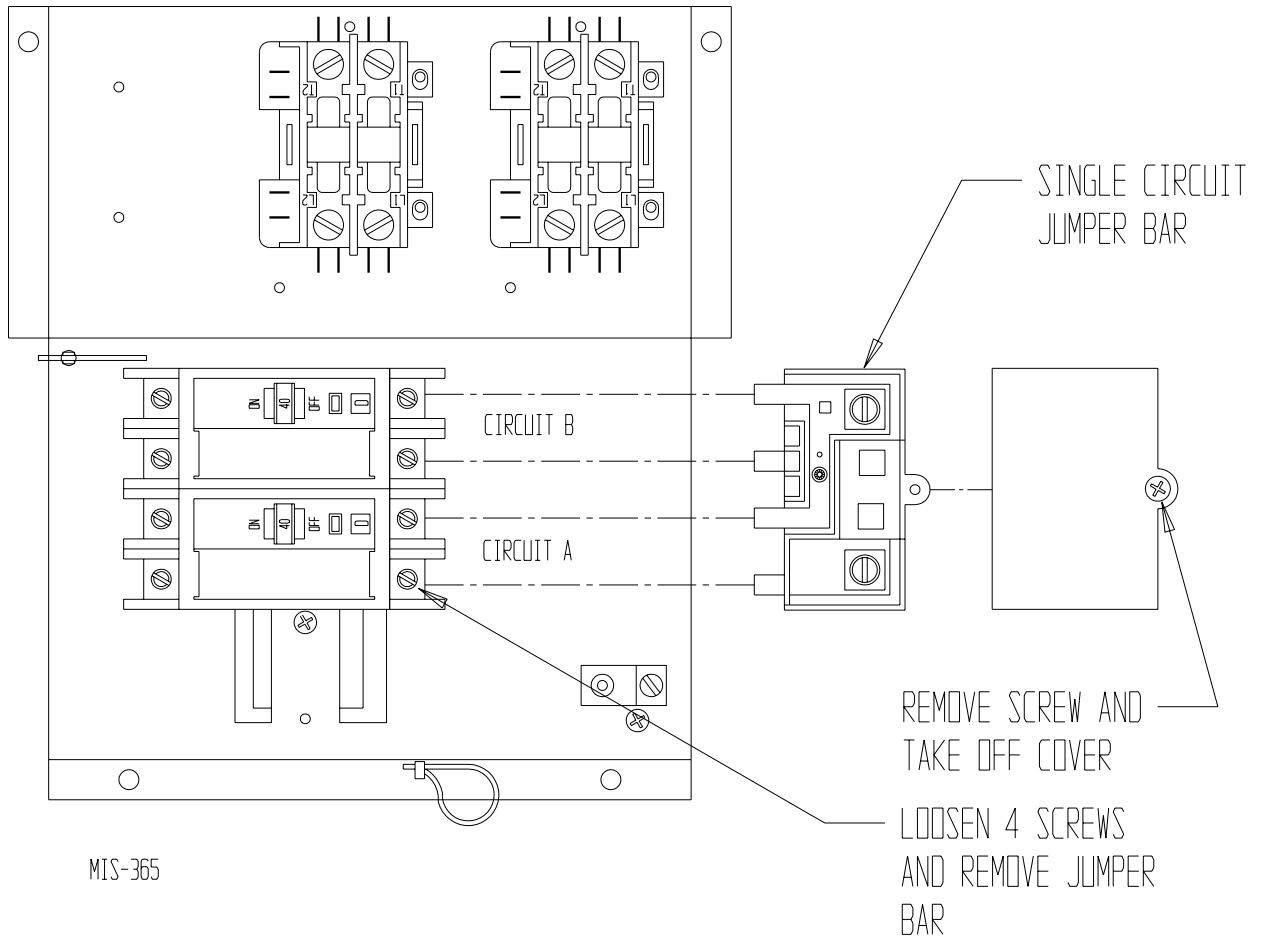

INSTALLATION OF HEATER PACKAGE

1. Disconnect all power to unit before installation.

WARNING

Disconnect all power to unit before installing heater package. Hazard of electrical shock. Failure to disconnect power could result in injury or death.

2. Before installation, check unit serial plate to insure that the heater package model that you intend to install is listed as a heater package suitable for use with the unit.

Under no circumstances shall a heater package be installed in a unit if the model number of the heater package does not appear on the unit serial plate.

WARNING

Install only heater packages listed on unit serial plate. Hazard of fire or electrical shock. Failure to install listed heater package could result in fire, injury or death.

3. Remove electric heater access panel and control panel cover, both inner and outer. See Figure 2.
4. All heaters are installed with the thermal cutoffs positioned to the top of the unit. Install heat strip(s) through heater access opening. Position heat strip support rod in heater support hole 1, 2 or 3 as indicated in Table 1 and Figure 3. Secure in place with 2 sheet metal screws in mounting holes as indicated in Table 1 and Figure 3. On heater packages with 2 heat strips, install 9KW or 10KW heater first in position closest to the outlet air frame. See Figures 4E and 4F.

5. Install heater control base into top of control panel as shown in Figure 5. Secure with 4 sheet metal screws provided.
6. Plug male 6 pin connector into mating connector mounted in control panel. See Figure 5.
7. Connect red compressor supply lead to L1 of terminal block. Connect black compressor supply lead to L2 of terminal block. If 3 phase, connect yellow supply lead to L3 of terminal block. See Figure 5 and wiring diagram.
8. Route wires from heater control base up through raceway in top right corner of control panel to the heaters. See Figure 5.
9. Wire heater package per wiring diagram supplied with this heater package. All wires are stamped with wire numbers that correspond with terminal numbers on the wiring diagram and stamped numbers on the heat strip. Limit switch wires are terminated with insulated quick connect terminals. See Figure 4.
10. Attach adhesive wiring diagram directly above unit wiring diagram on inner control panel cover.
11. Recheck all wiring. Break out appropriate circuit breaker tabs on inner control panel cover to allow trip lever to protrude. Replace control panel and heater access panels
12. Resupply power to the unit and check for proper operation.
13. Remark serial plate with self-adhesive label attached to the front of this manual. See Figure 6.

FIGURE 2
INSTALLATION OF HEATER PACKAGE

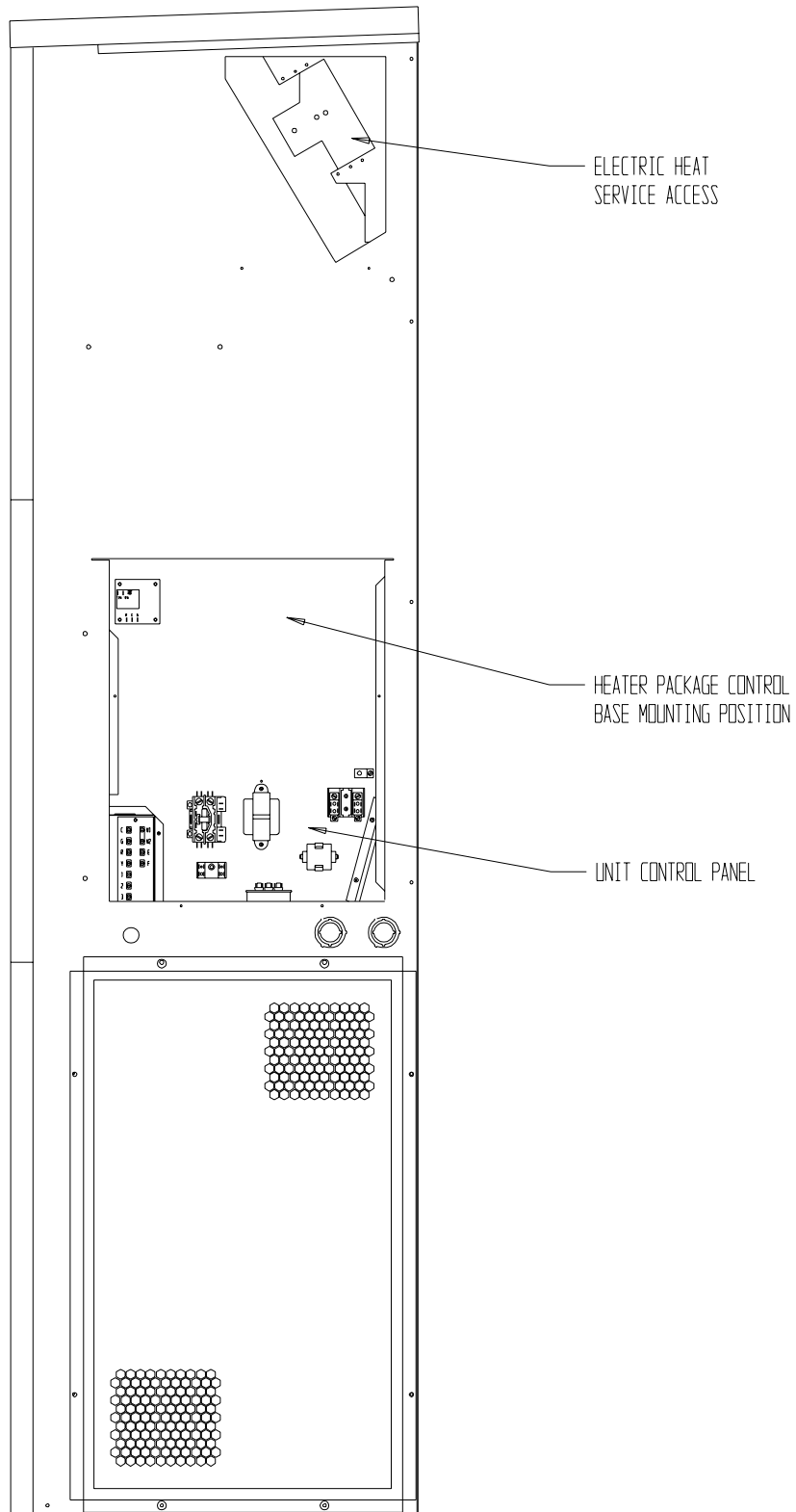

MIS-419

TABLE 3
REFER TO FIGURES 3 AND 4

	Heater Package Model Number	Figure 4 Heater Terminal Identification Drawing	Figure 3 Rod Support and Screw Mounting Position
1	EHWA05-A05	4A	1
2	EHWA05-A10	4B	1
3	EHWA05-A15	4D	1 + 3
4	EHWA05-A20	4F	1 + 3
5	EHWA05-B09	4C	1
6	EHWA05-B15	4E	1 + 3
7	EHWA05-B18	4E	1 + 3
8	EHWA05-C09	4C	1
9	EHWA05A-C15	4E	1 + 3
10	EHWA42-A05	4A	1
11	EHWA42-A10	4B	1
12	EHWA42-A15	4D	1 + 3
13	EHWA60-A05	4A	1
14	EHWA60-B09	4C	1
15	EHWH04-A04	4A	1
16	EHWH04-A05	4A	1
17	EHWH04-A10	4B	1
18	EHWH04-A15	4D	1 + 3
19	EHWH04-A20	4F	1 + 3
20	EHWH04-B09	4C	1
21	EHWH05-B15	4E	1 + 3
22	EHWH04-B18	4E	1 + 3
23	EHWH05A-C09	4C	1
24	EHWH05A-C15	4E	1 + 3
25	EHWH42-C06	4C	1
26	EHWH05-B06	4C	1
27	EHW05A-B18	4E	1 + 3
28	EHW05H-B18	4E	1 + 3
29	EHW60A-B09	4C	1
30	EHW70A-B09	4C	1
31	EHW70A-B18	4E	1 + 3

FIGURE 3
ROD SUPPORT AND SCREW MOUNTING POSITIONS

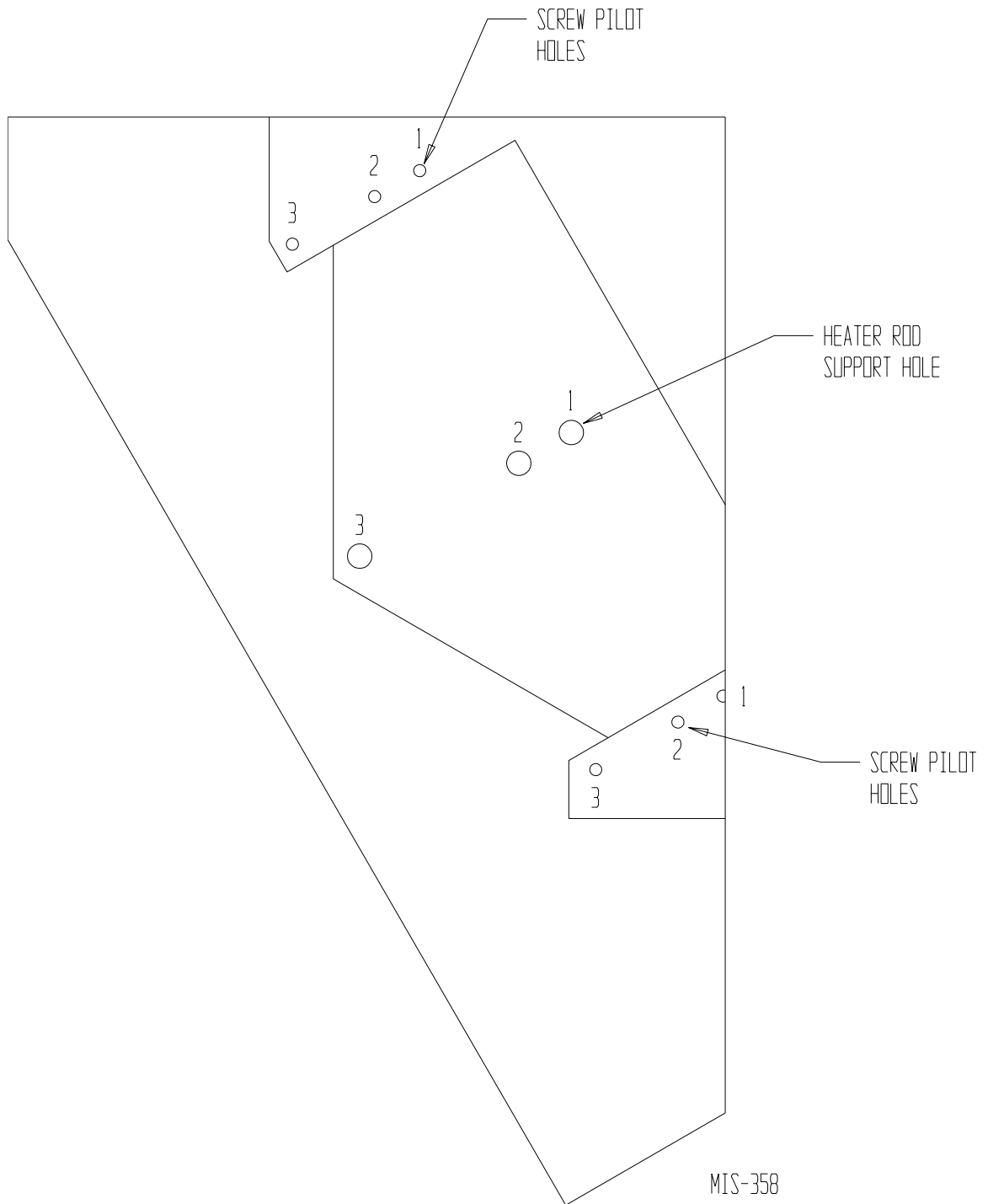

**FIGURES 4A - 4D
HEATER TERMINAL IDENTIFICATION DRAWINGS**

FIGURE 4A

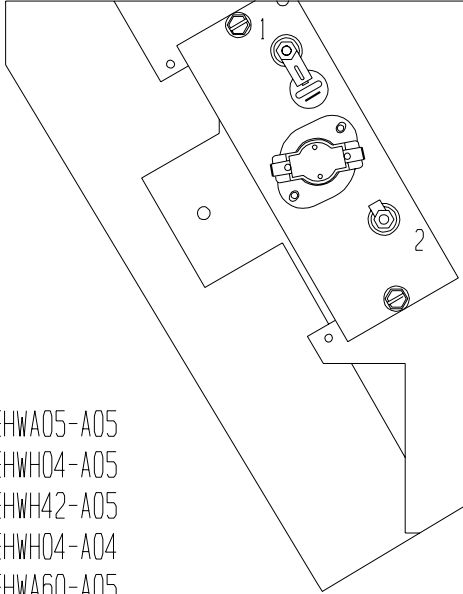

EHWA05-A05
 EHWH04-A05
 EWH42-A05
 EHWH04-A04
 EHWA60-A05

FIGURE 4C

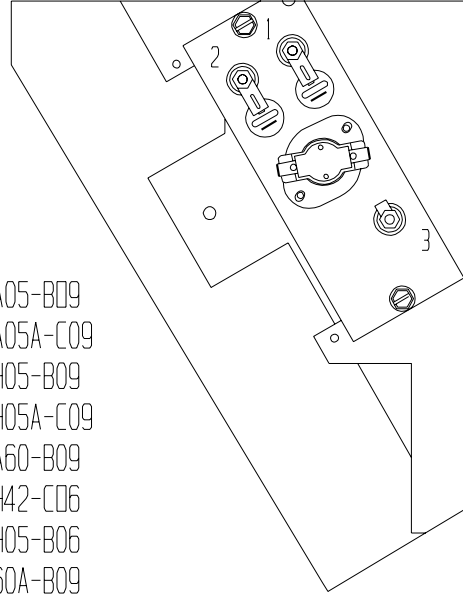

EHWA05-B09
 EHWA05A-C09
 EHWH05-B09
 EHWH05A-C09
 EHWA60-B09
 EWH42-C06
 EHWH05-B06
 EHW60A-B09
 EHW70A-B09

FIGURE 4B

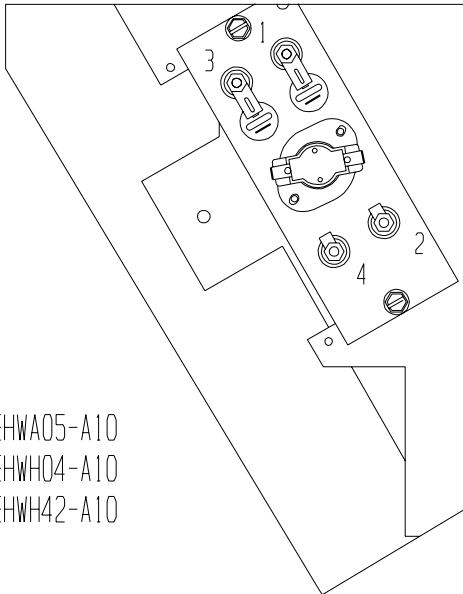

EHWA05-A10
 EHWH04-A10
 EWH42-A10

FIGURE 4D

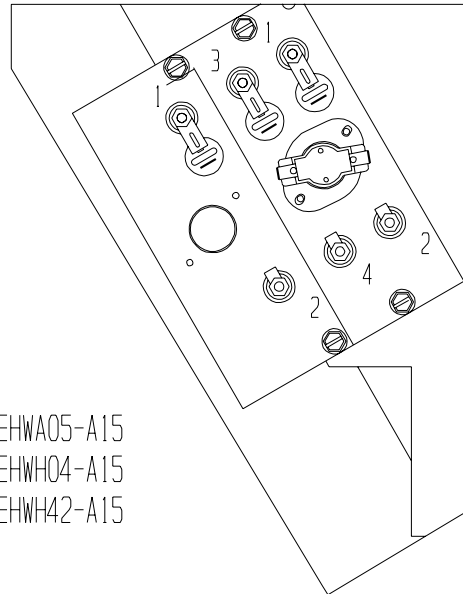

EHWA05-A15
 EHWH04-A15
 EWH42-A15

NOTE: THERMAL CUTOFFS TO BE AT
 TOP OF AIR FRAME WHEN INSTALLING.

MIS-420 A

**FIGURES 4E AND 4F
HEATER TERMINAL IDENTIFICATION DRAWINGS**

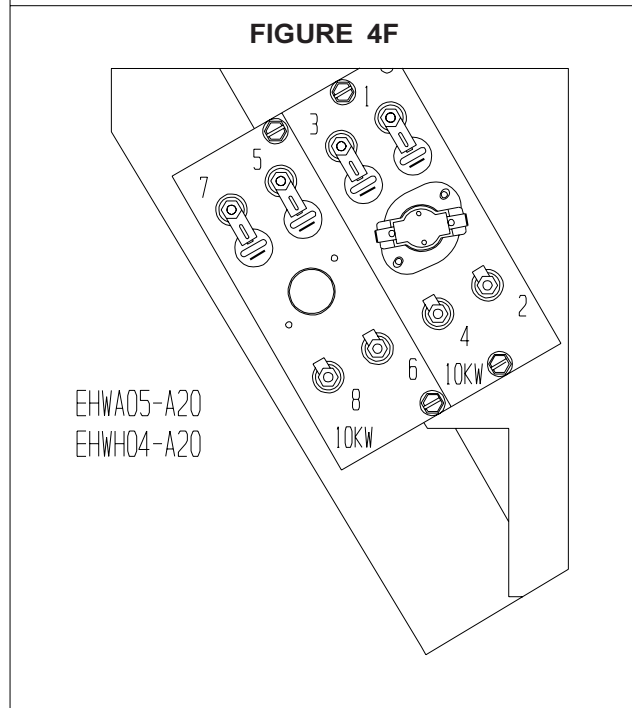
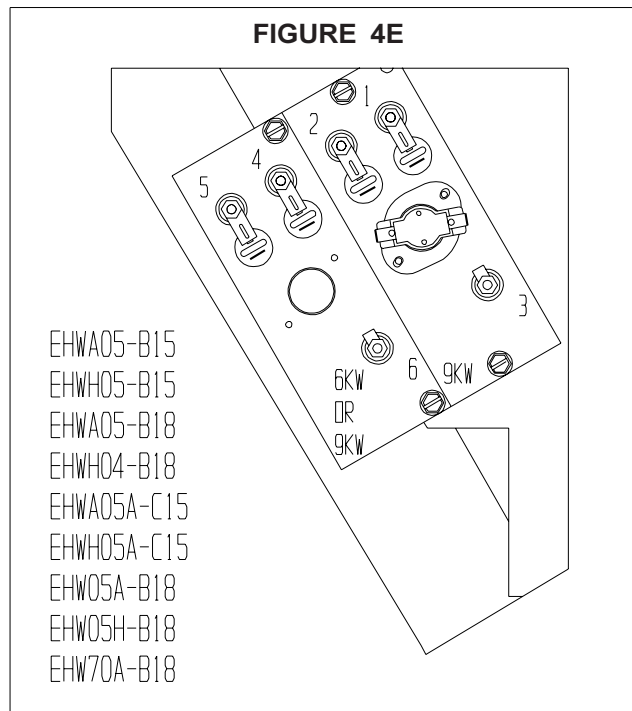

NOTE: THERMAL CUTOFFS TO BE AT
 TOP OF AIR FRAME WHEN INSTALLING.

MIS-421 A

**FIGURE 5
WIRING DIRECTIONS**

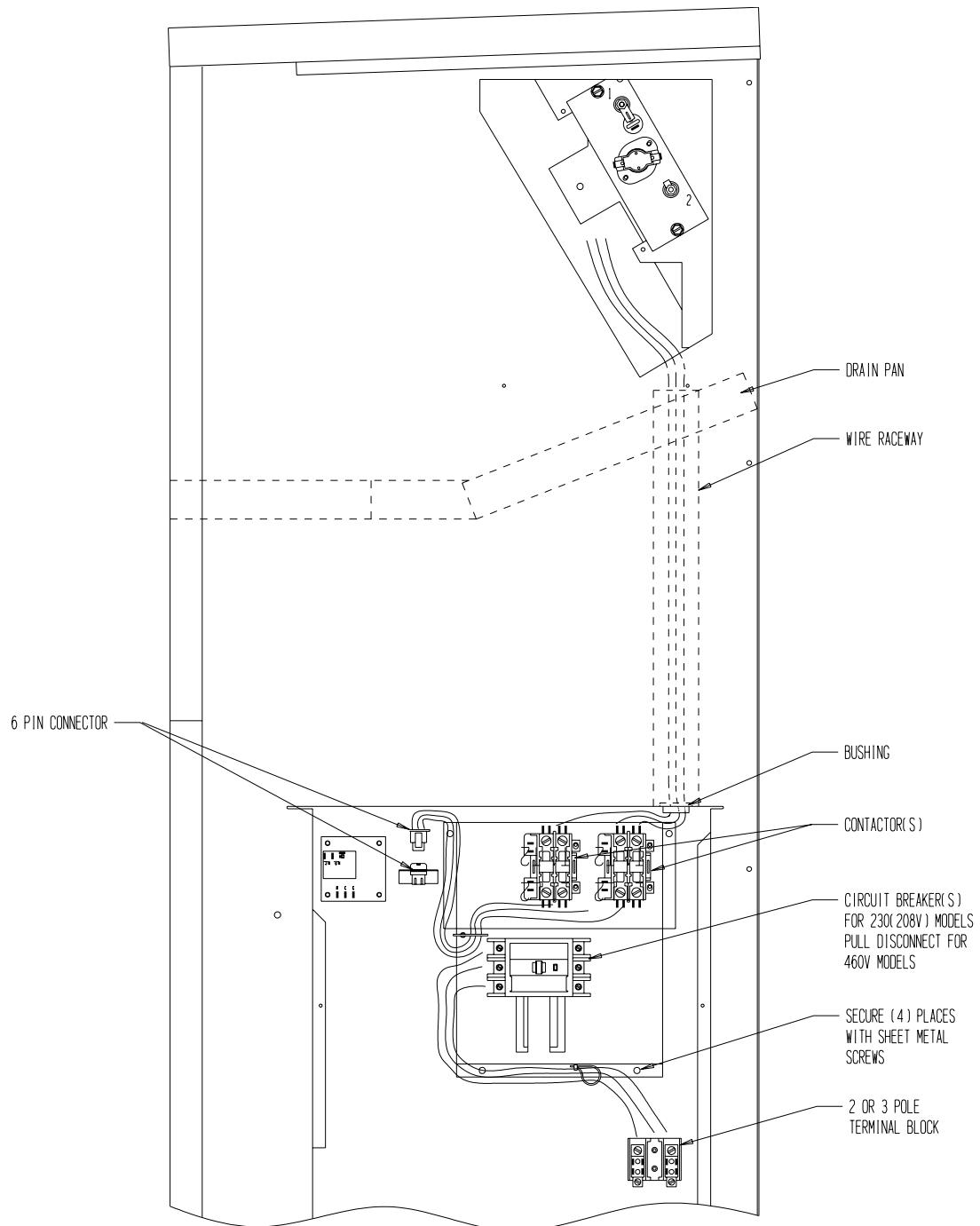

MIS-422

**FIGURE 6
MARKING SERIAL PLATE LABEL**

INSTALL ONLY HEATER PACKAGES LISTED HERE.

BARD MANUFACTURING COMPANY, 1914 RANDOLPH DRIVE

(x)	()	()	()	()	()
()	(x)	()	()	()	()
()	()	(x)	()	()	()
()	()	()	(x)	()	()
()	()	()	()	(x)	()

(1)
APPROVED
HEATER
PACKAGE

MODEL	VAC	HZ
() JWA361-A0012345	230/208	60
() JWA361-A0512345	230/208	60
(x) JWA361-A0812345	230/208	60
() JWA361-A1012345	230/208	60
() JWA361-A1512345	230/208	60

BRANCH CIRCUIT SELECT CURRENT 17 OPERATION

SERIAL NUMBER 125H920711193-01 UL FILE NO.

SUITABLE FOR OUTDOOR USE

COMPRESSOR	VAC	HZ	PH	HP	ELECTRICAL
OUTDOOR MOTOR	230/208	60	1	1	1/5
INDOOR MOTOR	230/208	60	1	1	1/3
HEATER PACKAGE					KW
EHWA03-A05	240/208	60	1	1	5/3.75
EHWA03-A08	240/208	60	1	1	8/6
EHWA03-A10	240/208	60	1	1	10/7.5
EHWA03-A15	240/208	60	1	1	15/11.25

-- FACTORY

FACTORY CHARGED R22: 68 OZ. DESI

-- CLEAR

ASSURE THAT SERIAL PLATE IS CLEAN AND DRY, REMOVE APPROPRIATE LABEL STRIP FOR KW REQUIRED AND REMARK SERIAL PLATE AS SHOWN FOR THE HEATER PACKAGE THAT IS INSTALLED