

# **INSTALLATION INSTRUCTIONS**

## **HIGH EFFICIENCY PACKAGED AIR CONDITIONER**

### **MODELS**

**P1024A1**

**P1030A1**

**P1036A1**

**FOR RESIDENTIAL AND COMMERCIAL  
HEATING/COOLING APPLICATIONS**

MANUAL: 2100-127 REV. F  
SUPERSEDES: REV. E  
FILE: Vol. II, Tab 10  
DATE: 03-27-95

TABLE OF CONTENTS

Important . . . . .	3
Shipping Damage . . . . .	3
General . . . . .	3
Installation . . . . .	3
Location . . . . .	3
Typical Installation . . . . .	3
Wiring--Main Power . . . . .	4
Pressure Service Ports . . . . .	5
Air Filters . . . . .	5
Refrigerant Charge . . . . .	5
Crankcase Heaters . . . . .	6
Fan Blade Setting Dimensions . . . . .	7
Important Installer Notes . . . . .	7
Optional Electric Heaters . . . . .	7
Prefabricated Roof Curb Specifications . . . . .	9

FIGURES AND TABLES

Figure 1 . . . . .	6
Figure 2 . . . . .	7
Figure 3 . . . . .	8
Figure 4 . . . . .	8
Figure 5 . . . . .	8
Figure 6 . . . . .	8
Figure 7 . . . . .	9
Figure 7 . . . . .	9
Table 1 . . . . .	1
Table 2 . . . . .	1
Table 3 . . . . .	2
Table 4 . . . . .	4
Table 5 . . . . .	5
Table 6 . . . . .	5
Table 7 . . . . .	10

TABLE 1  
ELECTRICAL DATA

Model	Rated Volts & PH	Operating Voltage Range	Max. Unit Amps	Req'd. Maximum External Fuses Or Ckt. Brk *	Minimum Circuit Ampacity	Field Power Wiring**	Ground Wire Size**
				Ckt. A	Ckt. A	Ckt. A	Ckt. A
P1024A	230/208-1	197-253	12.8	25	18	12	12
P1030A	230/208-1	197-253	18.2	35	23	10	10
P1036A	230/208-1	197-253	20.2	40	25	10	10

\*Maximum time delay fuse or HACR type circuit breaker.

\*\*60 degree C copper wire size, basic unit only.

TABLE 2  
OPTIONAL FIELD INSTALLED HEATER PACKAGES  
ARE ONLY TO BE USED WITH THE  
AIR CONDITIONING MODEL AS INDICATED BELOW

Heater Package Model No.	Volts and Phase	P1024A	P1030A	P1036A
EH3PB-A05	240/1	S	S	S
EH3PB-A08		S	S	S
EH3PB-A10		S	S	S
EH3PB-A15		S	S	S
EH3PB-B09	240/3	A	A	A
EH3PB-B15		A	A	A

S Standard application--Heater volts and phase same as basic unit.

A Alternate application--Heater volts and phase different from basic unit.

**TABLE 3**  
**OPTIONAL FIELD-INSTALLED ELECTRIC HEATER TABLE**

Heater Pkg. Model No.	Unit Volts Phase	Htr. KW & Cap. @240V (or 480V if applicable)		Heater KW & Capacity @208 Volts		@240V or 480V as Applicable Htr. Amps	Heater Internal Fuses	Circuit B				
		KW	BTUH	KW	BTUH			No. Field Ckts.	Minimum Circuit Ampacity	(1) Maximum Overcurrent Protection	(2) Field Power Wiring	(3) Ground Wire Size
EH3PB-A05	240/208-1	5	17,100	3.75	12,800	20.8		1	26	30	10	10
EH3PB-A08	240/208-1	8	27,300	6	20,500	33.3		1	42	45	8	10
EH3PB-A10	240/208-1	10	34,100	7.5	26,000	41.7		1	53	60	6	10
EH3PB-A15	240/208-1	15	51,200	11.25	38,400	62.5	30/60	1	79	80	4	8
EH3PB-B09	240/208-3	9	30,700	6.75	23,000	21.7		1	28	30	10	10
EH3PB-B15	240/208-3	15	51,200	11.25	38,400	36.2		1	46	50	8	10

- (1) Time delay fuses or "HACR Type" circuit breakers must be used for 60 and smaller sizes. Standard fuses or circuit breakers are suitable for sizes 70 and larger. 480V circuit breakers are not "HACR Type".
- (2) Based on wire suitable for 75 degrees C. Other wiring materials must be rated for marked "Minimum Circuit Ampacity" or greater.
- (3) Based upon Table 250-95 of N.E.C. 1984. See electrical data for basic heat pump for Ckt. A wiring specification requirements.

**IMPORTANT:** While this electrical data is presented as a guide, it is important to electrically connect, properly size fuses and conductor wires in accordance with the National Electrical Code and all existing local codes.

## IMPORTANT

The equipment covered in this manual is to be installed by trained, experienced service and installation technicians. All duct work, supply and return, must be properly sized for the design air flow requirement of the equipment. ACCA is an excellent guide to proper sizing. All duct work or portions thereof not in the conditioned space should be properly insulated in order to both conserve energy and prevent condensation or moisture damage.

## SHIPPING DAMAGE

Upon receipt of equipment, the carton should be checked for external signs of shipping damage. If damage is found, the receiving party must contact the last carrier immediately, preferably in writing, requesting inspection by the carrier's agent.

## GENERAL

The refrigerant system is completely assembled and charged. All internal wiring is complete.

The unit is designed for use with or without duct work. Flanges are provided for attaching the supply and return ducts.

These instructions explain the recommended method to install the air cooled self-contained unit and the electrical wiring connections to the unit.

These instructions and any instructions packaged with any separate equipment required to make up the entire air conditioning system should be carefully read before beginning the installation. Note particularly "Starting Procedure" and any tags and/or labels attached to the equipment.

While these instructions are intended as a general recommended guide, they do not supersede any national and/or local codes in any way. Authorities having jurisdiction should be consulted before the installation is made.

## INSTALLATION

Size of unit for a proposed installation should be based on heat loss calculation made according to methods of National Warm Air Heating and Air Conditioning Association. The air duct should be installed in accordance with the Standards of the National Fire Protection Association for the Installation of Air Conditioning and Ventilating Systems of Other Than Residence Type, NFPA No. 90A, and Residence Type Warm Air Heating and Air Conditioning Systems, NFPA No. 90B. Where local regulations are at a variance with instructions, installer should adhere to local codes.

## LOCATION

The unit must be located outside, or in a well ventilated area. It must not be in the space being heated or cooled. A sound absorbing material should be considered if the unit is to be installed in such a position or location that might cause transmission of sound or vibration to the living area or adjacent buildings.

## TYPICAL INSTALLATION

1. **ROOF MOUNTED**--The unit is mounted on a sturdy base on the roof of the building. Return air to the unit is brought through a single return grille (grilles with built-in filters are best, since they enable easy access for filter changing). Return air ducts are attached to the lower section of the front panel. Supply air is brought from the unit to attic duct work or to a furred down hall. Supply air duct is attached to the top of the front panel. **CAUTION:** All outdoor duct work must be thoroughly insulated and weatherproofed. All attic duct work must be thoroughly insulated. One inch thick insulation with suitable vapor barrier is recommended for both outdoor and attic runs. In rooftop installations, as in all installations, the unit must be level from side to side. However, the unit should have a pitch along the length to assure complete external drainage of precipitation and of defrost condensate.

2. **CRAWL SPACE**--Duct work installed in crawl space must be well insulated and provided with a vapor barrier. In addition, the crawl space must be thoroughly ventilated and provided with a good vapor barrier as a ground cover. It is most desirable to install the unit outdoors, rather than inside the crawl space, so that it will be readily accessible for service. In addition, it is necessary to dispose of the condensate from the outdoor coil on the heating cycle, and this is virtually impossible with the unit installed inside the crawl space.
3. **SLAB MOUNTED AT GROUND LEVEL**--This type installation is ideal for homes with a slab floor construction, where a roof mounted unit is not desired. The supply and return duct work can be run through a furred closet space.
4. **THRU-THE-WALL**--This type installation requires a suitable framework to be fabricated capable of withstanding the unit weight. Normally the unit will be insulated so as to minimize supply and return duct work.
5. **OTHER INSTALLATIONS**--Many other installations are possible with the packaged air conditioner. No matter what the installation, always consider the following facts:
  - A. Insure that the discharge air is not obstructed in any way so as to cause operation difficulties.
  - B. The indoor coil drain pan is equipped with a coupling that must be piped through a condensate drain trap to a suitable drain.
  - C. Always mount the unit in such a position that it may be easily reached for servicing and maintenance.
  - D. Insure that the unit is clear so that proper air flow over the outdoor coil will be maintained.

TABLE 4

RATED CFM AND EXTERNAL STATIC PRESSURE (ESP) WET COIL (COOLING)			
Model	Rated CFM	Rated ESP	Recommended Air Flow Range
P1024A	800	.20	720 - 880 CFM
P10A30	1150	.35	1020 - 1275 CFM
P1036A	1275	.30	1150 - 1400 CFM

#### WIRING--MAIN POWER

Refer to the unit rating plate for wire sizing information and maximum fuse size or "HACR Type" circuit breaker size. Each outdoor unit is marked with a "Minimum Circuit Ampacity". This means that the field wiring used must be sized to carry that amount of current. If field installed heaters are added to the basic unit, a second, separate power supply circuit will be required. The heater rating plate located adjacent to the basic unit rating plate will show the appropriate circuit ampacity, fuse size, etc. (Also see "Electrical Data" on pages 1 and 2). Some models are suitable only for connection with copper wire, while others can be wired with either copper or aluminum wire. Each unit and/or wiring diagram will be marked "Use Copper Conductors Only" or "Use Copper or Aluminum Conductors". These instructions MUST BE adhered to. Refer to the National Electrical Code for complete current carrying capacity data on the various insulation grades of wiring material.

The electrical data lists fuse and wire sizes (60 degree F copper) for all models, including the most commonly used heater sizes. Also shown are the number of field power circuits required for the various models with heaters.

The unit rating plate lists a "Maximum Time Delay Fuse" or "BACR" type circuit breaker that is to be used with the equipment. The correct size must be used for proper circuit protection and also to assure that there will be no nuisance tripping due to the momentary high starting current of the compressor motor.

## PRESSURE SERVICE PORTS

High and low pressure service ports are installed on all units so that the system operating pressures can be observed. Pressure charts can be found later in the manual covering all models on both cooling and heating cycles. It is imperative to match the correct pressure table to the unit by model number.

## AIR FILTERS

Air filters for the return air side of the system are not provided as part of the basic piece of equipment because of various types of applications for these models, and must be field supplied and installed as part of the final installation.

Prior thought should be given to return air location and placement of the air filter(s). The air filter(s) must be of adequate size and readily accessible to the operator of the equipment. Filters must be adequate in size and properly maintained for proper operation. If this is not done, excessive energy use, poor performance, and multiple service problems will result. **IT IS IMPOSSIBLE TO OVERSIZE AIR FILTERS.** Generous sizing will result in cleaner air and coils, as well as lower operating costs and extend the time between required changes. The following table shows minimum filter areas and recommended filter sizes. Actual filter sizes can vary with the installation due to single or multiple returns utilizing a filter/grille arrangement or being placed immediately ahead of the indoor coil face in the return air duct.

TABLE 5

Model	Minimum Filter Areas	Recommended Size
P1024A, P1030A, P1036A	462 sq. in. (3.21 sq.ft.)	15 x 30-5/8 x 1

NOTE: If roof hood accessory is to be used, information on air filters may be found under that heading in this manual. Air filters are supplied as part of that package.

## REFRIGERANT CHARGE

The correct system R-22 charge is shown on the unit rating plate. Optimum unit performance will occur with a refrigerant charge resulting in a suction line temperature (6" from compressor) as shown in the following table:

TABLE 6

Model	Rated Airflow	95 Degree F OD Temperature	82 Degree F OD Temperature
P1024A	800	53 - 55	64 - 66
P1030A	1150	50 - 52	62 - 64
P1036A	1275	52 - 55	58 - 60

The above suction line temperatures are based upon 80 degree F dry bulb/67 degree F wet bulb (50 percent RH) temperature and rated airflow across the evaporator during cooling cycle.

## CRANKCASE HEATERS

All units are provided with compressor crankcase heat. The units have an insertion well-type heater located in the lower section of the compressor housing. This is a self-regulating type heater that draws only enough power to maintain the compressor at a safe temperature.

Some form of crankcase heat is essential to prevent liquid refrigerant from migrating to the compressor, causing oil pump out on compressor start-up and possible valve failure due to compressing a liquid.

The decal in Figure 1 is affixed to all outdoor units detailing start-up procedure. This is very important. Please read carefully.

FIGURE 1

**IMPORTANT**

**THESE PROCEDURES MUST BE FOLLOWED AT INITIAL START-UP AND AT ANY TIME POWER HAS BEEN REMOVED FOR 12 HOURS OR LONGER.**

TO PREVENT COMPRESSOR DAMAGE WHICH MAY RESULT FROM THE PRESENCE OF LIQUID REFRIGERANT IN THE COMPRESSOR CRANKCASE.

1. MAKE CERTAIN THE ROOM THERMOSTAT IS IN THE "OFF" POSITION. (THE COMPRESSOR IS NOT TO OPERATE).
2. APPLY POWER BY CLOSING THE SYSTEM DISCONNECT SWITCH. THIS ENERGIZES THE COMPRESSOR HEATER WHICH EVAPORATES THE LIQUID REFRIGERANT IN THE CRANKCASE.
3. ALLOW 4 HOURS OR 60 MINUTES PER POUND OF REFRIGERANT IN THE SYSTEM AS NOTED ON THE UNIT RATING PLATE, WHICHEVER IS GREATER.
4. AFTER PROPERLY ELAPSED TIME THE THERMOSTAT MAY BE SET TO OPERATE THE COMPRESSOR.
5. EXCEPT AS REQUIRED FOR SAFETY WHILE SERVICING — DO NOT OPEN SYSTEM DISCONNECT SWITCH.

7961-061



## FAN BLADE SETTING DIMENSIONS

Shown in the drawing below are the correct fan blade setting dimensions for proper air delivery across the outdoor coil.

Any service work requiring removal or adjustment in the fan and/or motor area will require that the dimensions below be checked and blade adjusted in or out on the motor shaft accordingly.

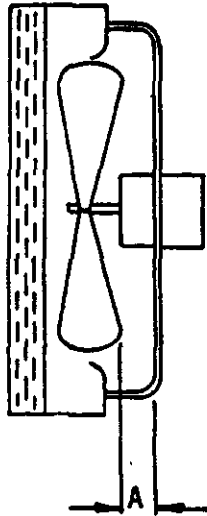

FIGURE 2

Model	Dimension A
P1024A1	1.00"
P1030A1	.75"
P1036A1	1.00"

### IMPORTANT INSTALLER NOTES

For improved start-up performance, wash the indoor coil with a dishwasher detergent.

### OPTIONAL ELECTRIC HEATERS

These packaged air conditioners are manufactured without supplementary electric heaters. Supplementary heaters BB3PB series (to fit P1024A, P1030A, and P1036A) are available for simple, fast field installation.

A separate field power circuit is required for the supplementary heaters.

Refer to the electrical data shown on pages 1 and 2 for proper application information on all available heater combinations and what units they can be used with. It also shows the applicable circuit ampacities, fuse size, and wire size for each heater combination.

Refer to the installation instructions packed with the heater for details on how to insert it into the basic unit.

If this unit is operated in cooling below a 65 degree outdoor ambient temperature, the installation of low ambient control (LAC-1) to unit is required.

Figure 3

ROOFTOP APPLICATION

(May also be required for ground level installations)

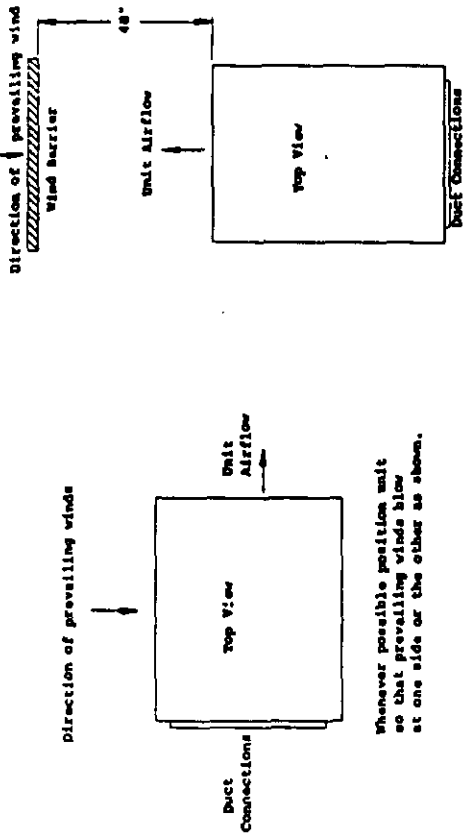

Figure 5

SLAB MOUNTING AT GROUND LEVEL  
(Above 32°F Outside Temperature)

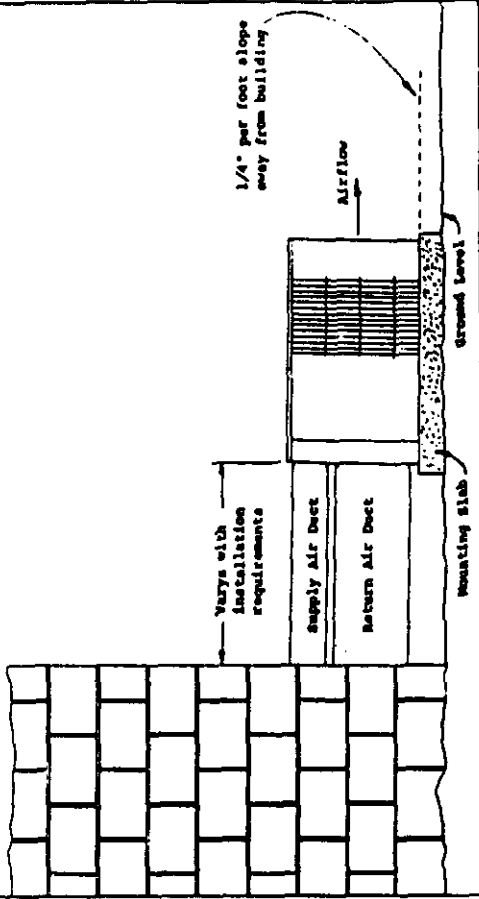

Figure 4

ELEVATED MOUNTING PLATFORMS

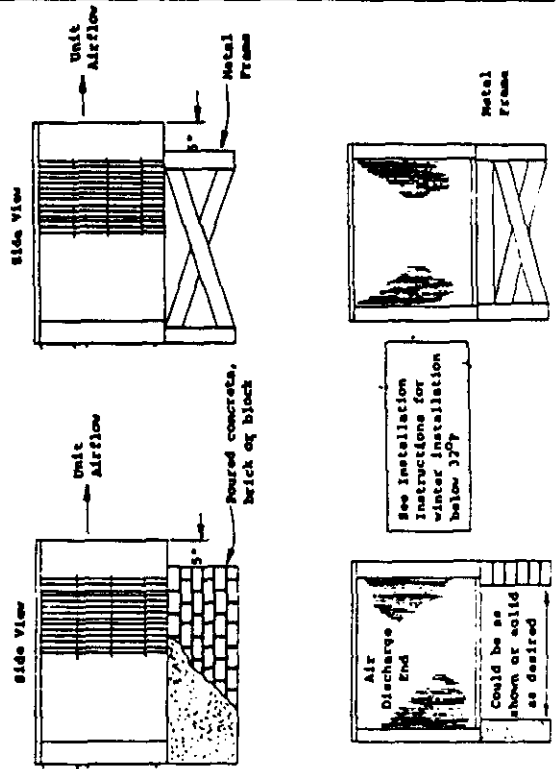
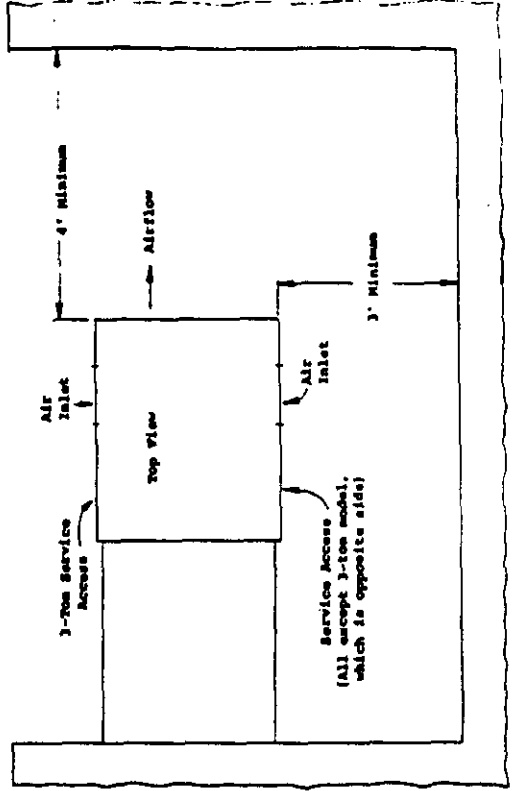

Figure 6

AIRFLOW AND SERVICE ACCESS CLEARANCES



**PREFABRICATED ROOF CURB SPECIFICATIONS**  
**HEAVY GAUGE GALVANIZED WITH WOOD NAILING STRIP, WELDED/LEAKPROOF**  
**ONE PIECE CONSTRUCTION--READY TO INSTALL**

FIGURE 7

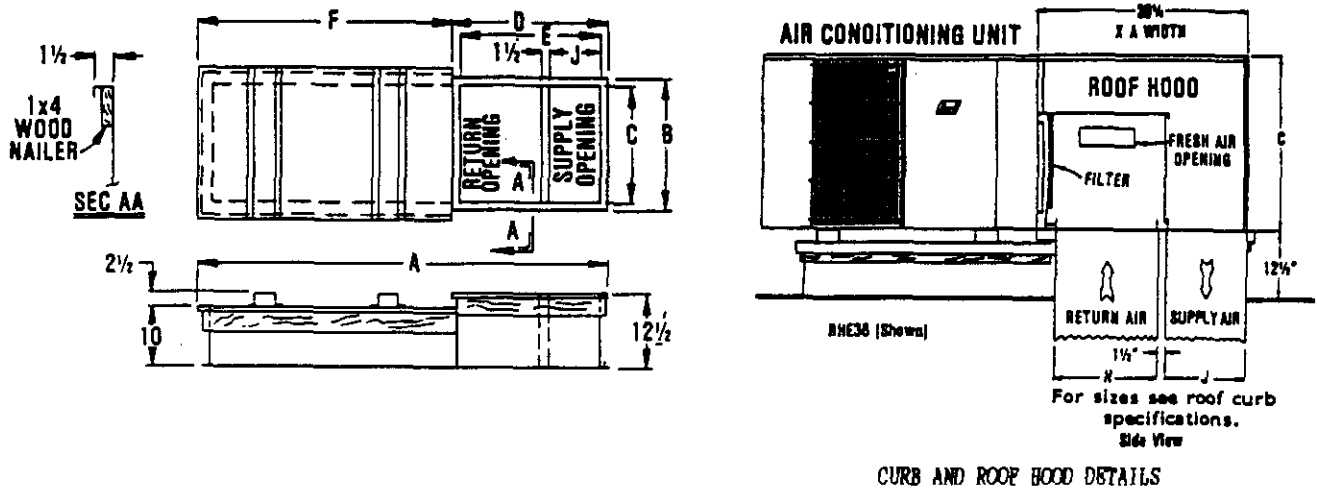

CURB AND ROOF HOOD DETAILS

Roof Curb	A	B	C*	D	E	F	J*	H*	Roof Hood Model	Heat Pump and Air Conditioning Units
9042-003	80-3/8	40-1/4	37-1/4	38-3/8	35-3/8	42	14-3/4	19-1/8	RHE36	P1024A, P1030A, P1036A

**\*Duct Sizing Information**

Return Air Dimension "C" is length  
 Return Air Dimension "H" is width

Supply Air Dimension "C" is length  
 Supply Air Dimension "J" is width

**FIELD FABRICATED CURBING**

FIGURE 8

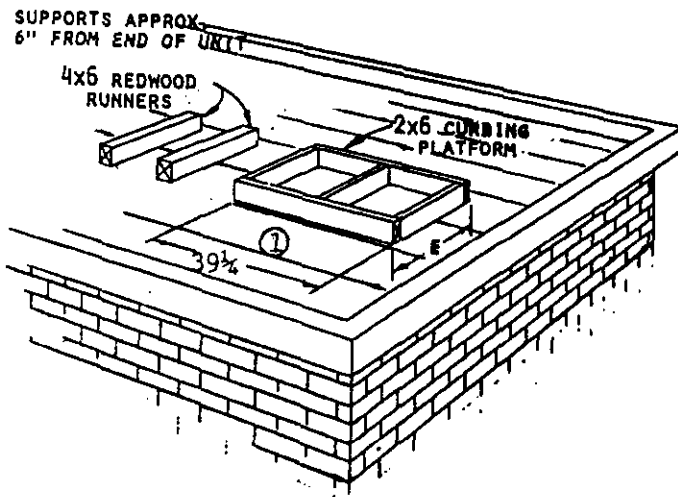

Roof Hood Model	Unit Model	E
RHE36	P1024A P1030A P1036A	41

① A separate metal flashing should be installed around wood curbing. Caulk and seal all joints and weatherproof.

TABLE 7

## COOLING

Air Temperature Entering Outdoor Coil Degree F

Model	Return Air Temperature	Pressure	°	°	°	°	°	°	°	°	°
			75	80	85	90	95	100	105	110	115
P1024A1	75 deg. DB	Low Side	71	73	75	77	79	81	82	84	86
	62 deg. WB	High Side	196	211	227	242	257	272	288	303	318
	80 deg. DB	Low Side	76	78	80	82	84	86	88	90	92
	67 deg. WB	High Side	202	216	233	249	264	280	295	311	326
	85 deg. DB	Low Side	82	84	86	88	90	92	95	97	99
P1030A1	72 deg. WB	High Side	209	225	241	257	273	289	305	321	337
	75 deg. DB	Low Side	71	73	74	75	77	78	79	81	82
	62 deg. WB	High Side	213	229	245	261	277	293	309	325	341
	80 deg. DB	Low Side	76	78	79	81	82	84	85	87	88
	67 deg. WB	High Side	218	235	251	268	284	301	317	334	350
P1036A1	85 deg. DB	Low Side	82	83	85	87	88	90	92	93	95
	72 deg. WB	High Side	226	243	260	277	294	311	328	345	362
	75 deg. DB	Low Side	68	70	72	74	77	78	80	82	84
	62 deg. WB	High Side	206	222	238	255	271	287	303	319	335
	80 deg. DB	Low Side	73	75	77	80	82	84	86	88	90
P1036A1	67 deg. WB	High Side	211	228	244	261	278	294	311	328	344
	85 deg. DB	Low Side	78	81	83	85	88	90	92	95	97
	72 deg. WB	High Side	218	236	253	270	288	305	322	339	356

Low side pressure  $\pm$  2 PSIGHigh side pressure  $\pm$  5 PSIG

Tables are based upon rated CFM (airflow) across the evaporator coil and should be found under section titled "Refrigerant Charge" elsewhere in manual. If there is any doubt as to correct operating charge being in the system, the charge should be removed, system evacuated, and recharged to serial plate instructions.

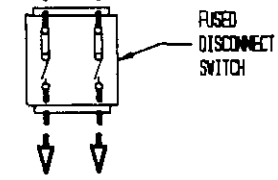
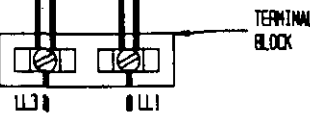
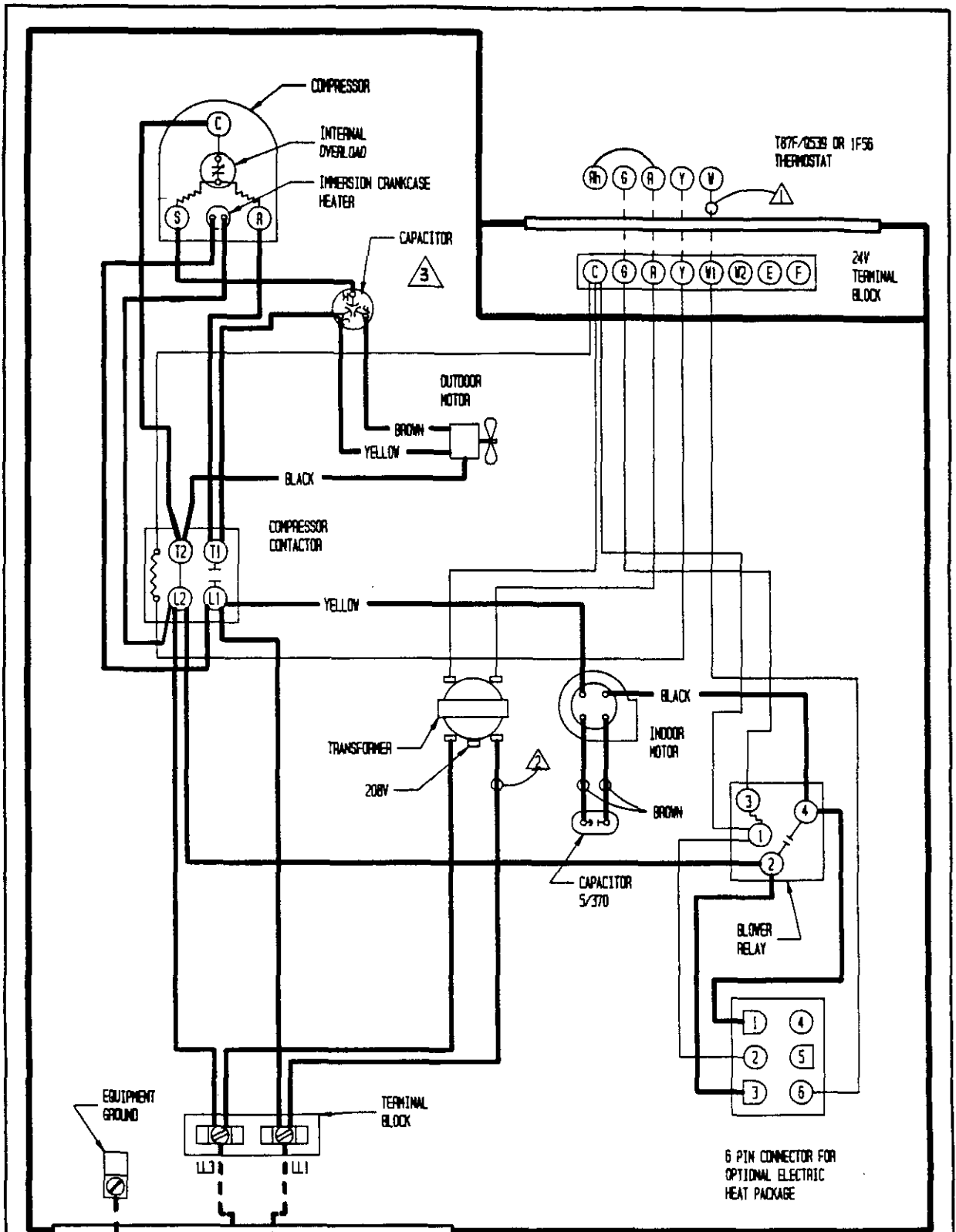

230/208V 60HZ 1-Φ

- ⚠ NOT REQUIRED WHEN OPTIONAL HEAT PACKAGES ARE NOT INSTALLED.
- ⚠ FOR 208V OPERATION MOVE THIS WIRE TO 208V TRANSFORMER TAP.

USE COPPER OR ALUMINUM WIRE

MODEL NO.	CAPACITOR
P25A1	35/5-370
P1024A1	25/5-370

	FACTORY WIRING	FIELD WIRING
LOW VOLTAGE	—————	- - - - -
HIGH VOLTAGE	—————	- - - - -

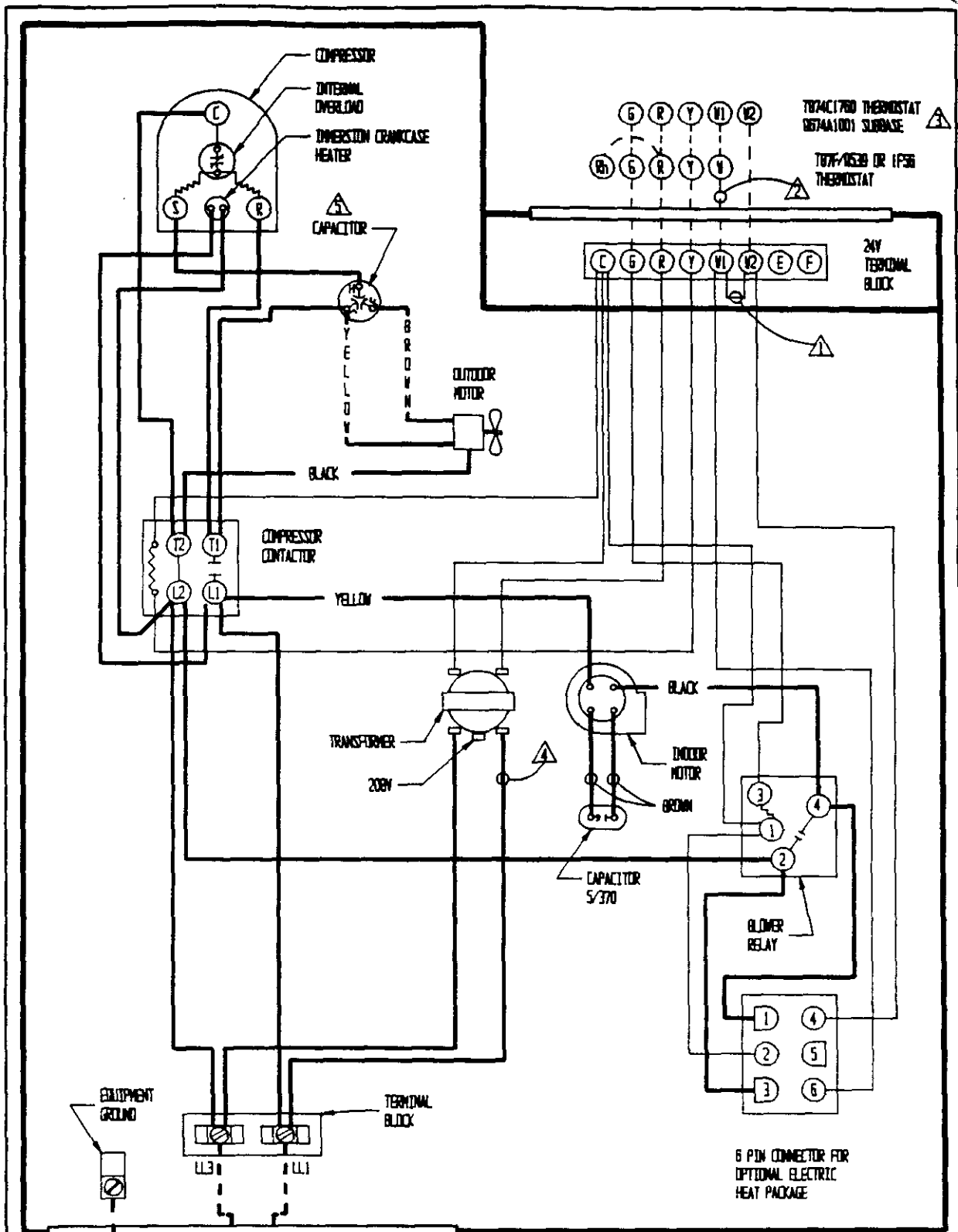

- ⚠ REMOVE JUMPER FOR TWO STAGE HEAT
- ⚠ NOT REQUIRED WHEN OPTIONAL HEAT PACKAGES ARE NOT INSTALLED
- ⚠ REQUIRED ONLY FOR USE WITH OPTIONAL ELECTRIC HEAT PACKAGES: EHPB-A15, EHPB-B12, EHPB-B15, WHEN TWO STAGE HEAT IS DESIRED.
- ⚠ FOR 208V OPERATION MOVE THIS WIRE TO 208V TRANSFORMER TAP.

MODEL NO.	CAPACITOR
P1030A1	35/5-370
P1036A1	40/5-370

	FACTORY WIRING	FIELD WIRING
LOW VOLTAGE	---	---
HIGH VOLTAGE	---	---

USE COPPER OR ALUMINUM WIRE

230/208V 60HZ 1-PH