

MANUAL 2100-060



## **FORCED AIR TOTAL COMFORT SYSTEM**

## **REFRIGERATION, HEATING AND AIR CONDITIONING**

**BARD MANUFACTURING CO. • BRYAN, OHIO 43506**

*Dependable quality equipment. . . since 1914*

## FORCED AIR TOTAL COMFORT SYSTEM

What is meant by the term "total comfort"? As applied to the home, total comfort means that the occupants of a home can eat, sleep, relax and work in a comfortable thermal environment. There are six components or properties which make up a true total comfort system: Even Temperature, Filtration (or Clean Air), Quietness, Outdoor Air (or Fresh Air), Humidity Control and Air Circulation. A broad line of modern well-engineered heating and cooling equipment and accessories have been developed to give homeowners the ultimate in total comfort at maximum efficiency and economy. An explanation of each comfort component follows.

### HUMAN COMFORT

"Comfort" has often been defined in terms of the equipment required to produce certain indoor conditions of temperature and relative humidity. Often a heating system is thought of as something which warms people occupying a building in cold weather. This idea is basically wrong.

The human body is a heat-producing machine which transfers the chemical energy in food to heat energy. Man is also a constant temperature animal and thus must eliminate various quantities of heat according to what kind of activity he is engaged in. The more vigorous the activity (running, jumping, etc.) the more heat must be eliminated, and the rate at which heat is removed will be greatly affected by the surrounding air temperature. When the body can eliminate heat at approximately the same rate as it is produced, man is at the comfort level.

Most people doing moderate work will be comfortable when the surrounding air temperature is between 70 to 74°F. with a relative humidity between 40 and 60%.

When the temperature is above this point, man perspires and is uncomfortable because the body cannot get rid of its heat fast enough. When the temperature is much below this point, he shudders and is cold because the body is getting rid of heat too fast.

The purpose of a heating or cooling system therefore is to maintain the surrounding air temperature and humidity at the level where the body can most effectively and efficiently regulate the disposal of excess heat.

### WHEN ARE YOU COMFORTABLE?

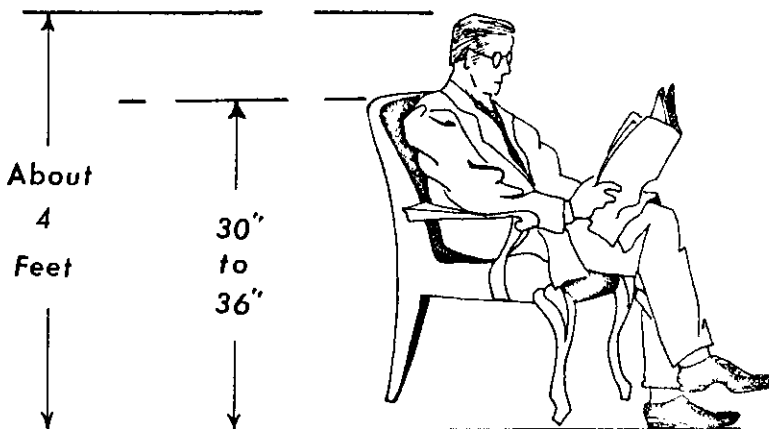

The space between the floor and approximately four feet upward is the most important from a comfort standpoint; this is the space normally occupied by seated occupants usually engaged in sedentary activities.

## HEAT TRANSFER

It must be understood that heat is a form of energy and therefore cannot be created or destroyed. However, it can be moved or transported from one place to another through many varied mediums.

In order to understand how a heating system works, it is necessary to understand the ways in which heat transfer can occur. Water always flows downhill, never uphill, always from a higher level to a lower level. In a similar way, one might think of heat as always flowing in one direction, from a position of higher temperature to one of lower temperature.

When water is flowing downhill, the steeper the hill the faster the water travels. Likewise in the transfer of heat, the greater the temperature difference the greater the quantity of heat will flow in a unit of time. There are three main ways the transfer of heat takes place. Conduction, radiation and convection.

### THE INGREDIENTS FOR TOTAL COMFORT

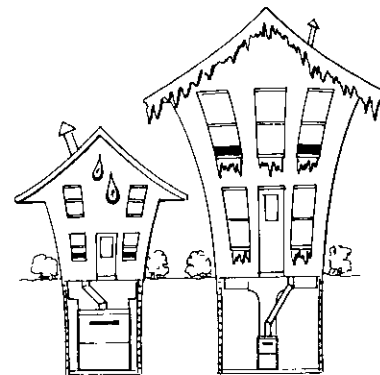

Oversized Heating Unit - Too Much Heat  
Undersized Heating Unit - Not Enough Heat

### EVEN TEMPERATURE

Constant, even temperature is probably the most important ingredient of a total comfort system. Even temperature of a conditioned space which makes an individual the most comfortable. The human body becomes aware of temperature changes that vary over one and a half degrees. Obviously, an individual could exist with temperature conditions that fluctuate quite a bit more, but he or she would not be comfortable. Constant even temperature does not necessarily mean that every room in the house must be the same temperature. Rooms such as bedrooms may vary from other rooms such as the kitchen. However, the even temperature of each room should remain constant throughout the heating or cooling season for the individual to be most comfortable.

Due to the growing concern over depletion of the world's energy resources, comfort has taken on a dual importance in the HVAC industry. Besides physical comfort, the individual now must consider the economics of achieving it. Recent governmental guidelines for energy conservation have recommended thermostats be set at 65° during the heating season and 78° during the cooling season. Oftentimes this means the indoor comfort condition will be a compromise between physical comfort and economic (also energy conserving) comfort.

**AIR CIRCULATION**

Air circulation, as its title implies, is the controlled and gentle movement of air to all parts of the house. Air circulation is used in the house during the heating and cooling season. Air circulation has a direct impact on the other ingredients of a total comfort system.

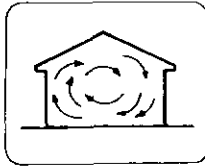

Proper air movement is important in maintaining even temperatures. Correct air velocity is dependent on accurate duct sizing location, and right blower speed (slower speeds for heating—higher speeds for cooling). Properly placed diffusers and return air grilles are also important for comfortable air movement. Supply diffusers are generally located so they will blanket areas of greatest heat transfer.

The amount of air distributed to each room of the house is determined by individual room requirements. The amount of supply air is maintained by the use of balancing dampers in all branch runs of the supply air system.

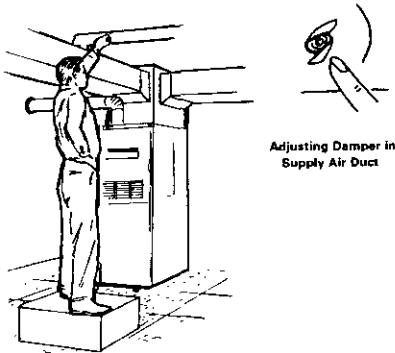

Adjusting Damper in Supply Air Duct

**FILTRATION**

In a total comfort system, a provision should be made to filter the air in the conditioned space. Lint, dust, dirt and other organic materials can then be removed from the air as they pass through the filtration device. This process will allow clean air to enhance indoor comfort conditions.

There are two basic types of air filters—mechanical and electronic. The filtering efficiency of the electronic filter is greater than that of the mechanical filter which means the electronic filter has a greater capacity to remove air-borne particles. The electronic air filter removes not only dust and smoke, but also many other minute air-borne particles such as pollen, some bacteria, and some viral organisms. These minute particles are very small and would pass through the mechanical filter.

The electronic air filter can help relieve allergies by removing pollen and other organisms from the air. The filter will also remove odors associated with organic materials. The electronic air filter cannot, however, remove vapor odors. The cost of an electronic air filter is greater than the cost of other filtering devices. However, the homeowner's cost can be diminished because the purchase of an electronic air filter is a deductible item on an individual's federal income tax should the filter be prescribed by a physician. This, in effect, lowers the initial cost.

Proper air filtering is also important to keep dust and dirt from collecting on the air mover and the cooling coil. If these parts of the total comfort system get too dirty, the efficiency of the system could be impaired. The mechanical filter is completely adequate to remove the dust and lint that could affect system efficiency.

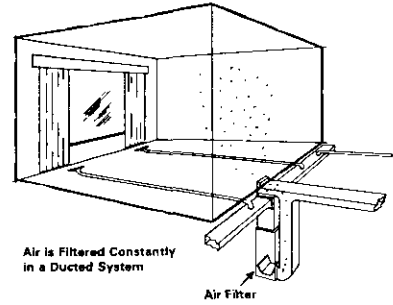

Air is Filtered Constantly in a Ducted System

Air Filter

**QUIETNESS**

The quietness of a total comfort system is extremely important. It has been psychologically proven that a certain degree of anxiety, associated with erratic and drastically changing noise levels, can develop within an individual. A noisy total comfort system can be an emotional headache, especially when entertaining guests or during a casual home conversation. Keep in mind that a properly operating total comfort system is one which is rarely seen or heard by the homeowner. Noises from the heating and cooling system can be broken down into two types—air noises and mechanical noises.

**AIR NOISES**

Air noise is directly related to air velocity. As air moves faster, more noise can be produced from components; as air moves slower, less noise is produced. Air velocity is controlled through a carefully designed air distribution system within the heating and cooling system.

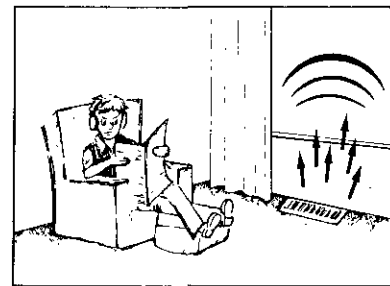

Air Noise

Oftentimes air velocity can create noise through the supply diffusers. To hold diffuser noise to a minimum it is recommended that air balancing be done by balance dampers placed within the branch runs of the duct. If balancing is done by air dampers in the diffuser, there is more chance of creating air velocity noise.

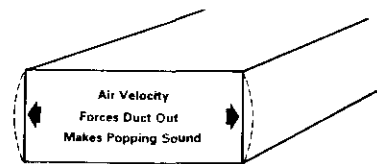

Air Velocity Forces Duct Out Makes Popping Sound

**MECHANICAL NOISES**

Mechanical noises within the heating and cooling system may arise from system components made of metal. Metal components include mechanical components, control components and the duct.

A recommended way to minimize noise is through the selection of high quality heating and cooling components. Equipment today is being designed and manufactured with quiet system operation in mind.

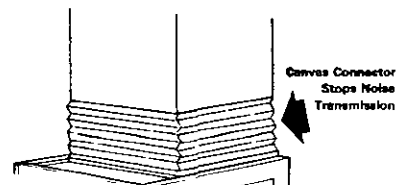

Canvas Connector Stops Noise Transmission

**OUTDOOR AIR**

With homes as tight and well constructed as they are today, it is absolutely essential that some provision be made for introducing fresh outdoor air into the home to prevent staleness and stuffiness from developing. In a total comfort system, provision is made to introduce controlled amounts of outdoor fresh air into the home. This air is tempered by air already in the home to provide a fresh indoor living environment.

The introduction of a controlled quantity of fresh outdoor air into the home is a very important part of a total comfort system. This constant supply of fresh air makes it possible to create a slight positive pressure inside the house, counteracting the normal escape of air. The fresh outdoor air will also eliminate stuffiness and staleness during both the heating and cooling season.

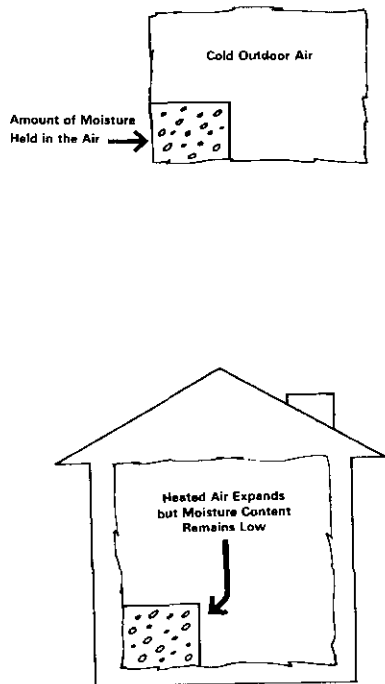
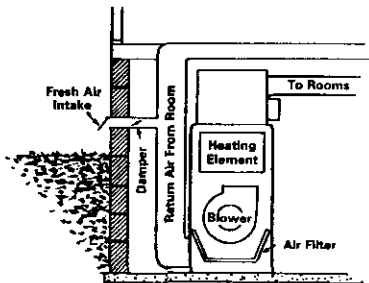

**HUMIDITY CONTROL**

In order to produce total comfort, the moisture content of the air must be controlled during the heating and cooling seasons. During the winter months, the cold outdoor air introduced into the system tends to lower the moisture content of the air in the house. The moisture content of the air must be increased to compensate for this. The opposite happens in the summer. The interior of the house is filled with muggy, moisture-laden air that saps strength and puts tempers on edge. The moisture content of the air must be decreased to achieve comfort during this period.

**HUMIDITY CONTROL IN WINTER**

During the winter months, homeowners often complain of static electricity, certain amounts of skin irritation and a scratchy throat and nose caused by the membranes of the throat and nose drying up. The homeowners may also complain of furniture and plaster drying and cracking. These are symptoms of low relative humidity within the home.

**HUMIDITY CONTROL IN SUMMER**

During the summer months, properly sized cooling equipment is the key to the control of humidity. This will help in removing excess humidity in a controlled fashion and eliminating the sticky feeling. If the cooling equipment is oversized, the temperature of the house will be cooled very quickly, but the relative humidity will still be high. If the equipment is undersized, the relative humidity will be lowered, but the temperature will remain high.

**COMFORT CHART DATA**

Dry Bulb Temp.		Percent Relative Humidity				
		80	70	60	50	30
65	Wet Bulb	61				
	Eff. Temp.	64				
66	Wet Bulb	62	60	57.5		
	Eff. Temp.	65	64	63.5		
67	Wet Bulb	63	61	58.5	56	
	Eff. Temp.	66	65	64.5	64	
68	Wet Bulb	64	61.5	59.5	57	54.5
	Eff. Temp.	67	66	65.5	65	64
69	Wet Bulb	65	62.5	60	58	55
	Eff. Temp.	67.5	67	66	65.5	65
70	Wet Bulb	66	63.5	61	58.5	56
	Eff. Temp.	68.5	67.5	66.5	66	65.5
71	Wet Bulb	66.5	64.5	62	59.5	56.5
	Eff. Temp.	69	68	67.5	67	66
72	Wet Bulb	67.5	65	63	60	57.5
	Eff. Temp.	70	69	68	67.5	66.5
73	Wet Bulb	68.5	66	63.5	61	58
	Eff. Temp.	71	70	69	68	67.5
74	Wet Bulb	69.5	67	64.5	62	59
	Eff. Temp.	72	71	70	69.5	68.5
75	Wet Bulb	70.5	68	65.5	62.5	60
	Eff. Temp.	73	72	71	70	69
76	Wet Bulb	71.5	69	65	63.5	60.5
	Eff. Temp.	73.5	72.5	71.5	70.5	70
77	Wet Bulb	72	70	67	64.5	61
	Eff. Temp.	74.5	73.5	72.5	71.5	70.5
78	Wet Bulb	73	70.5	68	65	62
	Eff. Temp.	76	75	74	73	71.5
79	Wet Bulb	74	71.5	69	66	63
	Eff. Temp.	77	75.5	74.5	73.5	72
80	Wet Bulb	75	72.5	69.5	66.5	63.5
	Eff. Temp.	77.5	76	75	74	73
81	Wet Bulb	76	73.5	70.5	67.5	64
	Eff. Temp.	78	77	76	75	73.5
82	Wet Bulb	77	74.5	71.5	68.5	65
	Eff. Temp.	79	78	77	75.5	74

Shaded area shows Comfort Zone at which 70% of test subjects were comfortable.

Fig. 7-C

Cooling Systems are usually designed to provide 80 degree dry bulb and 67 degree wet bulb which will provide 50% Relative Humidity and 74 degree effective temperature.

On 80° D.B. line cross over on wet bulb line to 66.5 degrees and note 74 degrees effective temperature, then move to top of sheet and read 50% Relative Humidity.

Data from A.S.H.R.A.E. Guide

## SUMMARY

The six ingredients of total comfort have been discussed:

1. Even temperature
2. Filtration
3. Quietness
4. Outdoor air
5. Humidity control
6. Air circulation

Each ingredient plays its own distinctive part in creating a true total comfort system.

There are several types of heating and air conditioning systems available which are capable of producing total comfort. A single furnace with an air conditioning coil on it, located in the central part of the house, can produce all the ingredients of total comfort. However, in some homes being built today it is more feasible and economical to put in other types of total comfort systems.

For example, a long ranch house with the daily living quarters at one end and sleeping quarters at the other end, could be zoned by installing two complete systems. Each system would include a furnace and an air conditioning unit. One system would handle the bedroom area; the other system would handle the daily living area. This type of installation is called a zoned system. It permits the homeowner to control the temperatures in the various parts of his house with several thermostats. During the day, the bedroom area could be kept considerably warmer in the summer (or cooler in the winter) than the living area. This cuts down the amount of air

conditioning or heating needed for the house, greatly reducing the energy consumed. A two-story house might be handled in the same way. One system would handle the downstairs, another system could handle the upstairs. The homeowner reaps the benefit of lower utility bills.

Since many of the homes built today are vastly different in design and concept, it is important to have a choice of a multitude of systems to handle individual house design. If the right system is applied to a home, the ultimate in comfort and important energy conservation will be achieved.

## BASIC SYSTEMS, COMPONENTS AND MAINTENANCE

This section introduces the trainee to ducted forced air systems. These systems are described and typical applications and configurations detailed.

The remainder of the manual concentrates on the ducted residential HVAC systems. Components common to these systems are discussed. The components are the duct, equipment cabinet, temperature treatment section, blower, filter and thermostat.

The concept of scheduled maintenance is reviewed. Step-by-step maintenance procedures for the common thermostat, blower and filter are then outlined. Procedures for servicing the remainder of the components that make up the various types of gas, oil and electric heating systems and cooling systems are outlined individually in later sections of this manual.

## DUCTED SYSTEMS

The ducted, forced-air system is perfectly suited to supplying the six basic ingredients of total comfort. This type system uses a centralized approach in creating a total comfort environment in the home as discussed in the Total Comfort section of this book.

In the ducted system, air is treated for temperature (both heating and cooling), humidity and cleanliness in one central location. Provisions for outdoor fresh air and quiet operation are incorporated into the system. The treated air is then moved by a blower and forced through a network of duct to strategic points all over the home.

Since the ducted, forced air system is able to deliver all the elements of total comfort, its advantages over the non-ducted system are obvious. Additional advantages are: the system's ability to distribute passive solar heat gains from sunny rooms to points throughout the home by picking it up in the return air side and redistributing it through the supply duct network; the relative ease of incorporating whole-house cooling, convenience of incorporating humidifying and air cleaning capabilities into an existing heating system; and the space savings of registers versus radiators and convectors in the living areas.

Illustration of accumulated pressure drop through ducts & accessories.

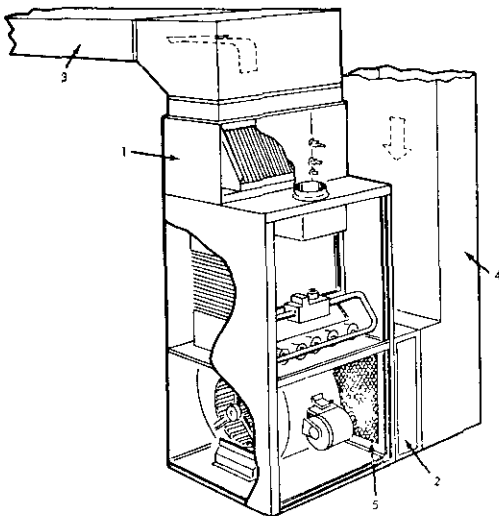

1. Coil in Plenum
2. Electronic Air Cleaner (if used)
3. Supply Duct
4. Return Duct
5. Filter
6. Blower

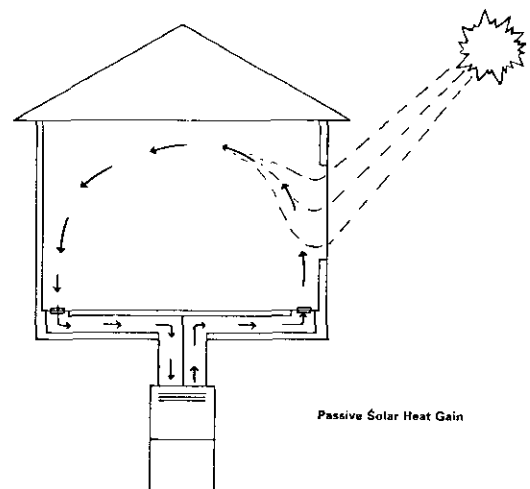

Passive Solar Heat Gain

**CONFIGURATION**

Ducted, forced air systems take on various configurations, depending mainly upon which best fits the construction design of the house. Other factors which may determine system configuration are installation costs, service access and climate.

Heating applications can be either upflow, downflow, or horizontal flow, flow meaning the direction the blower forces the air from the unit. Air flow direction is dependent on heating unit placement as well as the most desirable location to place the duct. Generally, a central location in the structure is selected for unit placement. This installation procedure minimizes long spans of duct. For example, if the home has a basement, an upflow heating unit is normally located there; the duct is installed above the furnace near the floor joists. In homes without basements, the heating units may be installed in a utility room/closet, crawl space or attic space with the duct installed in the attic or crawl space.

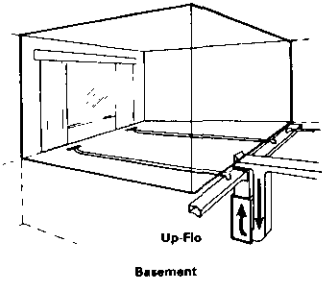

If the home is built on a concrete slab, the heating unit is normally in a utility closet or in the attic. A utility closet application in colder climates is usually downflow; the duct is embedded in the concrete and helps warm the floors during the heating season. The utility closet application in warmer climates is often upflow, with the duct above the ceiling. This type application is better suited to cooling (cool air falls, promoting air circulation) and usually has less materials and labor cost in the installation. Attic applications normally employ horizontal-flow units, with the duct also in the attic.

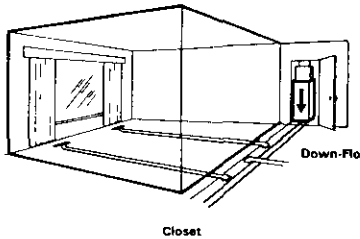

If the house is built over a crawl space, the heating unit is usually located in the crawl space (horizontal flow unit) or a utility closet (downflow unit). In both applications, the duct is placed in the crawl space.

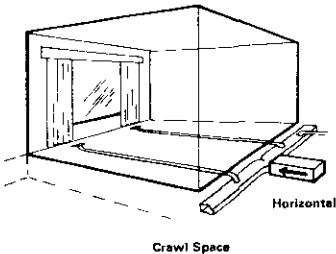

You can see from these diagrams how the evaporator cooling coil, humidifier and electronic air cleaner are incorporated into the various systems configurations. It is important to remember there is also an outdoor unit that houses a condensing coil, a compressor and other components essential to produce cooling. Refrigerant lines link the outdoor unit with indoor evaporator coil. This type of indoor/outdoor arrangement is called a split system.

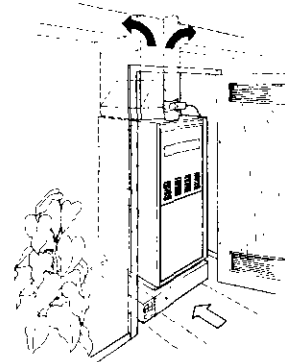

Closet Installation with Cooling Coil and Electronic Air Cleaner

There are packaged cooling systems and packaged combination heating/cooling systems. In both systems, all components are housed in a single outdoor unit, either on a slab at grade level or on a rooftop. Both types of packaged units are self-contained systems, with their own blower and duct. Air flow is normally horizontal for a slab unit and downward for a rooftop unit.

Another type of combination heating/cooling unit is a heat pump. Fast becoming popular for energy efficiency reasons, the heat pump is basically a cooling system with the capacity to reverse its system operation to produce heating. Much like split system cooling, the heat pump can be incorporated into the home heating system, where it becomes a split system application. The primary heat source is the heat pump as it transfers heat from outdoors to indoors; the furnace is the auxiliary heat source. Heat pumps are also made in packaged outdoor units, independent of the existing heating systems. (Heat pumps are discussed in detail in the Bard Heat Pump Manual).

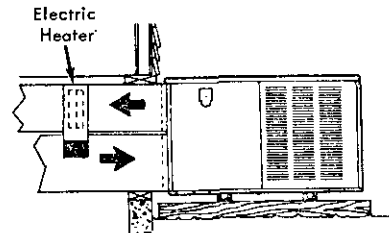

Typical self-contained air conditioner or heat pump installed in a through-the-wall manner.

Typical furnace used with cooling coil. Furnace may be either gas, oil or electric. Up-flow type is shown; however, down-flow or horizontal-flow split systems would be similar.

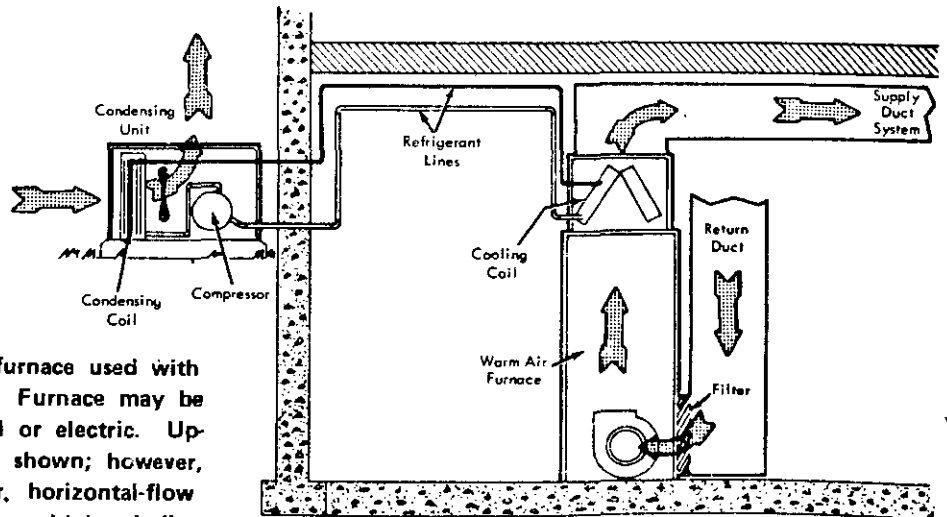

## BASIC COMPONENTS

There are basic components that are common to all residential forced air heating and cooling systems: These are duct, equipment cabinet, temperature treatment section, blower, filter and thermostat.

### DUCT

Duct is the network of "tubes" which carries the treated supply air to the conditioned space, and the return air back to a blower for recirculation. Air movement in the duct works on the principle of air pressure difference; air moves from the higher pressure area to the lower pressure area.

Since air pressures in the duct are relatively low, duct can be made from various materials. Galvanized sheet steel is probably most common, with aluminum, plastic, fiberboard and fiberglass also used. Duct is either round or rectangular in shape and rigid or flexible in configuration. Insulating material is often applied to the duct (either inside or outside) to reduce heat transfer and add sound control. This is especially important on duct running through an unconditioned area such as an attic or possibly a crawl space.

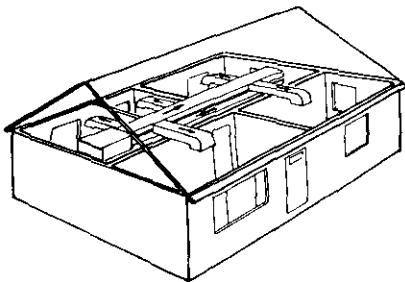

Overhead Attic Supply Ductwork  
with Ceiling Diffusers

Local building codes often dictate the type duct material that can be used. For example, supply ducts should be made of noncombustible material. Also, if the ducts are lined on the inside with insulating or noise reducing fiberglass, these materials must be surface coated to prevent harmful particles from eroding into the system.

There are many different fittings or parts which make up a rigid sheet metal duct system. These parts all must fit together so the duct can make all the bends and turns to be compatible with the construction of the house and distribute treated air to all living areas. The joints where the fittings attach should be airtight. Duct tape or sealant provides a quick and economical fix on leaky joints. Also, fabric joints or duct connectors are often used to absorb noise and allow for the expansion and contraction of the duct as it is heated and cooled.

Flexible duct made of spring steel wire and plastic or fiberglass alleviates the need for most of the fittings and reduces installation time. However, flexible duct is not as durable as metal duct.

The supply plenum is the sheet metal chamber at the supply outlet of the furnace that feeds the supply ducts. The return air plenum is the sheet metal chamber at the return air entry to the furnace into which the return ducts are fed.

Three basic supply duct configurations that are commonly used are the extended plenum, perimeter loop and perimeter radial. The extended plenum configuration is well suited to basement or crawl space applications. The perimeter loop is popular for cold climate slab applications. The perimeter radial is used in crawl space, attic and warm climate slab applications and offers economy of materials and labor.

Supply air from the duct is released into the conditioned space through outlets called registers or diffusers. Registers deliver air in concentrated streams; diffusers in wider, fan-shaped patterns. These outlets may be located in the floor, wall (high or low sidewall) or ceiling. To promote proper air circulation and to prevent unwanted drafts, outlets are positioned along

outside walls and windows of the house. Registers and diffusers usually have an adjustable damper to balance system air flow. Once a system is balanced the damper settings should not be changed. However, proper air balancing should be achieved by the use of balancing dampers in each branch run.

The return air duct inlet covers in the conditioned space are called grilles. Grilles are usually nonadjustable.

Regardless of the type or configuration, all duct and outlets must be sized to carry proper air volumes. This is determined by heating and cooling requirement calculations for the house (see ACCA Application Manual).

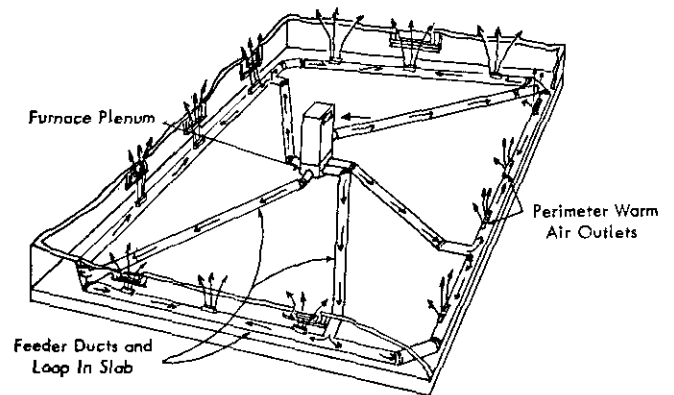

Figure 1. The perimeter loop system is particularly effective in colder climates. It has excellent utility in houses built on slabs in that good heat distribution is insured and floors are kept warm also.

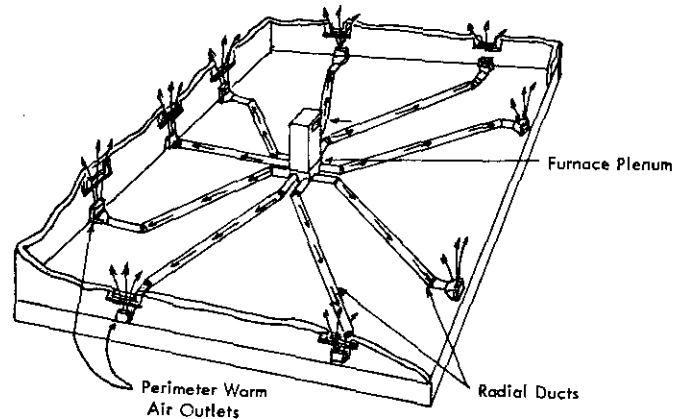

Figure 2. Less expensive than a perimeter loop system, the radial duct system provides for warm floors and is applicable both in crawl space construction and concrete slabs.

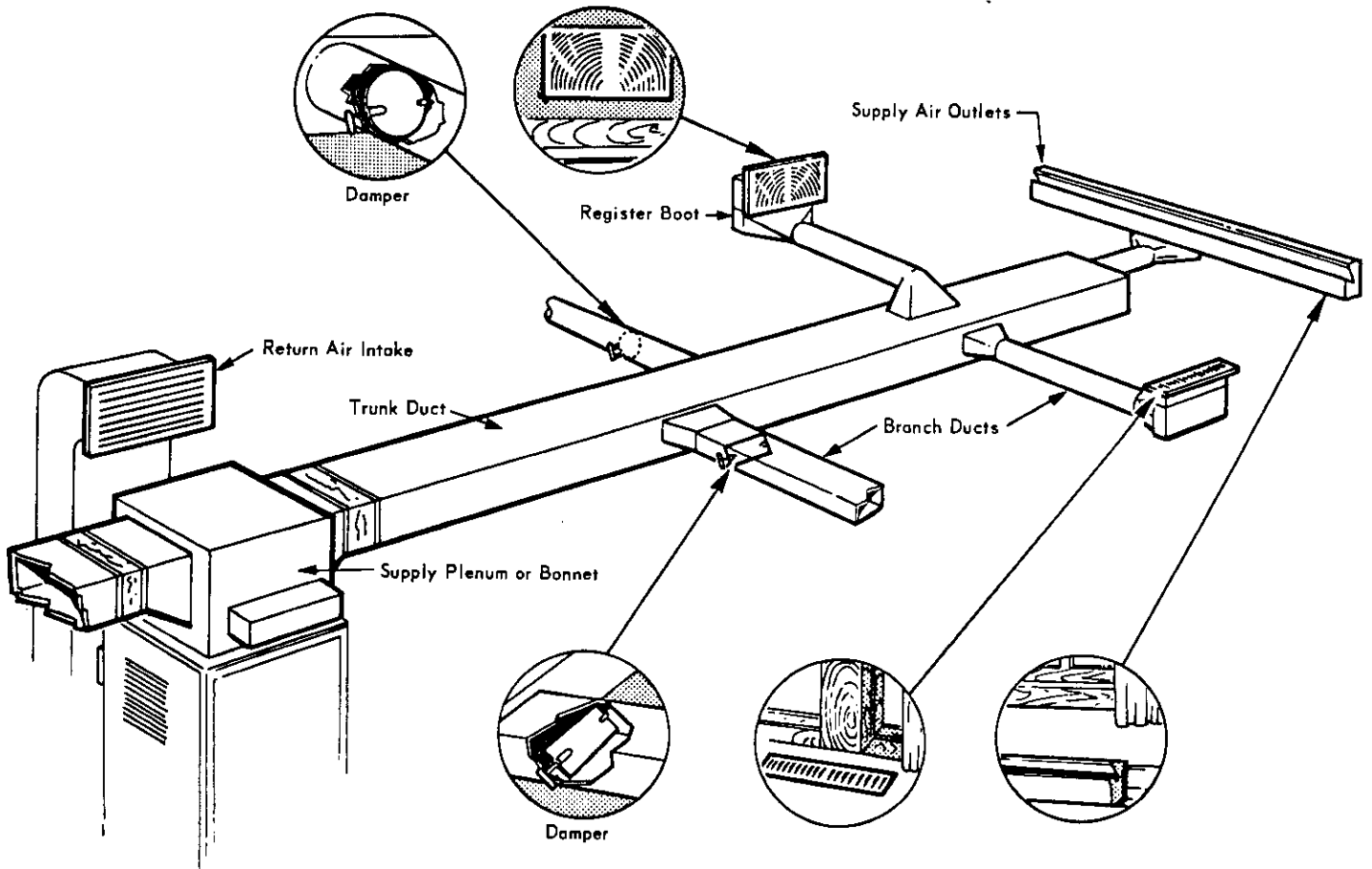

Figure 3. Essential elements for a ducted air distribution system. Extended Plenum System installed in basement.