

INSTALLATION INSTRUCTIONS



HIGH EFFICIENCY WATER SOURCE

Split Heat Pump Systems

MODELS
WQS30
WQS36
*WQSD30
*WQSD36

* Built-in hot water
heat exchanger.

GROUND WATER TEMPERATURES 45-75°F

BARO MANUFACTURING COMPANY
P. O. Box 607 Bryan, Ohio 43506
(419) 636-1194

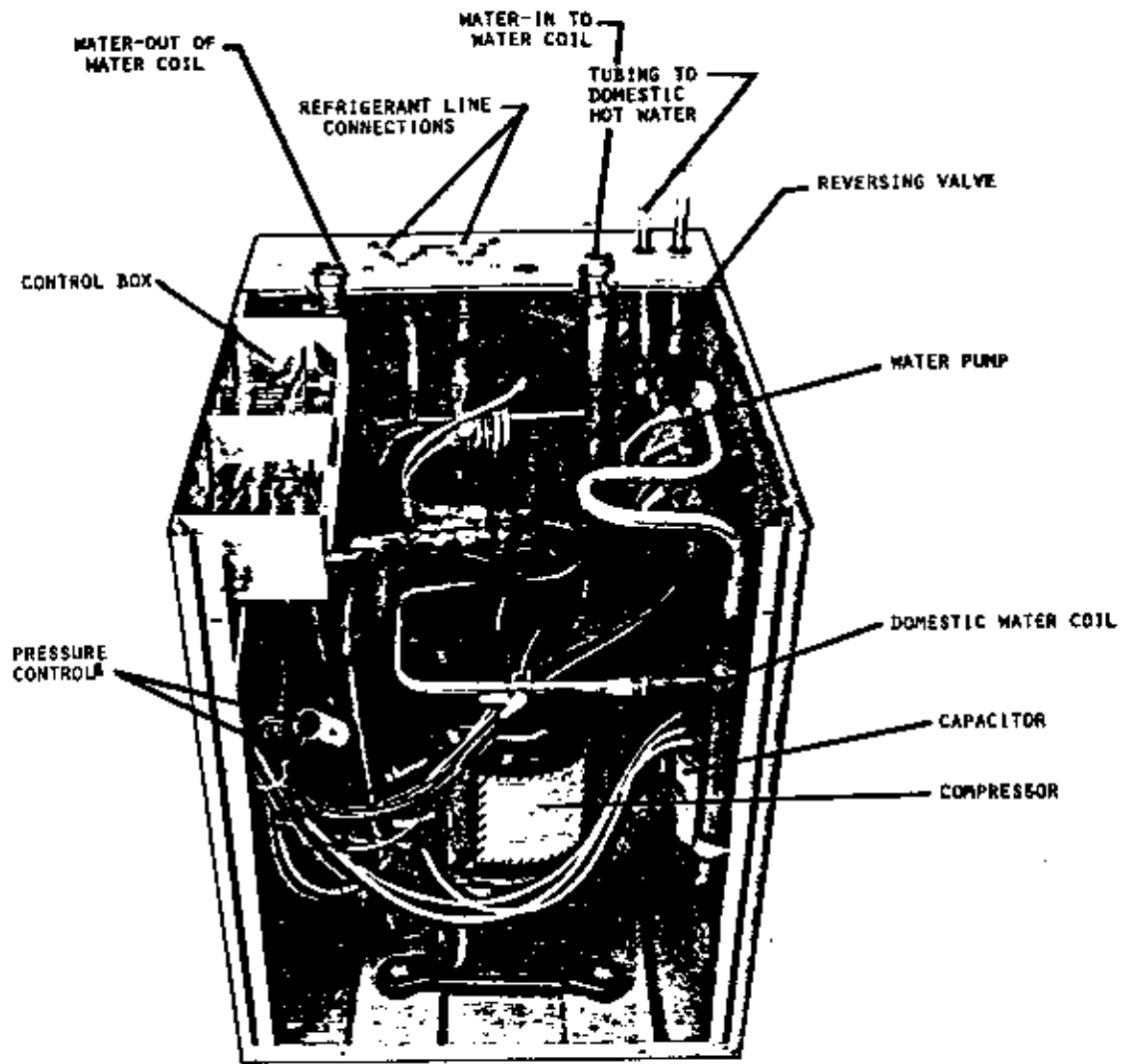

WDS - COMPRESSOR SECTION

1.0 GENERAL

Units are ship wired, require wiring, 230-2C The equipment is trained, electricians. Any refrigerant charging only

ately assembled and internally thermostat

These instructions any separate heat pump system winning the and/or label

While these commended national specification made.

*Ship 3.3 & 3.4
jump to 3.5.1
as shown →*

2.0 UNPACK

Upon receipt checked for damage is last carrying

3.0 INSTALLATION

3.1 BTUH CAPACITY SELECTION

Capacity of the unit for a proposed installation should be based on heat loss calculations made in accordance with methods of the Air Conditioning Contractors of America, formerly National Warm Air Heating and Air Conditioning Association. The air duct system should be sized and installed in accordance with Standards of the National Fire Protection Association For The Installation of Air Conditioning and Ventilating Systems of Other Than Residence Type, NFPA No. 90A, and Residence Type Warm Air Heating and Air Conditioning Systems, NFPA No. 90B.

3.2 SITE SELECTION

The unit may be installed in a basement, closet or utility room provided adequate service access is insured. Ideally, three sides of the unit should have a minimum access clearance of two feet but the unit can be adequately serviced if two or only one side has the minimum two feet clearance. The unit should be located in the conditioned space to prevent freezing of the water lines and to permit proper, automatic shut off of the water regulating valves. See water piping section.

Clearance to combustible materials is 0 inches for the heat pump. If an optional duct heater is installed, follow the instructions packed with the duct heater for specifications regarding clearance to combustible materials for the installation. See instructions for the installation for the clearance.

Before setting the unit, consider ease of piping, drain and electrical connections for the unit. Also, for units with heat recovery unit, consider the proximity of the unit to the water heater or storage tank. Place the unit on a solid base, preferably concrete to minimize undesirable noise and vibration. DO NOT elevate the base pan on rubber or cork vibration eliminator pads as this will permit the unit base to act like a drum, transmitting objectionable noise.

DUCTWORK

If the unit is to be installed in a closet or utility room which does not have a floor drain, a secondary drain pan under the entire unit is highly recommended.

Do not install the unit in such a way that a direct path exists between any return grille and the unit. Rather, insure that the air entering the return grille will make at least one turn before entering the unit air coil. This will reduce possible objectionable compressor and air noise from entering the occupied space.

Design the ductwork according to methods given by the National Warm Air Heating and Air Conditioning Association. When duct runs through unconditioned spaces, it should be insulated with a minimum of two inches of fiberglass insulation with vapor barrier. It is recommended that flexible connections be used to connect the ductwork to the unit in order to keep the noise transmission to a minimum.

FILTER

This unit must not be operated without a filter. Insufficient air flow due to undersized duct systems or dirty filters can result in nuisance tripping of the high or low pressure controls. Refer to the installation instructions of blower coil or heater "A" coil for correct air flow and static pressure requirements or see specification sheets.

All electrical connections are made through the top of the unit. High voltage connections are made with the contactor in the control box. Low voltage connections are made to the terminal strip mounted in the control panel box. Refer to the wiring diagram for connecting the terminals.

3.5.1 MAIN POWER

Refer to the unit serial plate for wire sizing information and correct overcurrent protection size. Each unit is marked with a "Minimum Circuit Ampacity." This means that field wiring conductors must be sized to carry that amount of current. Each unit and/or wiring diagram is also marked "Use Copper Conductors Only," meaning the leads provided are not suitable for aluminum wiring. Refer to the National Electric Code for complete current-carrying capacity data on the various grades of wiring material.

The unit rating plate lists "Maximum Overcurrent Protective Device" that is to be used with the equipment. This device may be a time delay fuses or HACR Type circuit breaker. The correct size overcurrent protective device must be used to provide for proper circuit protection and to avoid nuisance trips due to the momentary high starting current of the compressor motor.

3.5.2 CONTROL CIRCUIT - LOW VOLTAGE WIRING

A 24 volt terminal strip is mounted in control box of the unit. Two types of thermostats are available: 1) Single stage heat, single stage cool to operate the heat pump alone—without backup electric or fossil heaters. This thermostat is equipped with a signal light to indicate when the unit is "locked out" because of the low or high pressure control. Refer to the wiring diagrams at the end of this manual for correct connection of the terminals. 2) Two stage heat, single stage cool to operate the heat pump or electric heaters or fossil fuel furnace on heating or the heat pump on cooling. This thermostat is also equipped with a signal light to indicate when the unit is "locked out" because of operation of the low or high pressure control. In addition, a second signal light tells when the unit has been placed in Emergency Heat. Refer to the wiring diagram at the end of this manual and to the wiring diagram packed with the duct heater for correct connection of the low voltage terminals.

3.6 CONDENSATE DRAIN

Determine where the drain line will run. This drain line contains cold water and must be insulated to avoid droplets of water from condensing on the pipe and dripping on finished floors or the ceiling under the unit. A trap MUST BE installed in the drain line and the trap filled with water prior to start up. The use of plugged tees in place of elbows to facilitate cleaning is highly recommended.

Drain lines must be installed according to local plumbing codes. It is not recommended that any condensate drain line be connected to a sewer main. The drain line enters the unit through the water access panel and connects to the FPT coupling under the condensate drain pan.

3.7 PIPING ACCESS TO THE UNIT

Water piping to and from the unit enters the top of the unit casing through the water access panel. Piping connections are made directly to the heat exchanger coil and are 3/4 inch PPT.

3.8 WATER CONNECTIONS

It is very important that an adequate supply of clean, non-corrosive water at the proper pressure be provided before the installation is made. Insufficient water, in the heating mode for example, particularly at low water temperatures, will cause the low pressure control to trip, shutting down the heat pump. In assessing the capacity of the water system, it is advisable that the complete water system be evaluated to prevent possible lack of water or water pressure at various household fixtures whenever the heat pump turns on. All plumbing to and from the unit is to be installed in accordance with local plumbing codes. The use of plastic pipe, where permissible, is recommended to prevent electrolytic corrosion of the water pipe. Because of the relatively cold temperatures encountered with well water, it is strongly recommended that the water lines connecting the unit be insulated to prevent water droplets from condensing on the pipe surface.

Refer to piping Figure 4. Test points (6) and (7), to measure water temperature and water pressure entering and leaving the unit, must be included in the piping installation. Either the self-sealing threaded test plugs (available from Hard) or more conventional gauge tees and thermometer wells can be used. These test points will aid in the initial start-up of the equipment as well as in the future service work. Water regulating valves 1 and 2, are required on all ground water heat pump installations and on all installations having a hot water desuperheater. These valves insure that the proper water flow is maintained to the heat pump in response to variations in the refrigerant pressure. One valve, V46AC, opens in response to an increase in discharge pressure during the cooling cycle. The other valve, V46NC, opens in response to a decrease in suction pressure during the heating cycle.

One valve only opens during cooling, the other valve only opens during heating. The valves should be installed on the LEAVING SIDE of the unit as shown. The reason for this location is to maintain pressure on the water system (including the unit water coil) when the unit shuts down. Constant water pressure will help prevent solids, dissolved in the water, from precipitating and causing scaling.

Steps to connect water regulating valve capillaries to unit:

1. The capillaries from the two valves are connected to a field supplied 1/4 inch SAE tee and length of 1/4 inch tubing.
2. Route the tubing through the pipe access panel, (5) through the 7/8 inch hole in the center of the panel.
3. Connect the other end of the 1/4 inch tubing to the branch (no valve core) of the 1/4 inch flare tee with depressor. Avoid having the tubing touch other piping or components inside the unit as constant vibration will weaken the tubing and could cause leaks.
4. THIS STEP MUST BE DONE LAST TO AVOID LOSS OF REFRIGERANT CHARGE. Connect the tee's female end (with valve depressor) to the refrigerant port located in the tubing which joins the reversing valve to the water coil.

The figure shows the use of shut-off valves (9) and (11), on the in and out water lines to permit isolation of the unit from the plumbing system should future service work require this. Globe valves should not be used as shut-off valves because of the excessive pressure drop inherent in the valve design. Instead use gate or ball valves as shut-offs so as to minimize pressure drop.

Drain cocks (8) and (10), and tees have been included to permit acid cleaning the refrigerant-to-water coil should such cleaning be required. See WATER CORROSION.

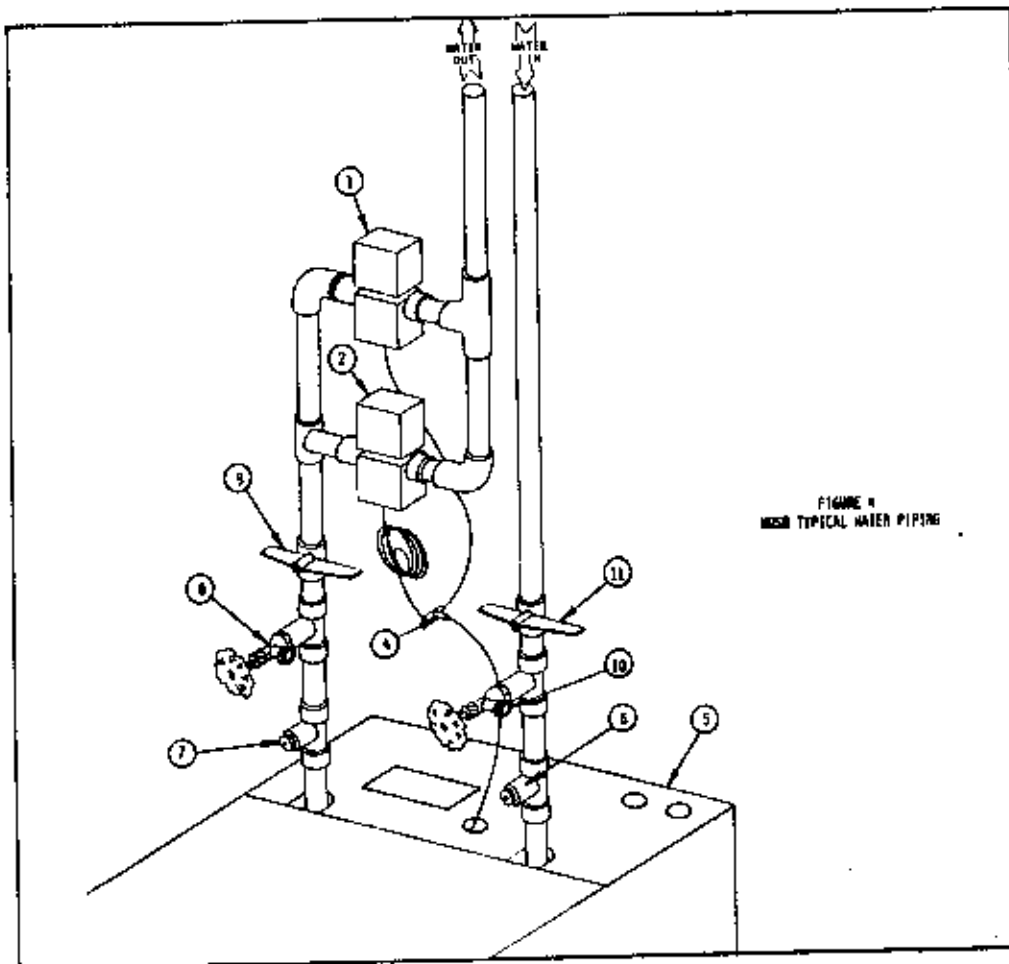

3.9 WELL PUMP SIZING

Strictly speaking, sizing the well pump is the responsibility of the well drilling contractor. It is important, however, that the HVAC contractor be familiar with the factors that determine what size pump will be required. Rule of thumb estimates will invariably lead to under or oversized well pumps. Undersizing the pump will result in inadequate water to the whole plumbing system but with especially bad results to the heat pump—NO HEAT/NO COOL calls will result. Oversized pumps will short cycle and could cause premature pump motor or switch failure.

The well pump must be capable of supplying enough water and at an adequate pressure to meet competing demands of water fixtures. The well pump must be sized in such a way that three requirements are met:

1. Adequate flow rate in gpm.
2. Adequate pressure at the fixtures.
3. Able to meet the above from the depth of the well-feet of lift.

The pressure requirements put on the pump are directly affected by the diameter of the pipe being used as well as by the water flow rate through the pipe. The worksheet included in Manual 2100-054 should guarantee that the well pump has enough capacity. It should also insure that the piping is not undersized which would create too much pressure due to friction loss. High pressure losses due to undersized pipe will reduce efficiency and require larger pumps and could also create water noise problems.

FINAL CHECK LIST

Before starting unit after installation or servicing, check the following:

1. Proper voltage to unit.
2. Correct fuse sizes.
3. Tight electrical connections.
4. Water system clean and flushed.
5. Air purged from water system.
6. Adequate water flow and pressure to the unit.
7. Water temperature between 45°F and 95°F.
8. Condensate line clear and unclogged.
9. Blower wheel free to rotate.
10. Return air filter is installed.
11. Access panels and enclosures are installed and secured.

To start and check balance the unit, see the "Sequence of Operation" and "System Start-Up Procedures" in the Installation Instructions.

4.0 SEQUENCE OF OPERATION -- WQS WITH FOSSIL FUEL FURNACE

4.1 FIRST STAGE HEATING

On a call for heating a circuit is made between R and Y at the room thermostat. At the same time a circuit is made between R and G. The "G" circuit energizes the blower relay of the fan center. The blower relay contacts complete a circuit to the furnace blower motor and the blower runs. The Y circuit is routed to the Y terminal of the compressor section and then to terminal 4 of the lockout relay. Terminal 4 of the lockout relay provides three possible paths for the current to take.

1. Terminal 4 to 2 — only possible if the lockout relay is energized.
2. Terminal 4 to 3 — in combination with the compressor contactor coil and offers high resistance to current flow.
3. Terminal 4 to 5 — path of least resistance. Current flows until lockout relay is energized.

From terminal 5 of the lockout relay the Y circuit continues through the low and high pressure switches (normally closed) to the normally closed contacts (5 and 6) of the Fossil Fuel Relay and then to the compressor contactor coil. The compressor contactor coil is energized and a high voltage circuit is made to the compressor—the compressor runs. Since the "O" terminal is not energized, the reversing valve solenoid is not energized and the unit is in heating.

4.2 SECOND STAGE HEATING

NOTE: FOR OIL FURNACES USE AN ISOLATION RELAY TO KEEP THE TWO TRANSFORMER CIRCUITS SEPARATED. CORRECT THE ISOLATION RELAY COIL BETWEEN "Y" AND "O". CORRECT THE OIL PRIMARY THERMOSTAT TERMINALS TO THE SWITCH CONTACTS OF THE ISOLATION RELAY.

SECOND STAGE STARTS GAS VALVE

When the second stage bulb of the wall thermostat makes, a circuit is completed between R and W2 of the wall thermostat. This circuit is routed to W2 of the compressor section and then to terminal 3 of the Fossil Fuel Relay—the relay is energized. Normally closed contacts (5 and 6 of the Fossil Fuel Relay) in the compressor contactor coil circuit open and the compressor contactor coil drops out. The compressor no longer is running. Normally open contacts (2 and 4 of the Fossil Fuel Relay) close and the W2 circuit continues from terminal 3 of the Fossil Fuel Relay to terminal 4 across the now closed contacts to terminal 2 and then to terminal V of the compressor section. Terminal V is connected to the gas valve solenoid which is now energized and the gas valve opens. Fossil fuel furnace is now energized.

FIRST STAGE KEEPS GAS VALVE CLOSED

When the compressor contactor coil circuit is interrupted by the functioning of the Fossil Fuel Relay (5 and 6 open), the path of least resistance for the Y circuit is no longer to the compressor contactor coil (4 to 5 of the lockout relay). Current can now flow through the lockout relay coil (4 to 3) returning through the compressor contactor coil as a wire and proceeding to the common side of the transformer. The lockout relay is energized. The resistance of the lockout relay coil causes a voltage drop sufficient to prevent the compressor contactor coil from energizing (no longer 24 volts at the compressor contactor coil) and the compressor is prevented from running.

When the lockout relay coil is energized, the Y circuit (first stage heating) is re-routed from 4 and 5 of the lockout relay (now open) to 4 and 2 of the lockout relay (now closed). From terminal 2 of the lockout relay the first stage heating Y circuit goes to the normally closed contacts (5 and 6) of the changeover relay. From the changeover relay the circuit goes to terminal V of the compressor section and then to the gas valve. The gas valve, therefore, though originally energized by second stage heating, will not shut off until first stage heating is satisfied.

The purpose of the changeover relay is to prevent operation of the gas valve when the lockout relay is energized in cooling (for example high pressure switch opens). The coil of the changeover relay is connected to the "O" terminal (only energized in cooling) and therefore the changeover relay contacts (5 and 6 - normally closed) are open in cooling—gas valve is prevented from operating.

4.3 COOLING

When the system switch of the wall thermostat is moved to COOL a circuit is completed from R to O (whether the cooling bulb is made or not). The "O" terminal is connected to the reversing valve solenoid and the changeover relay coil. The reversing valve solenoid and changeover relay coil are energized and stay energized until the system switch of the wall thermostat is moved from the cool position (to OFF, HEAT or EM.HEAT).

When the cooling bulb makes, the Y circuit is energized and follows the path described above for first stage heating. The compressor runs and, since the reversing valve is energized, the unit is in cooling.

4.4 CHECK LIGHT

If the Y circuit to the contactor coil is interrupted because the high (low) pressure switch opens, the Y circuit takes the path of least resistance at the lockout relay and goes from 4 to 3 of the lockout relay and the lockout relay coil is energized. The lockout relay coil will remain energized until the Y circuit is broken either by moving the system switch to OFF or by satisfying the first stage heating/cooling bulb. The Y circuit then takes the same path as described above, first stage heating (namely, in heating, from lockout relay terminals 4 to 2—now closed—to normally closed contacts 5 and 6 of the changeover relay to terminal V and then to the gas valve; in cooling normally closed contacts 5 and 6 of the changeover relay are open—coil energized—and the circuit to the gas valve is broken.

When refrigerant pressures equalize, the high (low) pressure switch automatically resets (pressure switch contacts close). However, the compressor contactor coil circuit is still interrupted at the lockout relay (terminals 4 and 5 open). The Y circuit is connected to X2 of the wall thermostat through a jumper. X2 of the thermostat is internally connected to L through the check light of the wall thermostat.

The check light circuit may be traced as follows: R through the heating/cooling bulb to Y. Y to X2 through the check light to L. L of the wall thermostat to L of the compressor section to 5 of the lockout relay (4 to 5 of the lockout relay open due to function of the high (low) pressure switch and lockout relay). Terminal 5 of the lockout relay to one side of the low pressure switch. Low pressure switch (refrigerant pressure equalized and pressure switch reset in closed position) to the high pressure switch (also closed or reset and closed) to 5 and 6 of the Fossil Fuel Relay and then to the contactor coil as a wire and back to the common side of the transformer. The check light circuit is complete and the light is on.

The check light does not come on until the lockout relay coil is energized, breaking the Y circuit at terminals 4 and 5 of the lockout relay. The check light will remain energized until the lockout relay is de-energized—system switch moved to OFF or the heat/cool thermostat bulb is satisfied.

5.0 SYSTEM START-UP PROCEDURE

5.1 Be sure main power to the unit is OFF at the disconnect.

5.2 Set thermostat system switch to OFF, fan switch to AUTO.

5.3 Move main power disconnect to ON. Power should be on to unit for a minimum of four hours or sixty minutes per pound of refrigerant. This allows the crankcase heater to drive any refrigerant liquid out of the compressor sump. This procedure should be followed whenever the power has been off for twelve hours or longer. Except as required for safety while servicing—**DO NOT OPEN THE UNIT DISCONNECT SWITCH.**

5.4 Check system air flow for obstructions.

5.4.1 Move thermostat fan switch to ON. Blower runs.

5.4.2 Be sure all registers and grilles are open.

5.4.3 Move thermostat fan switch to AUTO. Blower should stop.

5.5 Cooling cycle. *(NOTE: If unit is equipped with a heat recovery unit, temporarily disconnect the hot water circulating pump from the electrical circuit by moving pump switch to OFF).*

5.5.1 Open manual inlet and outlet water flow valves of the unit.

5.5.2 Move thermostat switch to COOL—fan should be set for AUTO.

5.5.3 Open the cooling regulating valve (V46AC) by turning range adjusting screw clockwise until the valve is fully open.

5.5.4 Turn the heating regulating valve screw clockwise (V46NC) until the valve is closed. Throttle manual outlet valve closed until rated water flow is achieved. An approximate flow rate may be determined by water pressure drop through the coil, Table 8.9. A more precise measure of water flow may be determined by timing the discharge from the pipe into a container of known volume, or by reading entering and leaving water temperatures and discharge pressure of the compressor. Compare the readings obtained with temperatures given in Figure 5 or 6 for temperature, and Table 8.13 or Table 8.14 for discharge pressure.

5.5.5 Check refrigerant suction and discharge pressures for cooling against Table 8.13 or 8.14. Variations in pressures of one or two pounds should be ignored. Larger variations should be checked for probable cause: Incorrect air or water flow; incorrect air or water temperature, incorrect refrigerant charge.

5.5.6 Adjust manual outlet valve to full open.

5.5.7 Adjust cooling regulating valve (V46AC) by turning range adjustment screw counterclockwise until water temperatures drop, Figure 5 or 6, and refrigerant pressures, Tables 8.13 or 8.14, all match.

5.5.8 Move thermostat switch to OFF. Check that cooling water regulating valve shuts off water.

5.6 Heating cycle heat recovery unit circulating pump should still be disconnected per step 5.5).

5.6.1 Manual inlet and outlet water flow valves of the unit should still be open per step 5.5.6.

5.6.2 Move thermostat switch to HEAT. Fan should be set for AUTO.

5.6.3 Open the heating regulating valve (V46NC) by turning the range adjusting screw counterclockwise until the entering water temperature and leaving water temperature compare to Figures 5 or 6 for the model installed. Compare suction pressure to Table 8.13 or 8.14 for the model installed.

5.6.4 Check refrigerant suction and discharge pressure for heating against Table 8.13 or 8.14. Variations in pressures of one or two pounds should be ignored. Larger variations should be checked for probable cause: Incorrect air or water flow; incorrect air or water temperature; incorrect refrigerant charge.

WQS30

COOLING GPM

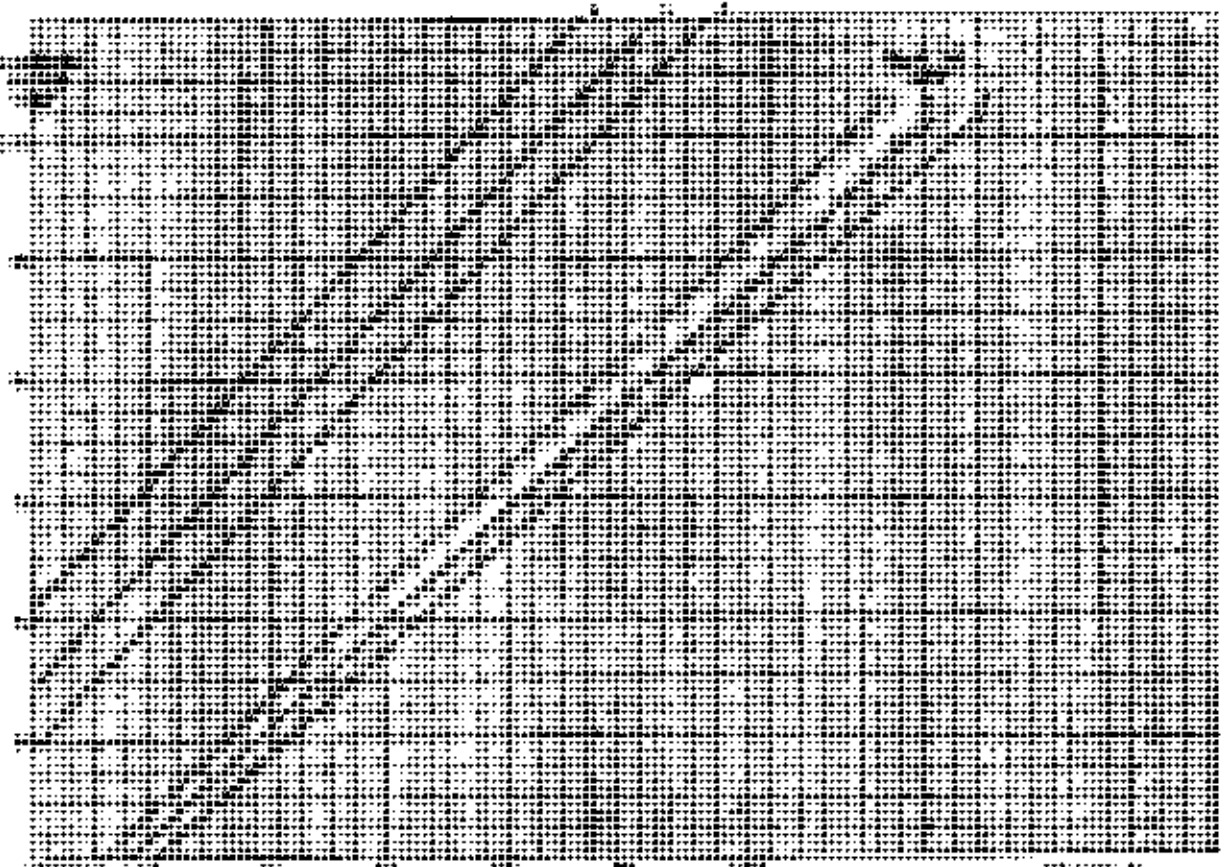

ENTERING WATER TEMP.

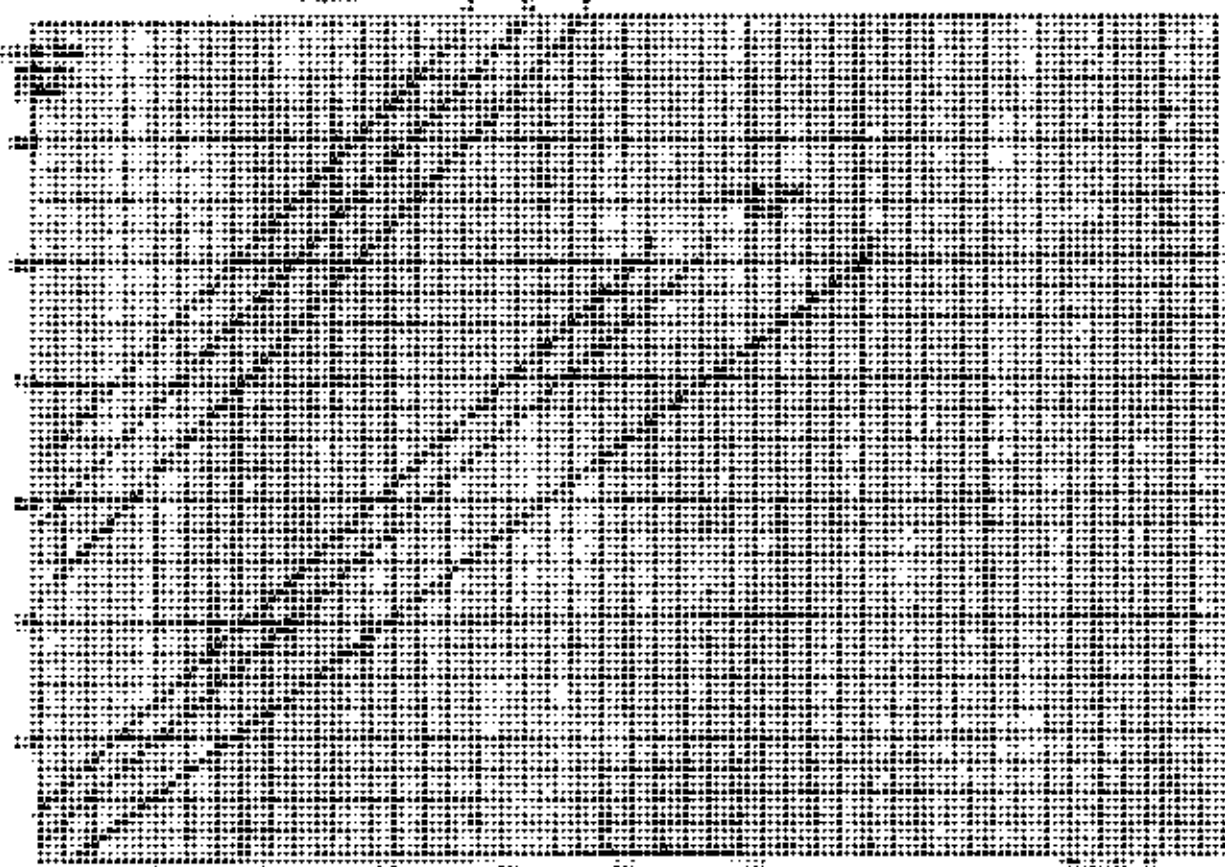

ENTERING WATER TEMP.

6.0 UNIT WITH HEAT RECOVERY FOR HEATING DOMESTIC HOT WATER --- MQSD SERIES

6.1 GENERAL

Units having a heat recovery coil should only be installed by trained refrigeration technicians. These instructions serve as a guide to the technician installing the heat recovery portion of the unit. They are not intended as a step-by-step procedure with which the mechanically inclined owner can install the unit.

6.2 DESCRIPTION

Units with the heat recovery coil mounted at the factory are designed to recover the "waste" heat from the compressor discharge gas and use this "waste" heat to heat domestic hot water. Units so equipped may be identified by the letter "D" in the model number. In addition to the components already described for the heat pump, these units are equipped with an additional water-to-refrigerant coil, a circulating pump and a thermostat to control the operation of the circulating pump. The water-to-refrigerant coil is constructed of two tubes. Water flows through the center tube, refrigerant flows through a surrounding tube, totally separated from the water tube. The space between these two tubes is vented to atmosphere. In the unlikely event a leak should develop, no leakage can occur between the water and the refrigerant.

6.3 WATER REQUIREMENTS

Units with the Heat Recovery Unit installed at the factory will have different water requirements, depending upon how much work the Heat Recovery Unit is doing. The actual amount of heat extracted by the recovery unit is a function of water flow rate (circulator pump) and temperature difference (into and out of the Heat Recovery Unit). Since this temperature difference will vary, depending upon domestic hot water usage, storage tank losses, etc., units with Heat Recovery Units **MUST EMPLOY WATER REGULATING VALVES** on the heat pump water system. Additionally, it should be pointed out that water flow requirements for the heat pump will increase in winter (from 5 gpm to as much as 13 gpm for a three ton heat pump) when the Heat Recovery Unit is operating. Conversely, in the cooling season the heat pump water flow requirements will decrease (from 5 gpm to approximately 3 gpm for a three ton unit) when the heat recovery unit is in operation.

6.4 INSTALLATION

6.4.1 TWO TANK. In order to realize the maximum energy savings from the domestic hot water heat recovery unit, it is recommended that a second water storage tank be installed in addition to the main hot water heater. Fossil fuel fired water heaters must be a two tank installation. If the existing water heater is electric, the two tank installation is still the best approach, however, a one tank installation is satisfactory. Tanks specifically intended for hot water storage are available from water heater manufacturers (solar hot water storage tanks). These tanks have special dip tube arrangements, are built without heaters and are constructed with heavier insulation. However, a well insulated electric water heater without the electric heating elements connected will also make a suitable storage tank.

The size of this tank should be as large as space and economy permit but in no event should it be less than one-half of the daily water requirements for the occupants. As a guide in estimating the daily family water requirements, the Department of Energy recommends a figure of 16.07 gallons of hot water per day per individual. For example, a family of four would require 64.3 gallons per day (4 x 16.07).

6.4.2 ONE TANK. Where space or first cost economy dictates only one hot water heater, a single tank installation is permissible. It should be noted, however, that the amount of savings realized is reduced.

The single hot water tank may be a new hot water heater (sized in this case to 100% of daily water requirements) or the existing water heater in the case of a retrofit installation. The existing hot water heater should be carefully inspected and any sediment removed by draining the water heater and flushing it until all loose sediment has been flushed away. This sediment, besides cutting down on the efficiency of the water heater and heat recovery unit, could damage the circulating pump, or clog the strainer and stop water flow.

6.5 LOCATION

In determining the location of the storage tank (and the water heater) keep in mind that small temperature differences between the storage tank water temperature and the refrigerant temperature permit this unit to function. It is consequently necessary that all tubing be kept as short and direct as possible and that the tubing be adequately and thoroughly insulated.

Locate the storage tank as close to the heat pump and water heater as the installation permits. Be sure to provide adequate service access to all components.

6.6 INSTALLATION PROCEDURE - GENERAL

6.6.1 Turn off the water heater electric power (if electric hot water heater) or close the fuel supply line (if fossil fuel water heater).

6.6.2 Shut off the main water supply line by closing the water valve at the wall pressure tank (if a well system) or the water meter (if city water is being used for domestic purposes).

6.6.3 Connect a garden hose to the water heater drain valve (bottom of the water heater tank) and drain the water heater to a floor drain or other convenient drain.

6.6.4 If the water heater has been in service for some time, inspect it for sediment. Remove all sediment and thoroughly flush the water heater tank.

6.6.5 Turn off the electric power to the water source heat pump.

6.7 WATER PIPING

Two tank installation, refer to Piping Diagram, Figure 7 and steps 6.7 to 6.7.3 and 6.8 to 6.8.6. One tank installation, refer to Piping Diagram, Figure 8 and steps 6.7 to 6.7.3 and 6.9 to 6.9.4. Follow all local plumbing codes. Piping connections are 1/2 inch O.D. copper pipe, Type K or L, and are made inside the unit. Route the copper through the top of the heat pump through the holes provided.

6.7.1 A plugged tee and shut off valve should be provided near the heat pump unit. This will make it easy if it ever becomes necessary to clean the desuperheater coil. A suitable cleaner is mentioned below, "Water Corrosion" section. The shut off valves will isolate the unit from the rest of the plumbing and the plugged tees will provide access to the coil and pump for the cleaner.

6.7.2 A strainer is included in both figures to collect any sediment which may accumulate in the storage tank or water heater. This strainer should be of the cleanable "Y" type. It is more important that the strainer be included on one tank retrofit installation where the hot water heater may be susceptible of sedimentation.

6.7.3 A check valve is shown in both figures as an option. The purpose of the check valve is to prevent any contamination of the water system in the unlikely event that the heat exchanger develops a leak. Check the local plumbing code as this check valve may be required.

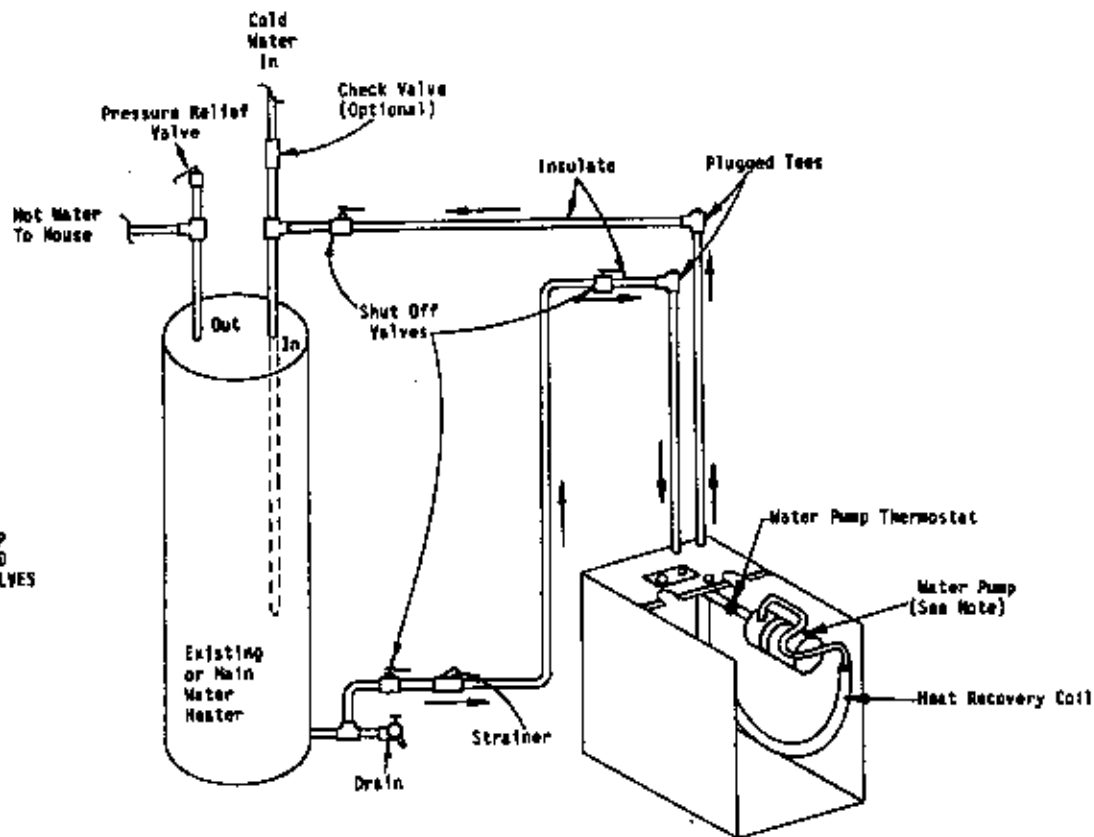

NOTE: DO NOT OPERATE WATER PUMP WITHOUT WATER LINES CONNECTED AND WATER IN SYSTEM WITH SHUT OFF VALVES OPEN! TURN PUMP SWITCH TO OFF.

TYPICAL "WQSD" MODEL ONE TANK INSTALLATION (PERMISSIBLE)

Figure 6

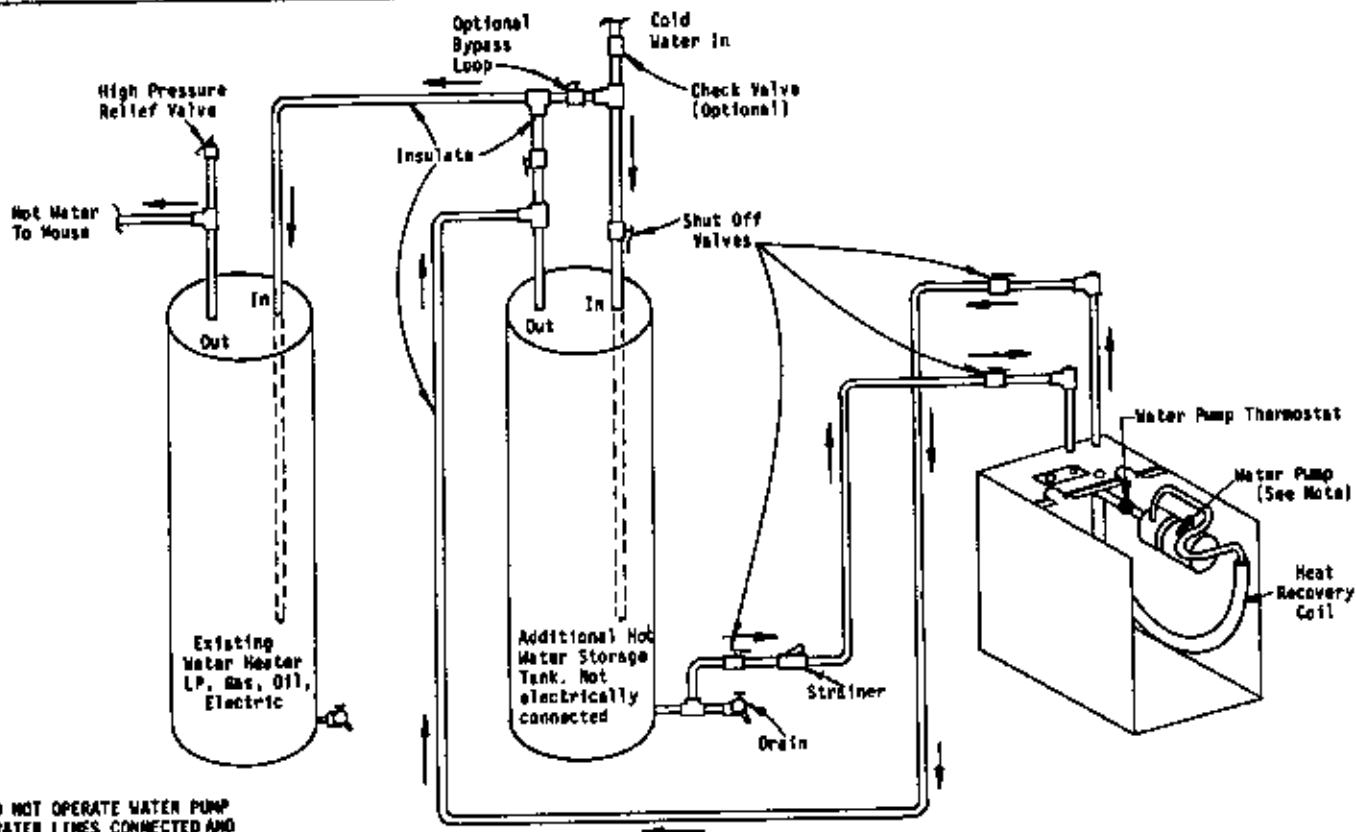

NOTE: DO NOT OPERATE WATER PUMP WITHOUT WATER LINES CONNECTED AND WATER IN SYSTEM WITH SHUT OFF VALVES OPEN! TURN PUMP SWITCH TO OFF.

TYPICAL "WQSD" MODEL TWO TANK INSTALLATION (PREFERRED)

Figure 7

6.8 TWO TANK INSTALLATION - FIGURE 7

6.8.1 Water into the heat recovery unit is taken from the bottom of the storage tank. This location will insure that the coldest water will always be circulated to the recovery unit.

6.8.2 If a solar type water storage tank is being used (specifically designed for storing but not heating water), insert the dip tubes according to the manufacturer's instructions.

6.8.3 If a second water heater is being used for storage, install a pipe thread tee and a suitably sized pipe nipple in the water heater drain connection (bottom of the tank). The run of the tee is connected between the water heater and a drain valve. Brass or bronze fittings are recommended for these fittings. Check the local plumbing code—brass or bronze may be required. The branch of the tee is connected to the recovery unit "water in" copper tube. Use a pipe thread to sweat adapter to connect the tubing between the tee and recovery unit.

6.8.4 The "water out" tubing from the recovery unit is connected through a tee to the storage tank and to the normal "water in" of the main water heater.

6.8.5 Cold water into the storage tank is connected to the "water in" of the storage tank.

6.8.6 An optional bypass loop with valve is shown in Figure 7 between the water into the storage tank and the "water out" of the storage tank. The loop will make future service work easier should it become necessary to drain the storage tank. In normal operation the valve in the bypass loop should be closed.

6.9 ONE TANK INSTALLATION, FIGURE 8 NOT RECOMMENDED FOR FOSSIL FUEL FIRED WATER HEATER

6.9.1 Unless the single hot water heater is new, it should be thoroughly inspected and cleaned of sediment. Flush the tank several times and inspect it after each flushing. Be sure the tank is free of sedimentation.

6.9.2 Water from the hot water heater is connected to the domestic hot water supply as any conventional hot water heater would be connected.

6.9.3 Water to the heat recovery unit is connected through a tee at the drain valve connection of the hot water heater as described in step 6.8.3 above.

6.9.4 Water from the recovery unit is connected at the "water in" connection of the hot water heater through a tee.

6.10 OPERATION OF THE HEAT RECOVERY UNIT

The circulating pump is wired in parallel with the heat pump compressor (230 VAC circuit). Thus, no water can be circulated to the water-to-refrigerant coil unless the compressor is in operation.

In addition, a thermostat, attached to the entering water tube of the pump, is wired in series with the pump motor. The thermostat is normally closed and opens when the tube temperature reaches 150°F. This will stop further heating of the water by the recovery unit and is intended to prevent overheating the water. The thermostat will reset at approximately 120°F.

Heat for domestic hot water is obtained from the discharge gas of the compressor. This heat would ordinarily be rejected to the ground water in the cooling mode or to the room air in the heating mode. With the recovery unit this heat is transferred to the storage tank or water heater.

6.11 START UP AND CHECK OUT

6.11.1 Be sure all shut off valves are open. If optional bypass valve, see Figure 7, has been installed, this valve should be closed.

6.11.2 Open a hot water faucet to permit any air to bleed from the plumbing.

6.11.3 Turn off the heat pump disconnect.

6.11.4 Temporarily remove compressor wire from load side of contactor and insulate.

6.11.5 Turn heat pump disconnect ON.

6.11.6 Set the wall thermostat to cool.

6.11.7 Inspect for water leaks and verify pump is operating.

6.11.8 Again turn off the heat pump disconnect.

6.11.9 Re-install compressor wire on compressor contactor terminal.

6.11.10 Repeat steps 6.11.5 and 6.11.6. Feel the "water in" and "water out" tubes. There should be a noticeable temperature difference. How much temperature difference you measure will depend upon tubing length, flow rate, storage tank temperature and could vary from 2°F to 20°F.

6.11.11 Move thermostat system to OFF. Verify that water pump stops.

7.0 WATER CORROSION

Two concerns will immediately come to light when considering a water source heat pump, whether for ground water or for a closed loop application: Will there be enough water? And, how will the water quality affect the system?

Water quantity is an important consideration and one which is easily determined. The well driller must perform a pump down test on the well according to methods described by the National Well Water Association. This test, if performed correctly, will provide information on the rate of flow and on the capacity of the well. It is important to consider the overall capacity of the well when thinking about a water source heat pump because the heat pump may be required to run for extended periods of time.

The second concern, about water quality, is equally important. Generally speaking, if the water is not offensive for drinking purposes, it should pose no problem for the heat pump. The well driller or local water softening company can perform tests which will determine the chemical properties of the well water.

Water quality problems will show up in the heat pump in one or more of the following ways:

1. Increased water flow to the unit.
2. Decreased heat transfer of the water coil (entering to leaving water temperature difference is less).

There are four main water quality problems associated with ground water. These are:

(1) Biological growth. This is the growth of microscopic organisms in the water and will show up as a slimy deposit throughout the water system. Shock treatment of the well is usually required and this is best left up to the well driller. The treatment consists of injecting chlorine into the well casing and flushing the system until all growth is removed.

(2) Suspended particles in the water. Filtering will usually remove most suspended particles (fine sand, small gravel) from the water. The problem with suspended particles in the water is that it will erode metal parts, pumps, heat transfer coils, etc. So long as the filter is cleaned and periodically maintained, suspended particles should pose no serious problem. Consult with your well driller.

(3) Corrosion of metal. Corrosion of metal parts results from either highly corrosive water (acid water, generally not the case with ground water) or galvanic reaction between dissimilar metals in the presence of water. By using plastic plumbing or di-electric unions galvanic reaction is eliminated. The use of corrosion resistant materials (such as the Cupro nickel coil) throughout the water system will reduce corrosion problems significantly.

(4) Scale formation. Of all the water problems, the formation of scale by ground water is by far the most common. Usually this scale is due to the formation of calcium carbonate but magnesium carbonate or calcium sulfate may also be present. Carbon dioxide gas (CO₂), the carbonate of calcium and magnesium carbonate, is very soluble in water. It will remain dissolved in the water until some outside factor upsets the balance. This outside influence may be a large change in water temperature or pressure. When this happens, enough carbon dioxide gas combines with dissolved calcium or magnesium in the water and falls out of solution until a new balance is reached. The change in temperature that this heat pump produces is usually not high enough to cause the dissolved gas to fall out of solution. Likewise if pressure drops are kept to a reasonable level, no precipitation of carbon dioxide should occur.

7.1 REMEDIES OF WATER PROBLEMS

WATER TREATMENT. Water treatment can usually be economically justified for closed loop systems. However, because of the large amounts of water involved with a ground water heat pump, water treatment is generally too expensive.

ACID CLEANING THE WATER COIL OR HEAT RECOVERY UNIT.

If scaling of the coil is strongly suspected, the coil can be cleaned up with a solution of Sulfamic Acid (toxic) or Phosphoric Acid (food grade acid). Follow the manufacturer's directions for mixing, use, etc. Refer to the, Cleaning Water Coil, Figure 9. The acid solution can be introduced into the heat pump coil through the hose bib (Part 8 of Figure 9.) Be sure the isolation valves (Parts 9 and 11 of Figure 9) are closed to prevent contamination of the rest of the system by the coil. The acid should be pumped from a bucket into the hose bib (Part 8, Figure 9) and returned to the bucket through the other hose bib (Part 10, Figure 9). Follow the manufacturer's directions for the product used as to how long the solution is to be circulated, but it is usually circulated for a period of several hours.

UNDER NO CIRCUMSTANCES SHOULD THE HEAT PUMP BE OPERATED IN SUCH A WAY AS TO FREEZE THE COIL IN AN ATTEMPT TO BREAK SCALE FREE.

While no damage is expected to be done to the coil from freezing, undue strain is put on the refrigeration system and this practice should not be attempted.

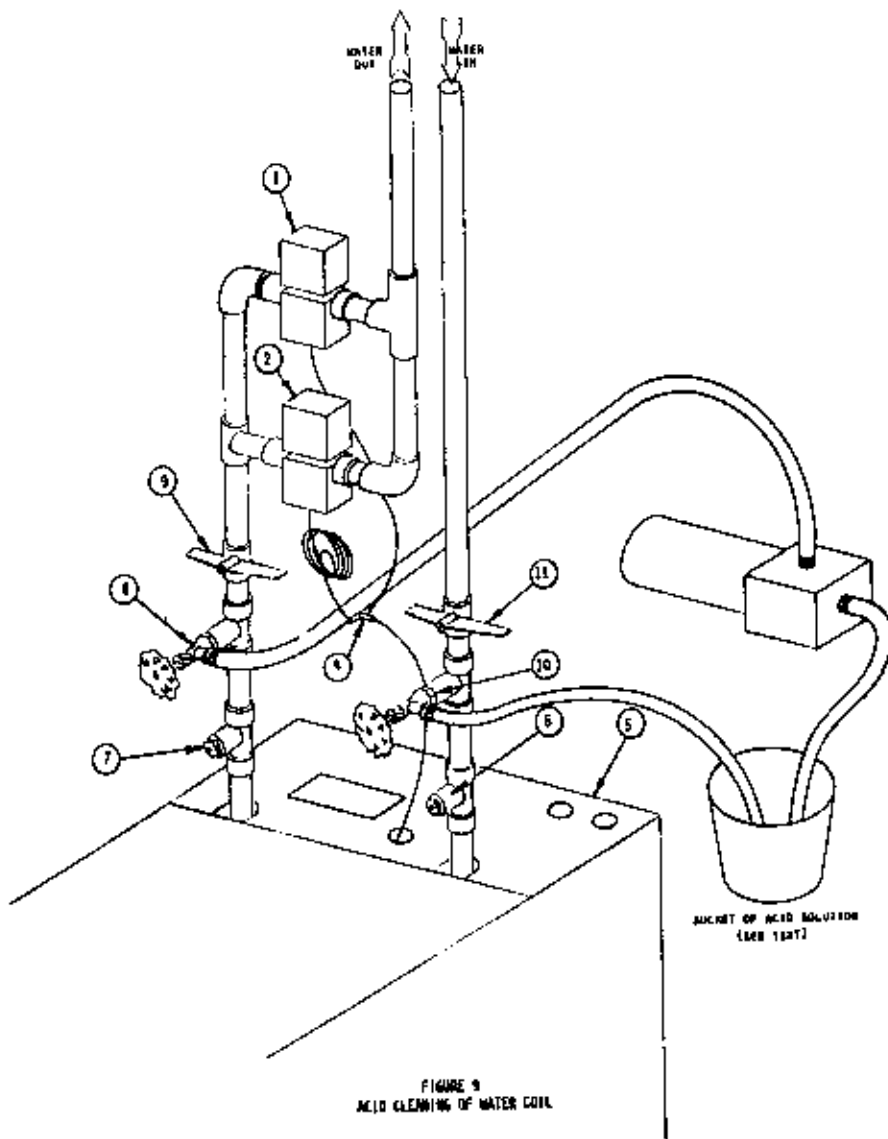







TABLE 8.13

WQS30 OR WQSD30 W/H3AQ OR B36EHQ1

COOLING 

BWT °F	Low Side Suction PSIG @ Compressor			High Side Liquid Line Pressure 		
	4 GPM	5 GPM 	7 GPM	4 GPM	5 GPM 	7 GPM
	45	68-70	64-66	62-64	135-140	126-131
50	71-75	68-70	65-67	143-148	133-138	128-133
55	74-76	71-73	68-70	153-158	143-148	137-142
60	75-77	74-76	72-74	165-170	155-160	148-153
65	77-79	76-78	73-75	178-183	167-172	160-165
70	78-80	77-79	75-77	190-195	181-186	174-179
75	78-80	78-80	75-77	203-208	196-211	185-190

HEATING 

BWT °F	4 GPM	5 GPM 	7 GPM	4 GPM	5 GPM 	7 GPM
	45	51-53	53-55	54-56	187-192	188-193
50	55-57	56-58	57-59	192-197	193-198	194-199
55	59-61	61-63	62-64	195-200	197-202	199-204
60	61-63	64-66	65-67	200-205	201-206	203-208
65	65-67	67-69	68-70	204-209	205-210	207-212
70	67-69	69-71	71-73	208-213	210-215	212-217
75	71-73	72-74	74-76	211-216	213-218	216-221







-  At rated air flow and 80°DB/67°WB return air temperature.
-  At rated air flow and 70°DB return air temperature.
-  Liquid line pressure at quick connect coupling of line set.
-  Rated water flow on WQSD models - pressures apply only when heat recovery circulating pump is turned off.



TABLE 8.14

WQS36 OR WQSD36 W/H3AQ OR B36EHQ1

COOLING 

BWT °F	Low Side Suction PSIG @ Compressor			High Side Liquid Line Pressure 		
	4 GPM	5 GPM 	7 GPM	4 GPM	5 GPM 	7 GPM
	45	61-64	59-61	53-55	155-160	126-131
50	64-66	61-63	56-58	146-151	137-142	124-129
55	66-68	63-65	58-60	158-163	148-153	136-141
60	68-70	64-67	61-63	170-175	159-164	147-152
65	70-72	67-69	64-66	183-188	173-178	159-164
70	72-74	70-72	67-69	198-203	185-190	172-177
75	74-76	72-74	69-71	210-215	199-204	184-189

HEATING 

BWT °F	4 GPM	5 GPM 	7 GPM	4 GPM	5 GPM 	7 GPM
	45	45-47	48-50	52-54	190-195	193-198
50	52-54	54-56	56-58	200-205	206-211	206-211
55	56-58	58-60	59-61	208-213	212-217	222-227
60	59-61	62-64	63-65	214-219	218-223	219-224
65	63-65	66-68	67-69	221-226	223-228	225-230
70	67-69	69-71	69-71	227-232	228-233	230-235
75	70-72	73-75	73-75	231-236	233-238	236-241





-  At rated air flow and 80°DB/67°WB return air temperature.
-  At rated air flow and 70°DB return air temperature.
-  Liquid line pressure at quick connect coupling of line set.
-  Rated water flow on WQSD models - pressures apply only when heat recovery circulating pump is turned off.

TABLE 8.2

WATER REGULATING VALVES

MODEL	VALVE SIZE	COOLING VALVE	HEATING VALVE
WQS30 WQSD30 WQS36 WQSD36	3/4"	8603-001	8603-002

TABLE 8.9

WATER COIL PRESSURE DROP

MODEL	WQS30-WQSD30		WQS36-WQSD36	
	Psig	Ft. Hd.	Psig	Ft. Hd.
4	2.0	4.6	1.9	4.4
5	3.0	6.9	2.0	4.6
6	4.2	10.0	2.4	5.5
7	5.7	13.1	3.0	6.9
8	7.5	17.3	3.9	9.0
9	9.5	21.9	5.5	12.7
10	12.0	27.7	7.6	17.5
11	14.8	34.1	10.4	24.0
12	17.6	40.6	15.3	35.3
13	20.3	46.8	20.6	47.5

TABLE 8.5

WATER COIL RATED FLOW

MODEL	GPM
WQS30	5
WQSD30	9.2
WQS36	5
WQSD36	10.0

REFRIGERANT CHARGE TABLE

	WQS30	WQSD30	WQS36	WQSD36
Water Coil Section	50 oz	52 oz	59.5 oz	61.5 oz
Tubing Set 35' *	3 oz	3 oz	3 oz	3 oz
B36EHQ1	8 oz	8 oz	8 oz	8 oz
H3AQ	10 oz	10 oz	10 oz	10 oz

* For other length tubing sets see Manual 2100-002C.

9.0 INSTALLING REFRIGERANT TUBING

PRE-CHARGED TUBING - Examine carefully the two lengths of pre-charged tubing furnished with the unit. The larger is the suction line. The smaller is the liquid line. The end of the tubing with the hex nut and gauge port is to be attached to the condensing unit.

Roll the tubing, being careful not to kink, and install it between the condensing unit and the evaporator coil.

CAUTION: Be careful not to tear the insulation when pushing it through holes in masonry or frame walls.

When sealing tube opening in house wall use a soft material to prevent tube damage and vibration transmission.

Before fastening either end, use a tubing bender to make any necessary bends in the tubing. (AVOID EXCESSIVE BENDING IN ANY ONE PLACE TO AVOID KINKING).

Start connecting the tubing at the evaporator coil end, first remove the protective caps and plugs from the quick connect fittings on the evaporator coil and the pre-charged tubing. Inspect fittings and clean if necessary, making sure they are clear of foreign materials. If you clean the fittings, lubricate them with refrigeration oil. Connect both tubes to the fittings on the coil and draw up by hand.

When necessary to bend the insulated tube, suction line, cut the insulation around its circumference at a distance far enough beyond the point of the bend so as to clear the tubing bender.

Slip the insulation back together and vapor seal the joint with tape.

NOTE: The maximum distance for pre-charge tubing between the condenser and the evaporator is 45 feet.

CAUTION: Prior to connecting the pre-charged tubing to the evaporator coil or condensing unit, be sure all bends have been made, then coil any excess tubing in a horizontal plane, with the slope of the tubing toward the condensing unit.

CAUTION: Be sure to hold the coupling firmly to prevent movement of the coupling and tubing. Failure to do so could tear out the diaphragm causing a blockage of the system.

CAUTION: After starting to tighten up the fitting never try to back it off or take it apart.

For connecting the tubing at the condensing unit end, first remove the protective caps and plugs from the quick-connect fittings on the condensing unit and the pre-charged tubing. Inspect fittings and clean if necessary, making sure they are clear of foreign materials. If you clean the fittings, lubricate them with refrigeration oil. Connect both tubes to the fittings on the coil and draw up by hand.

Locate the gauge port in a 45° angle from a vertical up position so as to be accessible for gauge connections.

Use a wrench on the hex nut of the female fitting backing up the fitting with another wrench to keep tube from turning. Tighten the fittings together until they bottom out then tighten for an additional 1/4 turn so that coupling will seat properly.

Check the gauge port cap to make sure it is tight. If loose, tighten, being careful not to tighten too much as it will damage the valve in the gauge port.

Leak test all connections using an Electronic Leak Detector or a Halide Torch.

When tubing is installed in attics or drop ceiling, insulate the quick connect fitting on the larger tube thoroughly with 3/8 inch wall thickness, closed cell sponge tube insulation or equivalent. Failure to insulate will result in water damage to ceiling since the fitting will "sweat" and drop water on the ceiling.

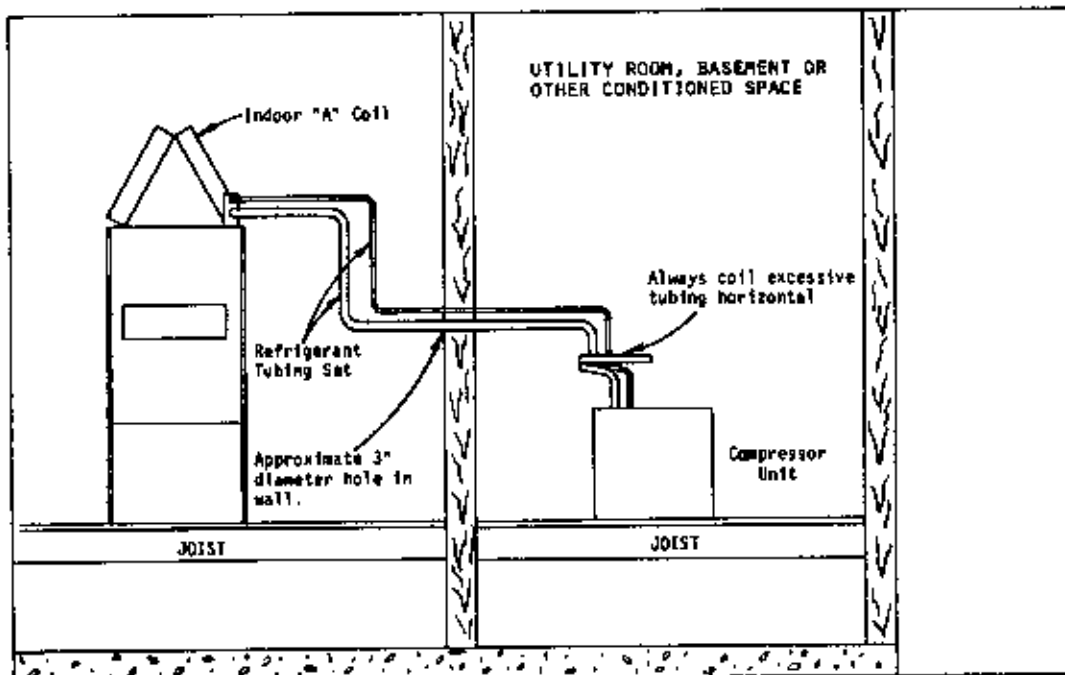

TYPICAL R-22 INSTALLATION
(SHOWN WITH "A" COIL ON A FURNACE)

PARTS LIST
 WATER SOURCE
 SPLIT HEAT PUMPS

PART NO.	DESCRIPTION	MQS30	MQS030	MQS36	MQS036
8552-040	Capacitor - Compressor 20/15-370V	X	X		
8552-036	Capacitor - Compressor 40/370V			X	X
5811-033	Capillary Tube - Heating	(2)	(2)		
5811-017	Capillary Tube - Heating			(2)	(2)
5651-006	Check Valve	X	X	X	X
8000-071	Compressor AB225HT-015-A4	X	X		
8000-052	Compressor CR01-0250-PFV-270			X	X
5052-001	Condenser Coil	X	X		
5052-002	Condenser Coil			X	X
8401-007	Contact - Compressor	X	X	X	X
5052-003	Desuperheater Coil			X	X
8406-016	High Pressure Switch	X	X	X	X
8406-015	Low Pressure Switch	X	X	X	X
8201-015	Relay - Staging and Changeover	(2)	(2)	(2)	(2)
8201-037	Relay - Lockout	X	X	X	X
5650-005	Reversing Valve	X	X		
5650-009	Reversing Valve			X	X
5650-008	Reversing Valve Solenoid	X	X	X	X
5210-004	Strainer - Heating	X	X	X	X
8607-011	Terminal Board - 24V	X	X	X	X
8300-001	Water Pump 230v		X		X
8408-007	Water Pump Thermostat		X		X

THERMOSTAT-SUBBASE

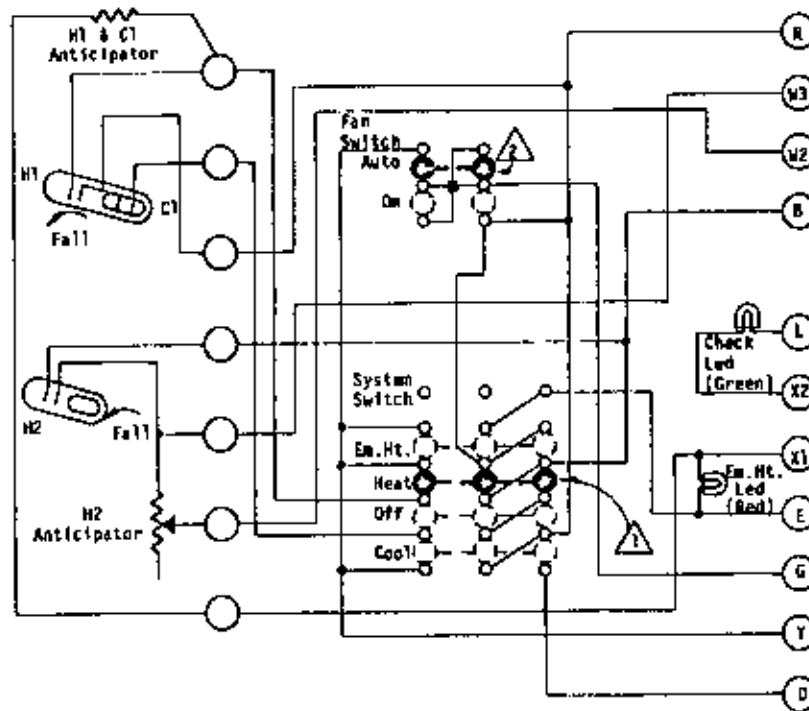

T874R1129/0674L1181

- ⚠ System switch shown in "Heat" position.
- ⚠ Fan switch shown in "Auto" position.

WQS36, WQSD36

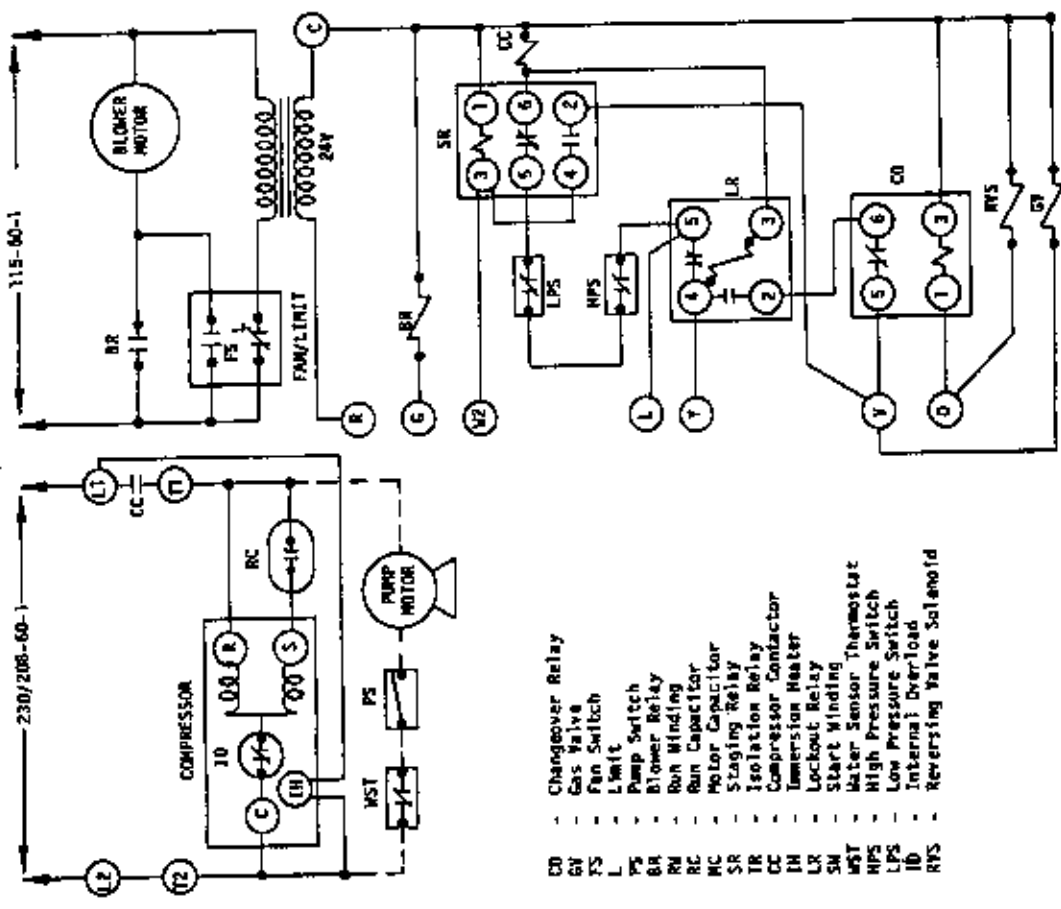

- Changeover Relay
- Gas Valve
- Fan Switch
- Limit
- Pump Switch
- Blower Relay
- Run Winding
- Run Capacitor
- Motor Capacitor
- Staging Relay
- Isolation Relay
- Compressor Contactor
- Immersion Heater
- Lockout Relay
- Start Winding
- Water Sensor Thermostat
- High Pressure Switch
- Low Pressure Switch
- Internal Overload
- Reversing Valve Solenoid

WQS30, WQSD30

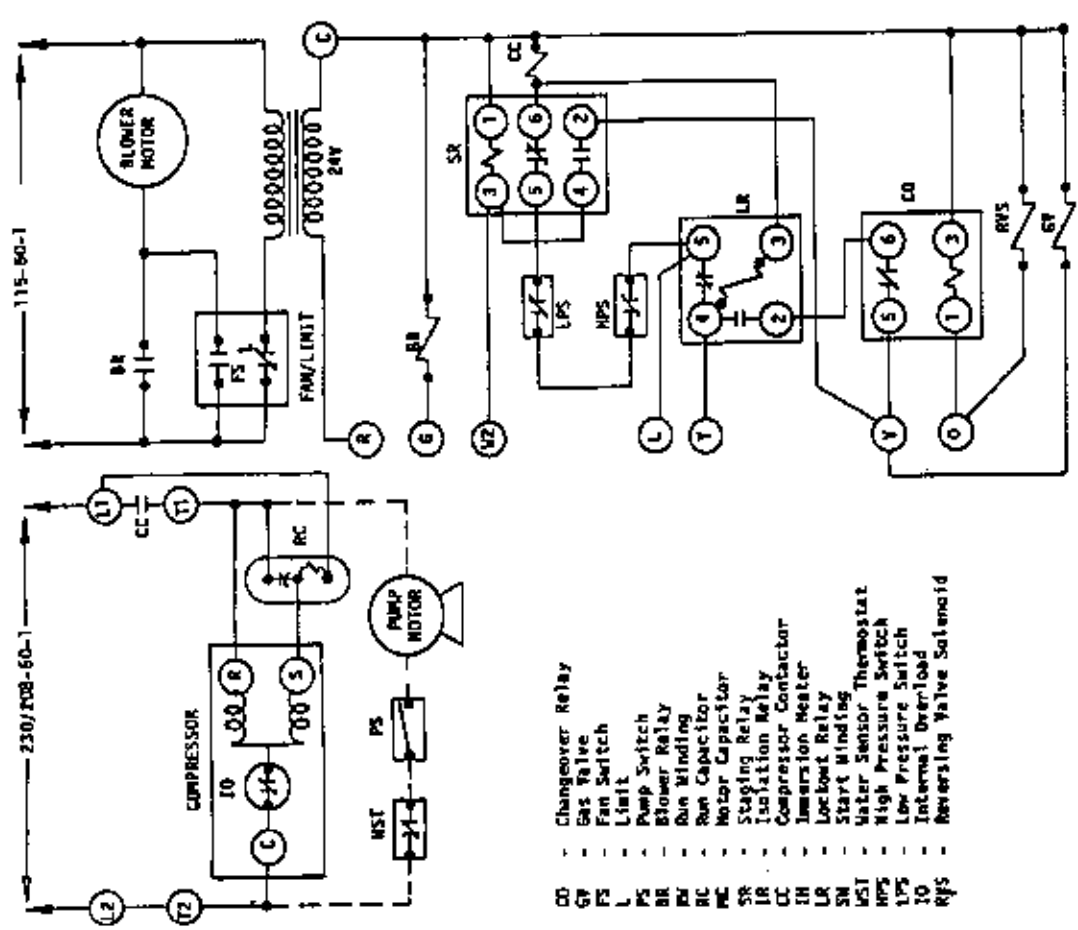

- Changeover Relay
- Gas Valve
- Fan Switch
- Limit
- Pump Switch
- Blower Relay
- Run Winding
- Run Capacitor
- Motor Capacitor
- Staging Relay
- Isolation Relay
- Compressor Contactor
- Immersion Heater
- Lockout Relay
- Start Winding
- Water Sensor Thermostat
- High Pressure Switch
- Low Pressure Switch
- Internal Overload
- Reversing Valve Solenoid

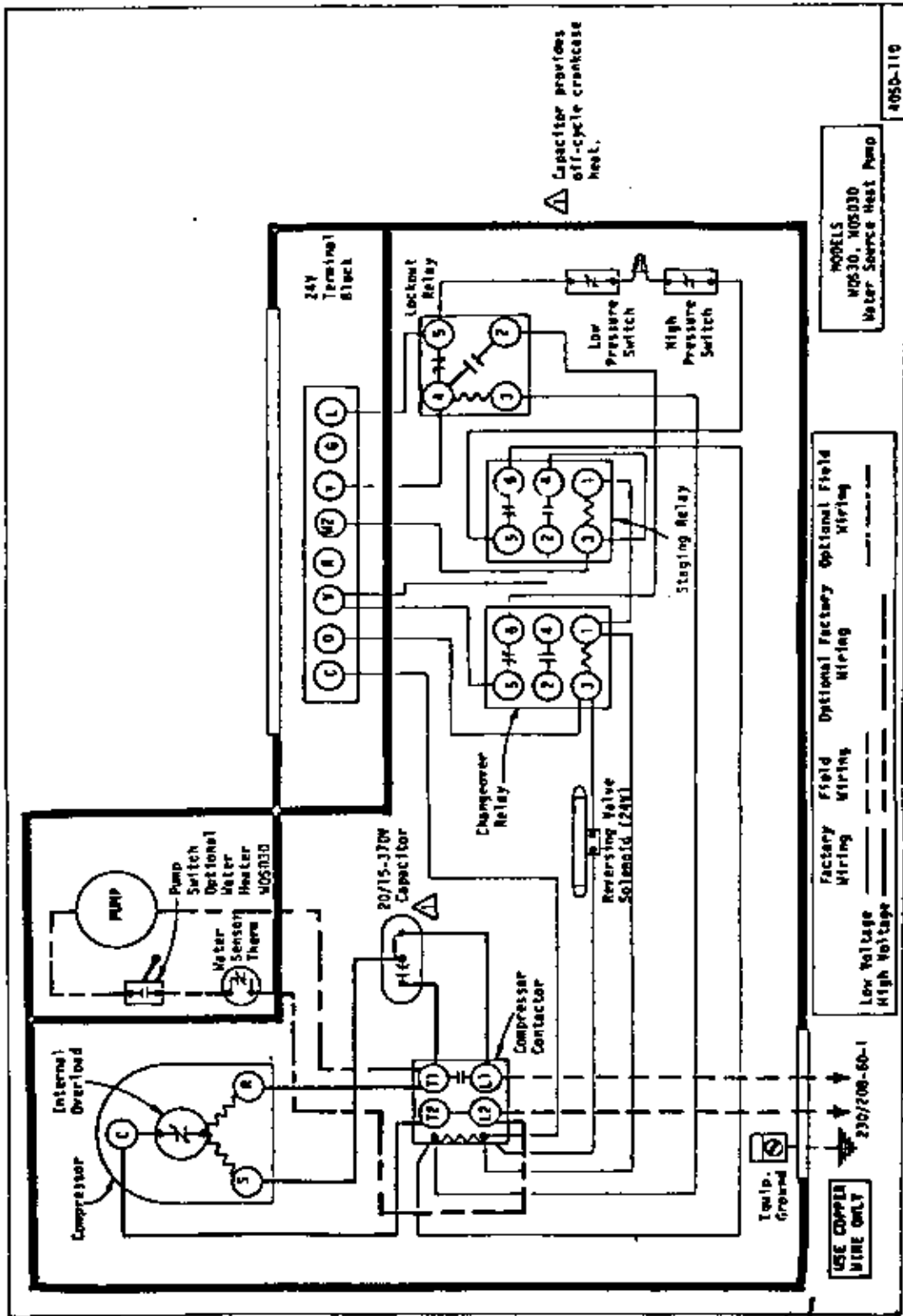

MODELS
N0530, N0533
Water Source Heat Pump

Low Voltage	Factory Wiring	Field Wiring	Optional Factory Wiring	Optional Field Wiring
High Voltage	_____	_____	_____	_____

405D-110

Get a lot of programs

WMM

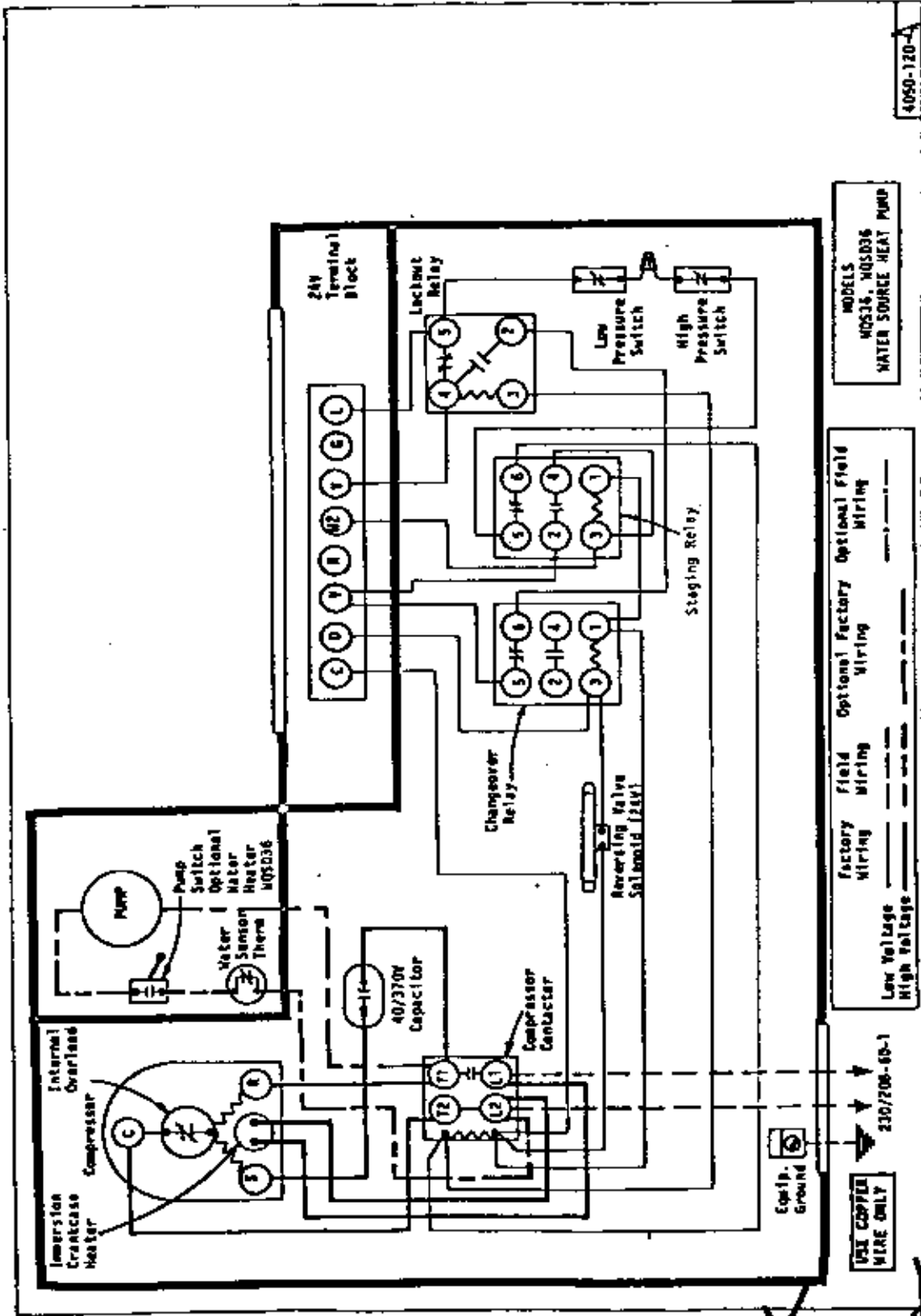

Set up diagrams

Factory Wiring	Field Wiring	Optional Factory Wiring	Optional Field Wiring
---	---	---	---
---	---	---	---
---	---	---	---

**TYPICAL CONNECTION TO EFC AND EFC-1
ELECTRIC FURNACES**

▲ Add jumper W1-W2 for 15, 20, 25kw models (EFC-1 only).
▲ Add jumper W2-F for 25kw models (EFC-1 only).

7874R1129/G674L1181
1-Stat Terminals

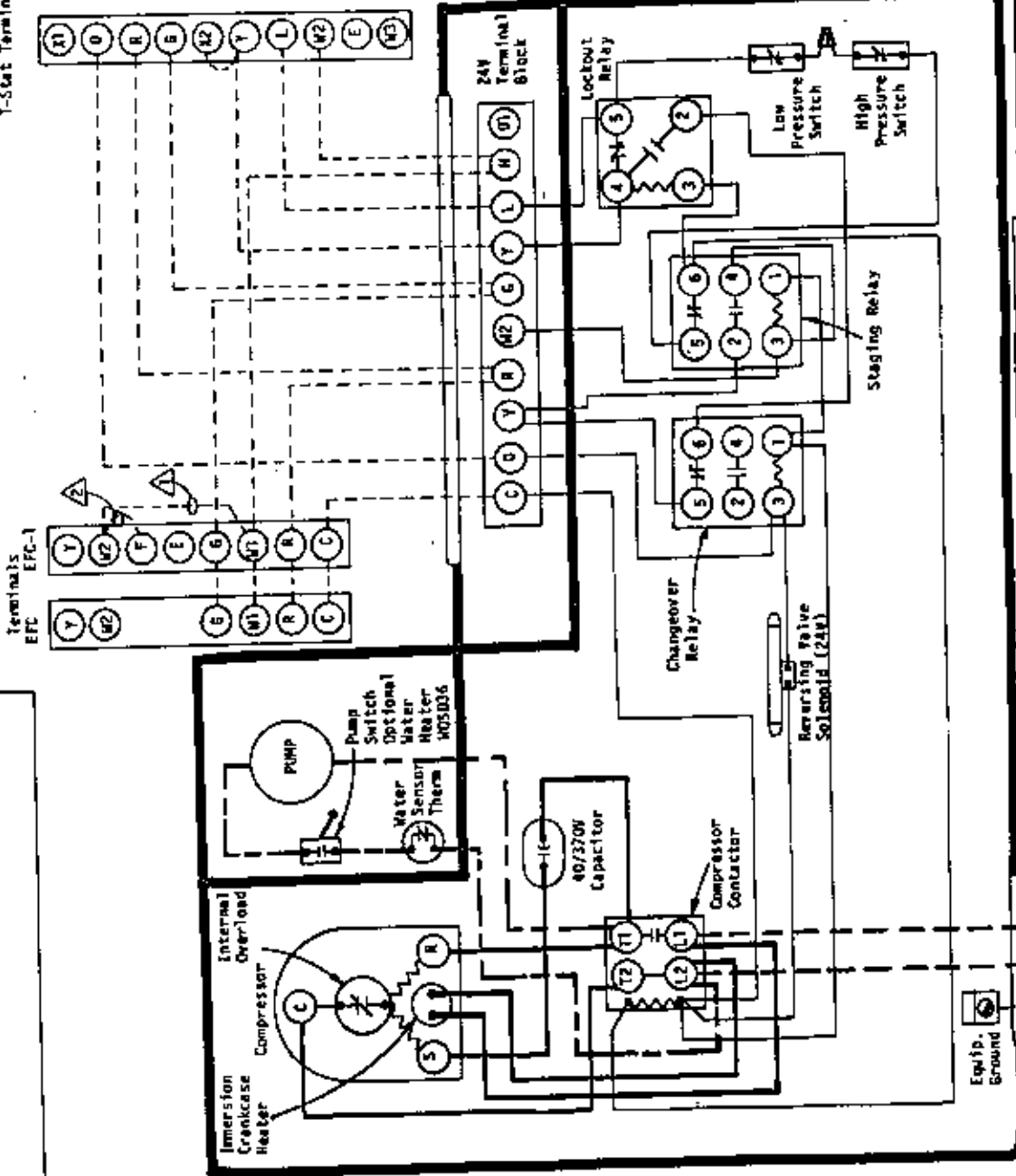

MODELS
W0536, W05036
WATER SOURCE HEAT PUMP

Factory Wiring Field Wiring Optional Factory Wiring Optional Field Wiring

USE COPPER WIRE ONLY

Low Voltage
High Voltage

230/208-50-1

Add Jumper W2-W3 on 15, 20, 25 and 30kW (B36EHQ1 only)
 Add Jumper W1-W2 on 25 and 30kW (B36EHQ1 only)

TYPICAL CONNECTION TO B36EHQ1 AND B36EHQ2

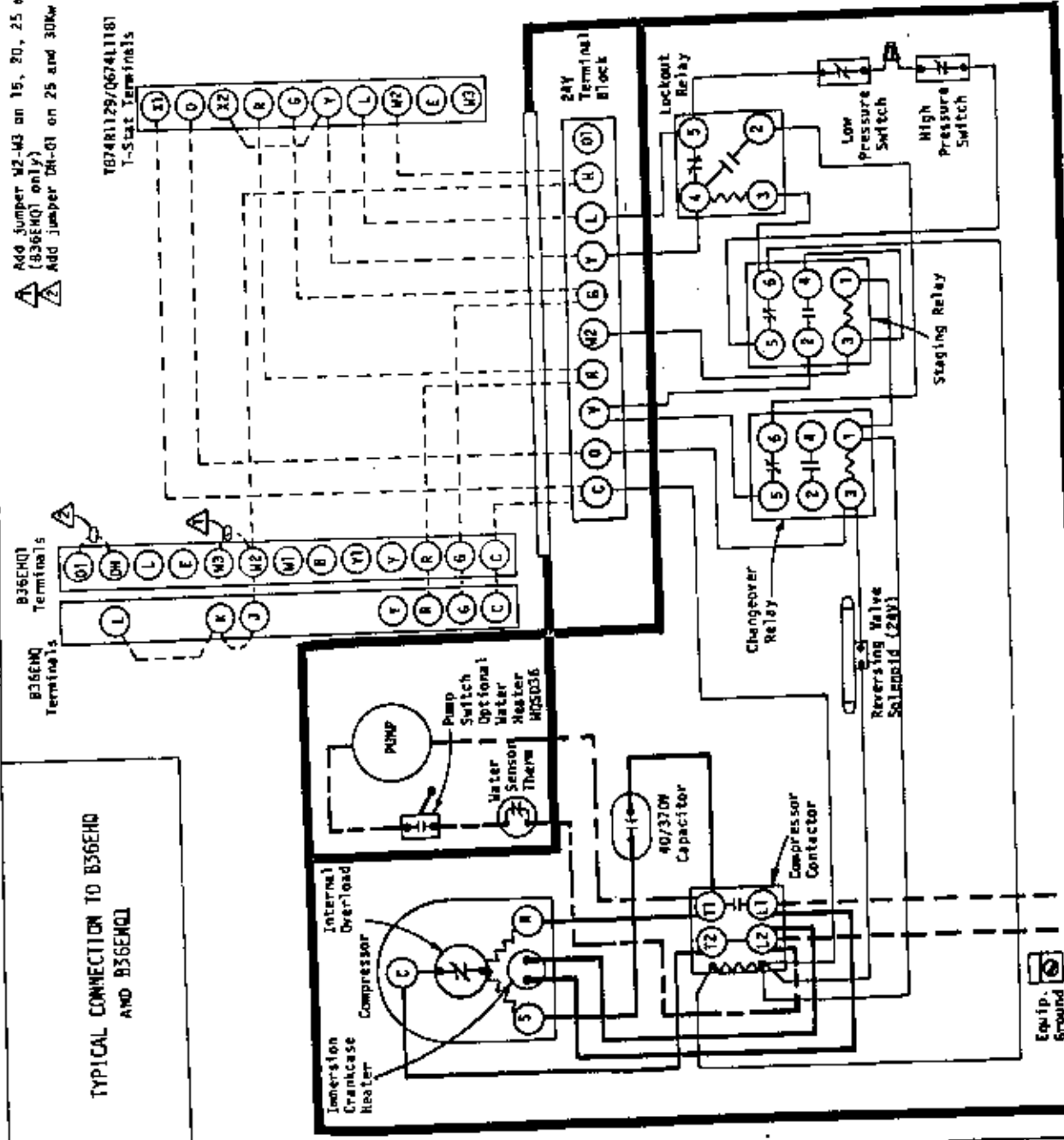

MODELS
 WQ536, WQ5036
 WATER SOURCE HEAT PUMP

Low Voltage _____
 High Voltage _____
 Factory Wiring _____
 Field Wiring _____
 Optional Factory Wiring _____
 Optional Field Wiring _____

USE COPPER WIRE ONLY
 230/208-60-1

TYPICAL CONNECTION TO GAS FURNACE

TB74R1129/0674Q1181
T-Stat Terminals

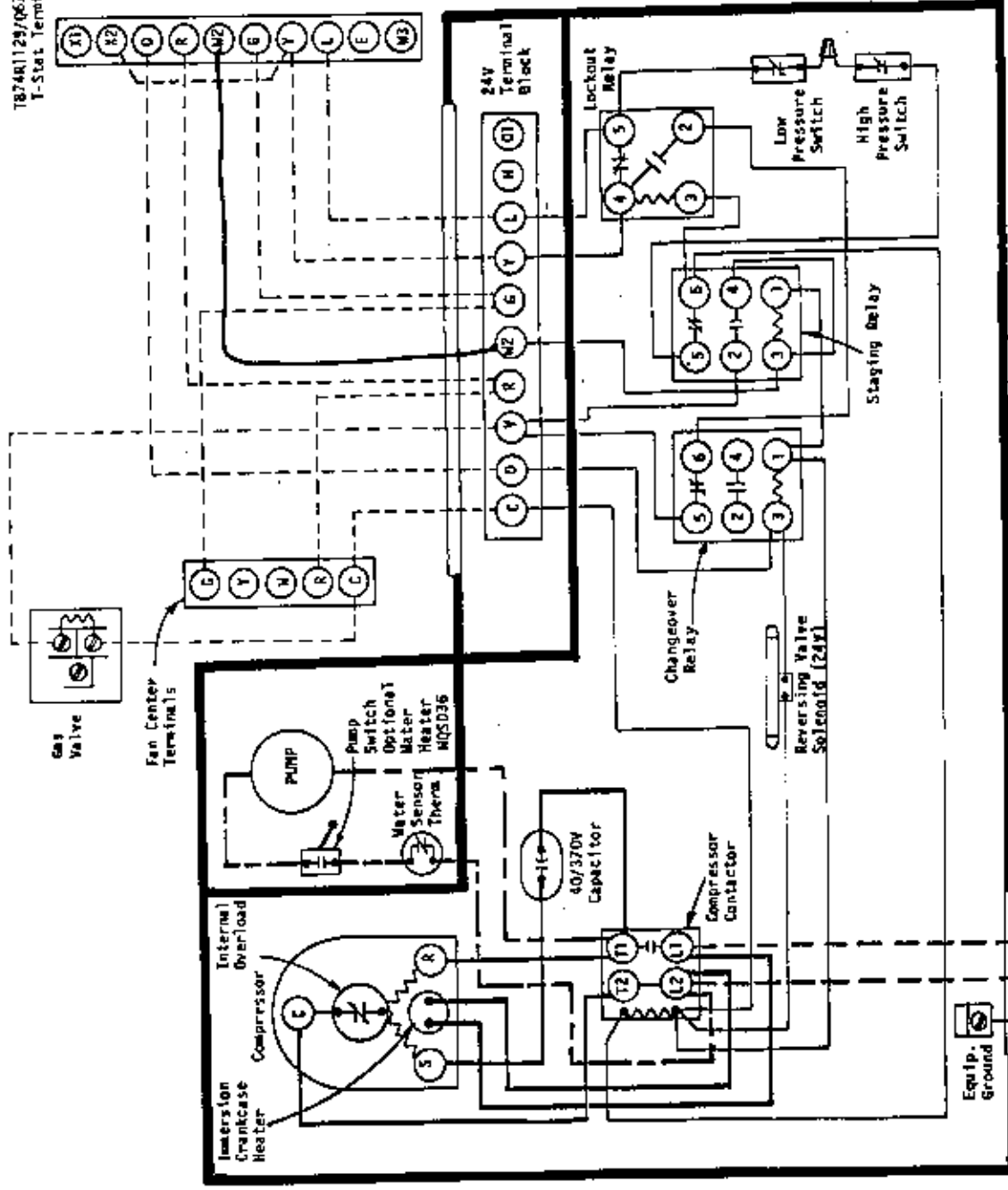

MODELS
MQ336, MQ336G
WATER SOURCE HEAT PUMP

Factory Wiring
Field Wiring
Optional Factory Wiring
Optional Field Wiring

Low Voltage
High Voltage

USE COPPER WIRE ONLY
230/208-60-1

Equip. Ground

Replace

TYPICAL CONNECTION TO OIL FURNACE

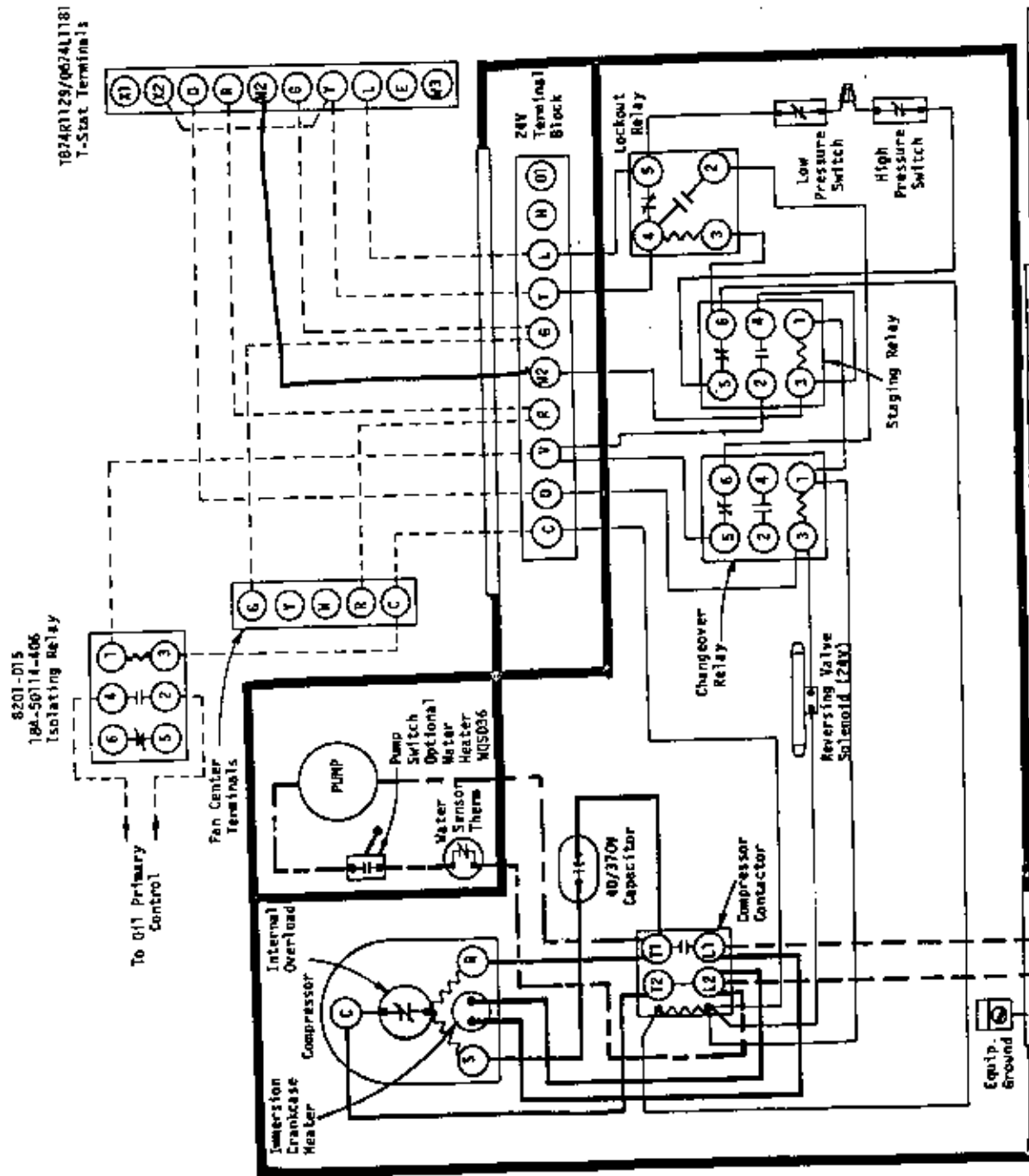

1874R1129/0674L1181
T-Stat Terminals

3201-D15
184-50114-406
Isolating Relay

To Oil Primary Control

Pan Center Terminals

MODELS
WQ336, WQ336
WATER SOURCE HEAT PUMP

Factory Wiring
Field Wiring
Optional Factory Wiring
Optional Field Wiring

Low Voltage
High Voltage

USE COPPER
WIRE ONLY

230/208-60-1

Equip. Ground

Replace.

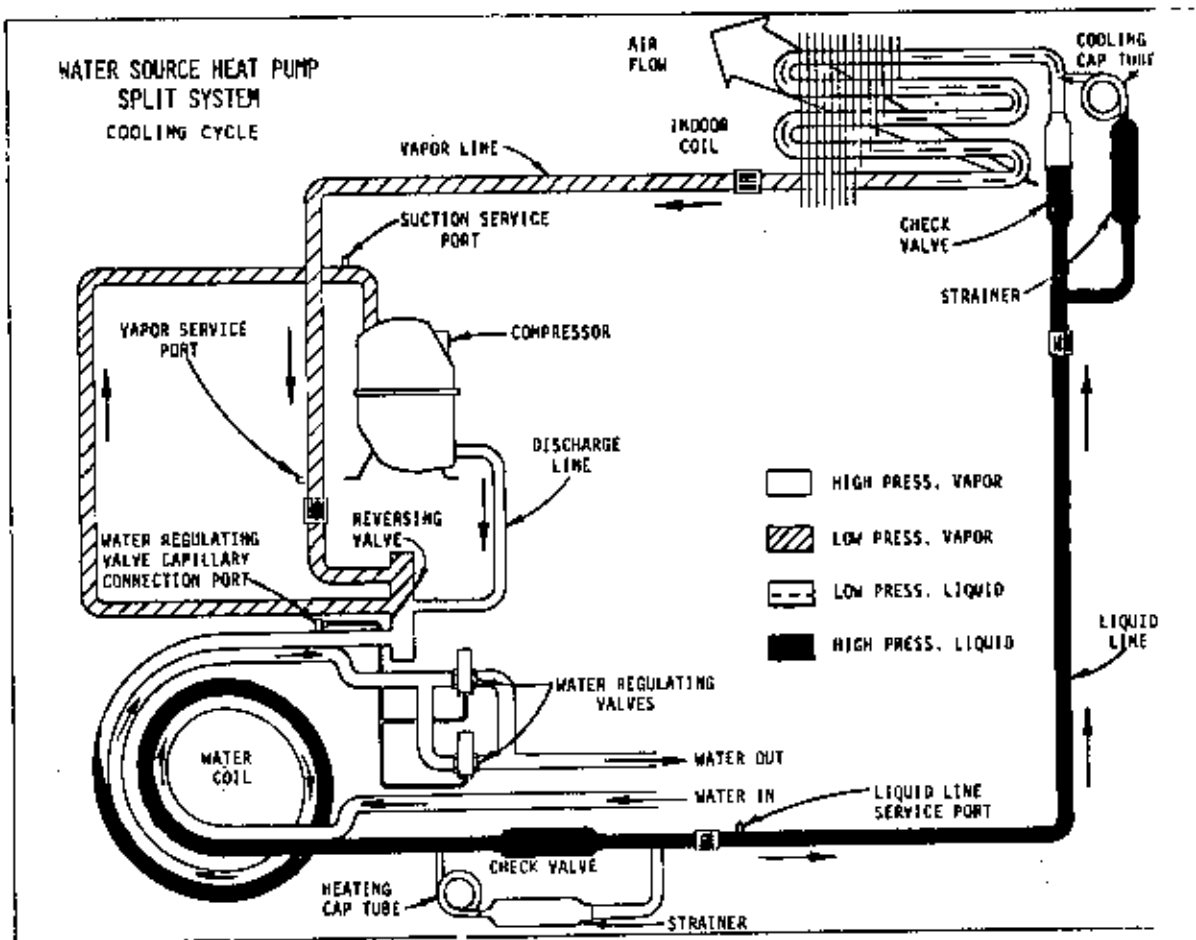
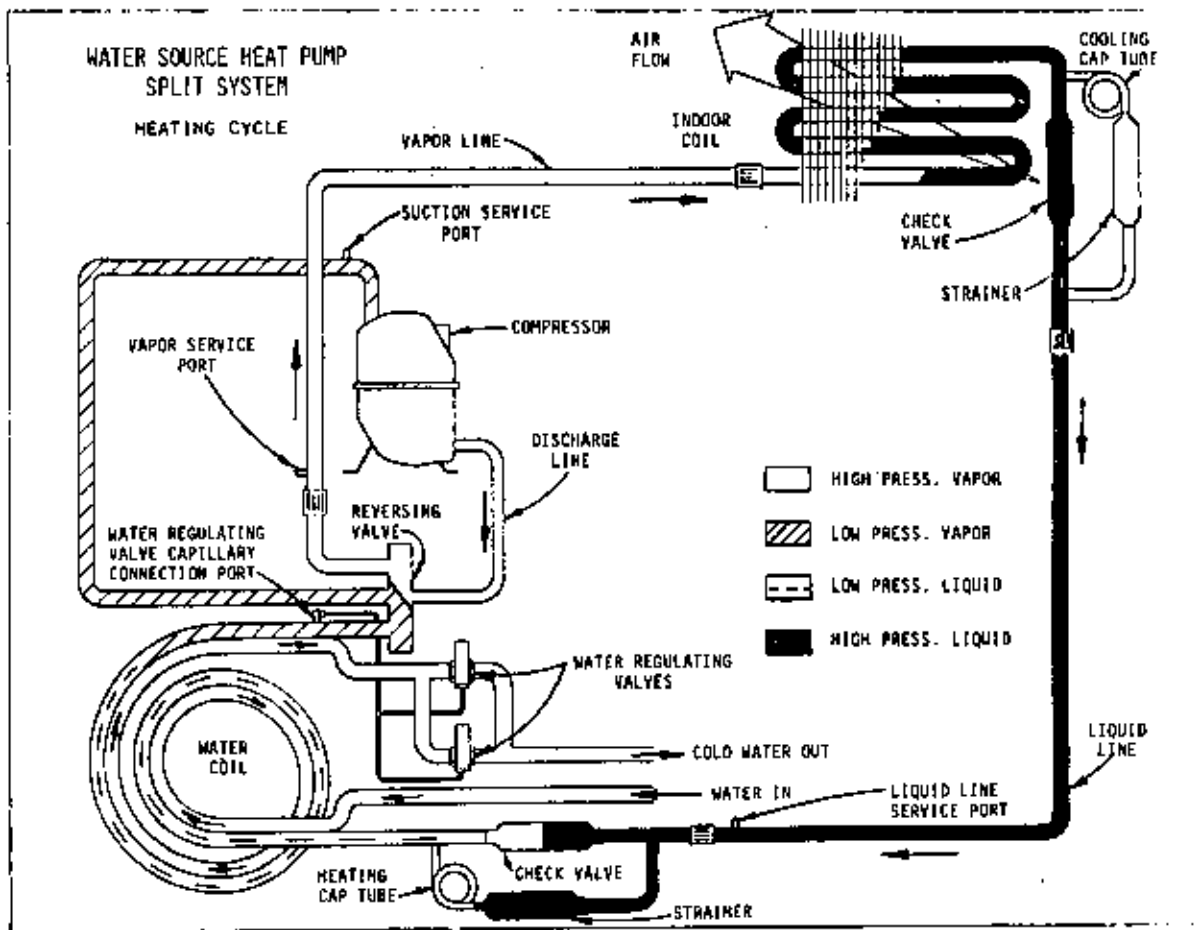



PERFORMANCE CHECK
WATER SOURCE HEAT PUMPS

INSTALLER PLEASE FILL OUT AND
RETAIN WITH UNIT

DATE OF INSTALLATION _____ MODEL NO(S). _____ SERIAL NO(S). _____

ITEM	COOLING	HEATING	JOB NUMBER
1. HEAD PRESSURE			NAME OF INSTALLER
2. SUCTION PRESSURE			NAME OF OWNER
3. WATER TEMP. (IN)			ADDRESS
4. WATER TEMP. (OUT)			CITY STATE
5. WATER PRESSURE (IN)			
6. WATER PRESSURE (OUT)			FIELD COMMENTS:
7. WATER FLOW (GPM)			
8. AMPERES (BLOWER)			
9. AMPERES (COMPRESSOR)			
10. LINE VOLTAGE (COMPRESSOR RUNNING)			
11. AIR TEMP. (IN) D.B.			
W.B.			
12. AIR TEMP. (OUT) D.B.			
W.B.			
13. DESUPERHEATER H ₂ O TEMP. (IN)			
14. DESUPERHEATER H ₂ O TEMP. (OUT)			

*This PERFORMANCE CHECK SHEET should be
filled out by installer and retained with unit.*

Bard Manufacturing Company
P.O. Box 807
Bryan, Ohio 43506

Print
048