

**MODELS**

**P48A4, P60A4**

**PACKAGED AIR CONDITIONER**

**INSTALLATION INSTRUCTIONS**

**FOR RESIDENTIAL AND COMMERCIAL  
HEATING / COOLING APPLICATIONS**

NOMINAL CABINET DIMENSIONS (Inches)							DUCT OPENINGS (Inches)			
Model	A	B	C	H	J	K	Discharge		Return Air	
							D	E	F	G
P24A2	23 $\frac{1}{4}$	40	32	1 $\frac{1}{8}$	21 $\frac{1}{8}$	11	24	6	28	12
P36A4 P31A	24 $\frac{1}{4}$	48 $\frac{3}{16}$	38 $\frac{1}{8}$	$\frac{7}{8}$	26 $\frac{1}{8}$	17 $\frac{1}{4}$	33	6	33	14
P48A4 P60A4	31 $\frac{1}{4}$	50	42	1 $\frac{1}{8}$	22 $\frac{1}{8}$	16 $\frac{1}{4}$	38	10	38	16

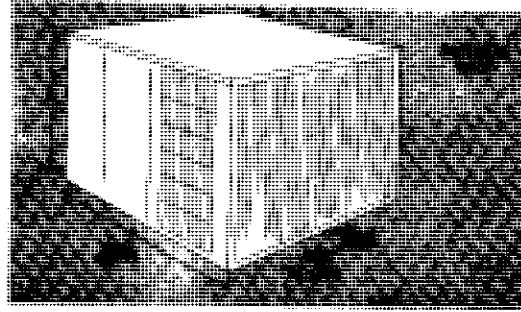
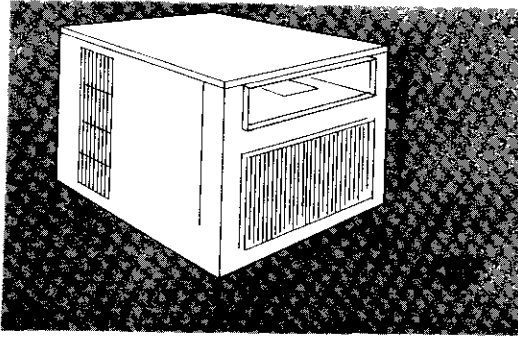

ELECTRICAL INFORMATION								WIRING INFORMATION**			
MODEL	Rated Volts & Ph	Operating Voltage Range	Heater** KW	Max Unit Amps	No. Field Power Circuits	Internal Fuses Ckt. A/B	Required $\Delta$ Overcurrent Protection	Min. Ckt. Ampacity Ckt. A/B	Field Power Wiring Ckt. A/B	Ground Wire Size Ckt. A/B	Wiring Diagram Number
P24A2	230/208-1	197-253	0	17.3	1		30	21	10	10	4000-110A -120A -130A
			5	24.8	1		35	31	8	10	
			10	45.6	1		60	57	4	10	
P31A	230/208-1	197-253	0	20.4	1		40	25	10	10	4048-110 -120A -130A -140A
			5	23.6	1		40	30	10	10	
			10	44.4	1	60/30	60	56	4	10	
			15	65.3	1		90	82	3	8	
P36A4	230/208	197-253	0	22.4	1		40	27	10	10	4001-110D -120D -130D -140F
			5	23.6	1		40	30	10	10	
			10	44.4	1	60/30	60	56	4	10	
			15	65.3	1		90	82	3	8	
P36A4	230/208-3	187-253	0	17.4	1		30	21	10	10	4001-210C -220C -230D -230D
			9	24.5	1		35	31	8	10	
			12	31.7	1		40	40	8	10	
			15	39	1		50	50	6	10	
P36A4	460-3	414-506	0	9.7	1		15	15	14	14	4001-310C -320E -320E -320E
			9	12.1	1		20	16	12	12	
			12	15.7	1		20	20	12	12	
			15	19.3	1		25	25	10	10	
P48A4	230/208-1	197-253	0	28	1		50	34	8	10	4002-110C -120C -130C -140E -150E
			5	28	1		50	34	8	10	
			10	44.8	1	60/30	60	56	4	10	
			15	65.7	1		90	83	3	8	
			20	86.5	1	60/60	110	108	1	6	
P48A4	230/208-3	187-253	0	20	1		35	24	10	10	4002-210C -220C -230D -230D -240E
			9	24.9	1		35	32	8	10	
			12	32.1	1		45	41	6	10	
			15	39.4	1		50	50	6	10	
			18	46.5	1		60	59	4	10	
P48A4	460-3	414-506	0	11	1		20	15	14	14	4002-310B -320B -320B -320B -330B
			9	12.4	1		20	16	12	12	
			12	16	1		20	20	12	12	
			15	19.6	1		25	25	10	10	
			18	23.3	1		30	30	10	10	
P60A4	230/208-1	197-253	0	36.5	1		60	45	6	10	4002-110C -120C -130C -140E -150E
			5	36.5	1		60	45	6	10	
			10	44.8	1	60/30	60	56	4	10	
			15	65.7	1		90	83	3	8	
			20	86.5	1	60/60	110	108	1	6	
P60A4	230/208-3	187-253	0	27.5	1		50	34	8	10	4002-210C -220C -230D -230D -240E
			9	27.5	1		50	34	8	10	
			12	32.1	1		50	41	6	10	
			15	39.4	1		50	50	6	10	
			18	46.6	1		60	59	4	10	
P60A4	460-3	414-506	0	13.8	1		25	17	12	12	4002-310B -320B -320B -320B -330B
			9	13.8	1		25	17	12	12	
			12	16	1		25	20	12	12	
			15	19.6	1		25	25	10	10	
			18	23.3	1		30	30	10	10	

\*Electric heaters are nominal KW @ 240V or 480V.  
 \*\*Based on 60°C copper wire. Other wiring materials must be rated for marked "minimum circuit ampacity" or greater. Not all models approved for aluminum wire.

$\Delta$  Time delay fuses or "HACR Type" circuit breakers must be used for 60 and smaller sizes. Standard fuses or circuit breakers are suitable for sizes 70 and larger.

# APPLICATION AND INSTALLATION INSTRUCTIONS FOR SINGLE PACKAGE AIR CONDITIONERS

## IMPORTANT

The equipment covered in this manual is to be installed by trained, experienced service and installation technicians. Any heat pump is more critical of proper operating charge and an adequate duct system than a straight air conditioning unit. All duct work, supply and return, must be properly sized for the design air flow requirement of the equipment. NESCA is an excellent guide to proper sizing. All duct work or portions thereof not in the conditioned space should be properly insulated in order to both conserve energy and prevent condensation or moisture damage.

## SHIPPING DAMAGE

Upon receipt of equipment, the carton should be checked for external signs of shipping damage. If damage is found, the receiving party must contact the last carrier immediately, preferably in writing, requesting inspection by the carrier's agent.

## GENERAL

The refrigerant system is completely assembled and charged. All internal wiring is complete.

The unit is designed for use with or without duct work. Flanges are provided for attaching the supply and return ducts.

These instructions explain the recommended method to install the air cooled self-contained unit and the electrical wiring connections to the unit.

These instructions and any instructions packaged with any separate equipment required to make up the entire air conditioning system should be carefully read before beginning the installation. Note particularly "Starting Procedure" and any tags and/or labels attached to the equipment.

While these instructions are intended as a general recommended guide, they do not supersede any national and/or local codes in any way. Authorities having jurisdiction should be consulted before the installation is made.

## INSTALLATION

Size of unit for a proposed installation should be based on heat loss calculation made according to methods of National Warm Air Heating and Air Conditioning Association. The air duct should be installed in accordance with the Standards of the National Fire Protection Association for the Installation of Air Conditioning and Ventilating Systems of Other Than Residence Type, NFPA No. 90A, and Residence Type Warm Air Heating and Air Conditioning Systems, NFPA No. 90B. Where local regulations are at a variance with instructions, installer should adhere to local codes.

## LOCATION

The unit must be located outside, or in a well ventilated area. It must not be in the space being heated or cooled. A sound absorbing material should be considered if the unit is to be installed in such a position or location that might cause transmission of sound or vibration to the living area or adjacent buildings.

## TYPICAL INSTALLATIONS

1. Roof-Mounted - The unit is mounted on a sturdy base on the roof of the building. Return air to the unit is brought through a single return grille (grilles with built-in filters are best, since they enable easy access for filter changing). Return air ducts are attached to the lower section of the front panel. Supply air is brought from the unit to attic duct work or to a furred down hall. Supply air duct is attached to the top of the front panel. CAUTION: All outdoor duct work must be thoroughly insulated and weatherproofed. All attic duct work must be thoroughly insulated. Two inch thick insulation with suitable vapor barrier is recommended for both outdoor and attic runs. In roof-top installation, as in all installations, the heat pump must be level from side to side. However, the unit should have a pitch along the length to assure complete external drainage of precipitation and of defrost condensate.
2. Crawl Space - Duct work installed in crawl space must be well insulated and provided with a vapor barrier. In addition, the crawl space must be thoroughly ventilated and provided with a good vapor barrier as a ground cover. It is most desirable to install the unit outdoors, rather than inside the crawl space, so that it will be readily accessible for service. In addition, it is necessary to dispose of the condensate from the outdoor coil on the heating cycle, and this is virtually impossible with the unit installed inside the crawl space.
3. Slab Mounted at Ground Level - This type installation is ideal for homes with slab floor construction, where a roof-mounted unit is not desired. The supply and return duct work can be run through a furred closet space.
4. Thru-The-Wall - This type installation requires a suitable framework to be fabricated, capable of withstanding the unit weight. Normally the unit will be installed so as to minimize supply and return duct work.
5. Other Installations - Many other installations are possible with the packaged air conditioner. No matter what the installation, always consider the following facts:
  - a. Insure that the discharge air is not obstructed in any way so as to cause operation difficulties.
  - b. The indoor coil drain pan is equipped with a coupling that must be piped through a condensate drain trap to a suitable drain.
  - c. Always mount the unit in such a position that it may be easily reached for servicing and maintenance.
  - d. Insure that the unit is clear so that proper air flow over the outdoor coil will be maintained.

INDOOR BLOWER PERFORMANCE CFM -- DRY COIL WITH FILTER			
E. S. P. In. H <sub>2</sub> O	MODELS		
	P24A2	P31A P36A4	P48A4 P60A4
.0	990	1420	1870
.10	889	1370	1830
.20	823	1320	1780
.30	747	1270	1720
.40	671	1200	1640
.50	608	1130	1565

**WIRING - MAIN POWER**

Refer to the unit rating plate for wire sizing information and maximum fuse or "HACR Type" circuit breaker size. Each outdoor unit is marked with a "Minimum Circuit Ampacity." This means that the field wiring used must be sized to carry that amount of current. Depending on the installed Kw of electric heat, there may be two field power circuits required. If this is the case, the unit serial plate will so indicate. Some models are suitable only for connection with copper wire, while others can be wired with either copper or aluminum wire. Each unit and/or wiring diagram will be marked "Use Copper Conductors Only" or "Use Copper or Aluminum Conductors." These instructions **MUST BE** adhered to. Refer to the National Electrical Code for complete current carrying capacity data on the various insulation grades of wiring material.

The electrical data lists fuse and wire sizes (60°F copper) for all models, including the most commonly used heater sizes. Also shown are the number of field power circuits required for the various models with heaters.

The unit rating plate lists a "Maximum Time Delay Fuse" or "HACR Type" circuit breaker that is to be used with the equipment. The correct size must be used for proper circuit protection and also to assure that there will be no nuisance tripping due to the momentary high starting current of the compressor motor.

**PRESSURE SERVICE PORTS**

High and low pressure service ports are installed on all units so that the system operating pressures can be observed. Pressure curves can be found later in the manual covering all models on both cooling and heating cycles. It is imperative to match the correct pressure curve to the unit by model number.

**AIR FILTERS**

Air filters for the return air side of the system are not provided as part of the basic piece of equipment because of the various types of application for these models, and must be field supplied and installed as part of the final installation.

Prior thought should be given to return air location and placement of the air filter(s). The air filter(s) must be of adequate size and readily accessible to the operator of the equipment. Filters must be adequate in size and properly maintained for proper operation. If this is not done, excessive energy use, poor performance, and multiple service problems will result. **IT IS IMPOSSIBLE TO OVERSIZE AIR FILTERS.** Generous sizing will result in cleaner air and coils, as well as lower operating costs and extend the time between required changes. The following table shows minimum filter areas and recommended filter sizes. Actual filter sizes can vary with the installation due to single or multiple returns utilizing a filter/grille arrangement or being placed immediately ahead of the indoor coil face in the return air duct.

MODEL	MINIMUM FILTER AREAS	RECOMMENDED SIZE
P24A2	336 sq.in. (2.34 sq.ft)	12x30-5/8x1
P31A, P36A4	462 sq.in. (3.21 sq.ft)	15x30-5/8x1
P48A4, P60A4	608 sq.in. (4.62 sq.ft)	(2)16x20x1

NOTE: If Roof Hood Accessory is to be used, information on air filters may be found under that heading in this manual. Air filters are supplied as part of that package.

MODEL	RATED AIRFLOW	95°F O.D. Temp.	82°F O.D. Temp.
P24A2	900	49 - 51	61 - 63
P31A	1150	58 - 60	62 - 64
P36A4	1275	49 - 51	52 - 54
P48A4	1700	52 - 54	61 - 63
P60A4	1700	50 - 52	60 - 62

**CRANKCASE HEATERS**

All units are provided with some form of compressor crankcase heat. Some single phase units utilize the compressor motor start winding in series with a portion of the run capacitor to generate heat within the compressor shell to prevent liquid refrigerant migration.

Some three phase units utilize a wraparound type of crankcase heater that warms the compressor oil from the outside.

Some single and three phase models have an insertion well-type heater located in the lower section of the compressor housing. This is a self-regulating type heater that draws only enough power to maintain the compressor at a safe temperature.

Some form of crankcase heat is essential to prevent liquid refrigerant from migrating to the compressor, causing oil pump out on compressor start-up and possible valve failure due to compressing a liquid.

Refer to unit wiring diagram to find exact type of crankcase heater used.

The following decal is affixed to all outdoor units detailing start-up procedure. This is very important. Please read carefully.

**IMPORTANT**

THESE PROCEDURES MUST BE FOLLOWED AT INITIAL START-UP AND AT ANY TIME POWER HAS BEEN REMOVED FOR 12 HOURS OR LONGER.

TO PREVENT COMPRESSOR DAMAGE WHICH MAY RESULT FROM THE PRESENCE OF LIQUID REFRIGERANT IN THE COMPRESSOR CRANKCASE

1. MAKE CERTAIN THE ROOM THERMOSTAT IS IN THE "OFF" POSITION (THE COMPRESSOR IS NOT TO OPERATE).
2. APPLY POWER BY CLOSING THE SYSTEM DISCONNECT SWITCH THIS ENERGIZES THE COMPRESSOR HEATER WHICH EVAPORATES THE LIQUID REFRIGERANT IN THE CRANKCASE.
3. ALLOW 4 HOURS OR 60 MINUTES PER POUND OF REFRIGERANT IN THE SYSTEM AS NOTED ON THE UNIT RATING PLATE, WHICHEVER IS GREATER.
4. AFTER PROPERLY ELAPSED TIME THE THERMOSTAT MAY BE SET TO OPERATE THE COMPRESSOR.
5. EXCEPT AS REQUIRED FOR SAFETY WHILE SERVICING - **DO NOT OPEN SYSTEM DISCONNECT SWITCH.**

7961-061

**IMPORTANT INSTALLER NOTES:**

1. For improved start-up performance wash the indoor coil with a dishwasher detergent.

RATED CFM AND E.S.P. (WET COIL—COOLING)			
MODEL	RATED CFM	RATED E.S.P.	RECOMMENDED AIRFLOW RANGE
P24A2	900	.20	800 - 975
P31A	1150	.35	1025 - 1275
P36A4	1275	.15	1150 - 1400
P48A4	1700	.20	1520 - 1850
P60A4	1700	.20	1500 - 1850

Figure 1

SLAB MOUNTING AT GROUND LEVEL  
(Above 32°F Outside Temperature)

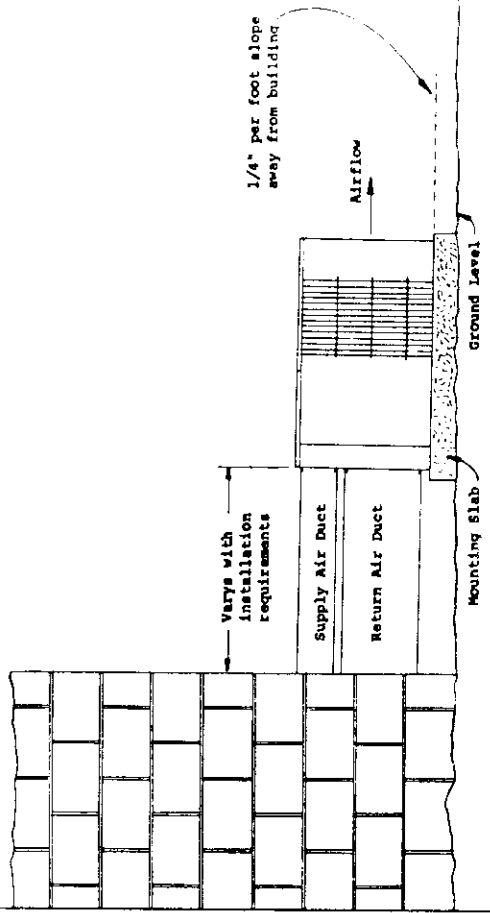

Figure 2

AIRFLOW AND SERVICE ACCESS CLEARANCES

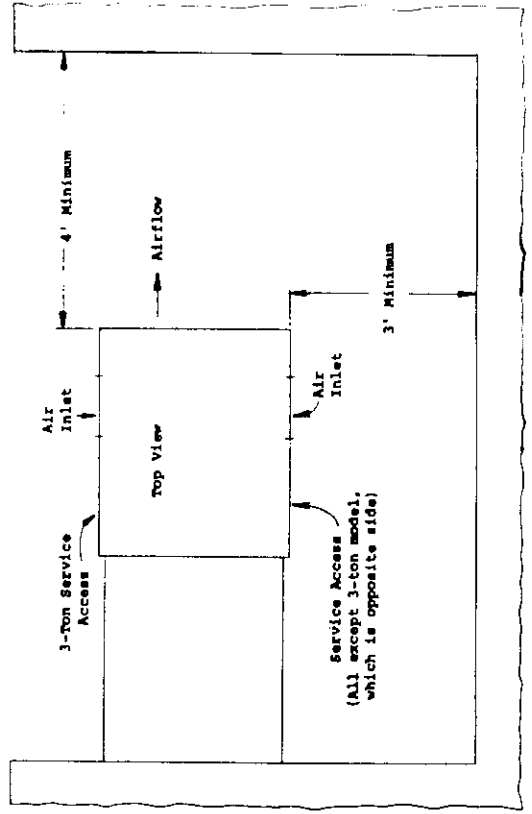

Figure 3

ROOFTOP APPLICATION  
(May also be required for ground level installations)

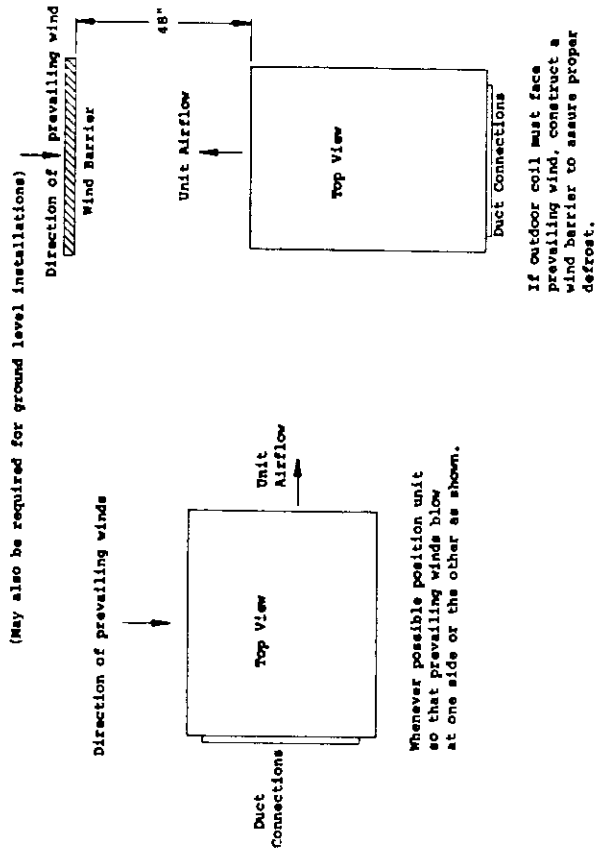
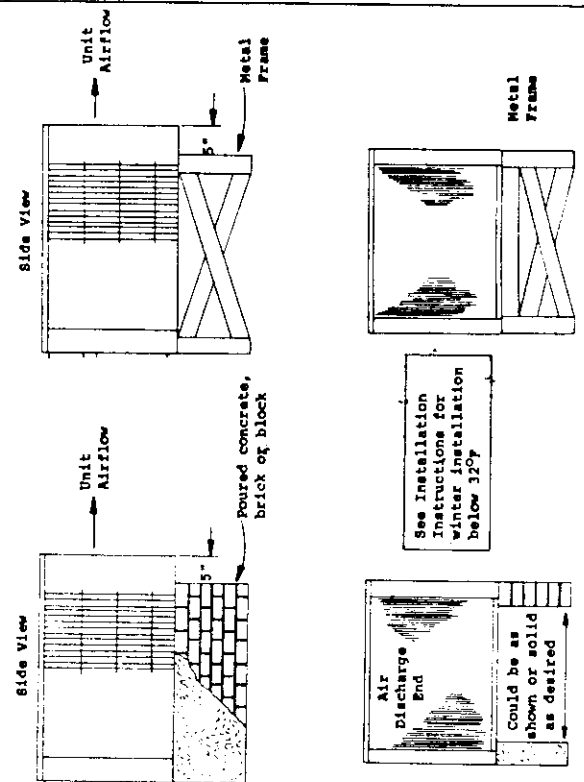
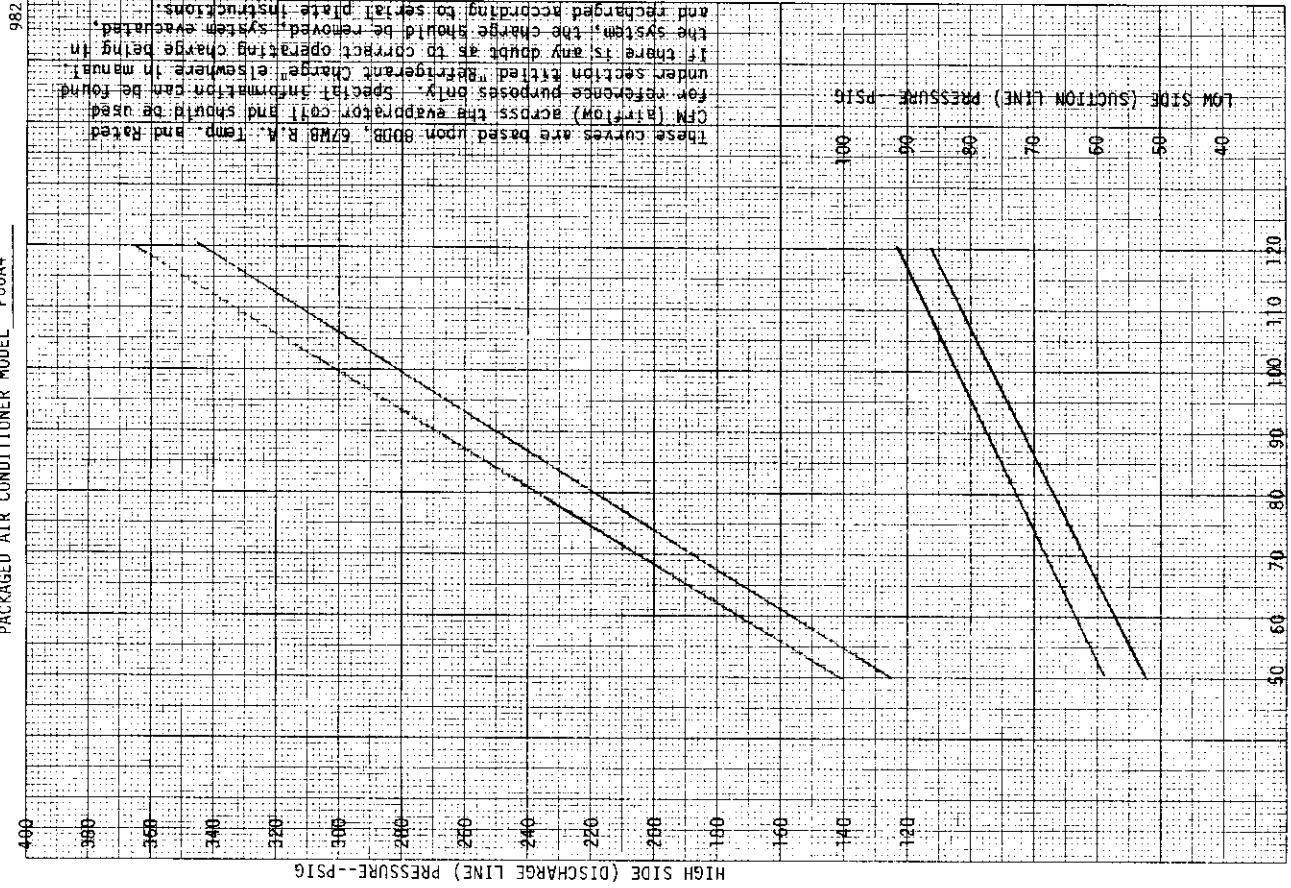

Figure 4

ELEVATED MOUNTING PLATFORMS



PACKAGED AIR CONDITIONER MODEL P50A4



PACKAGED AIR CONDITIONER MODEL P48A4

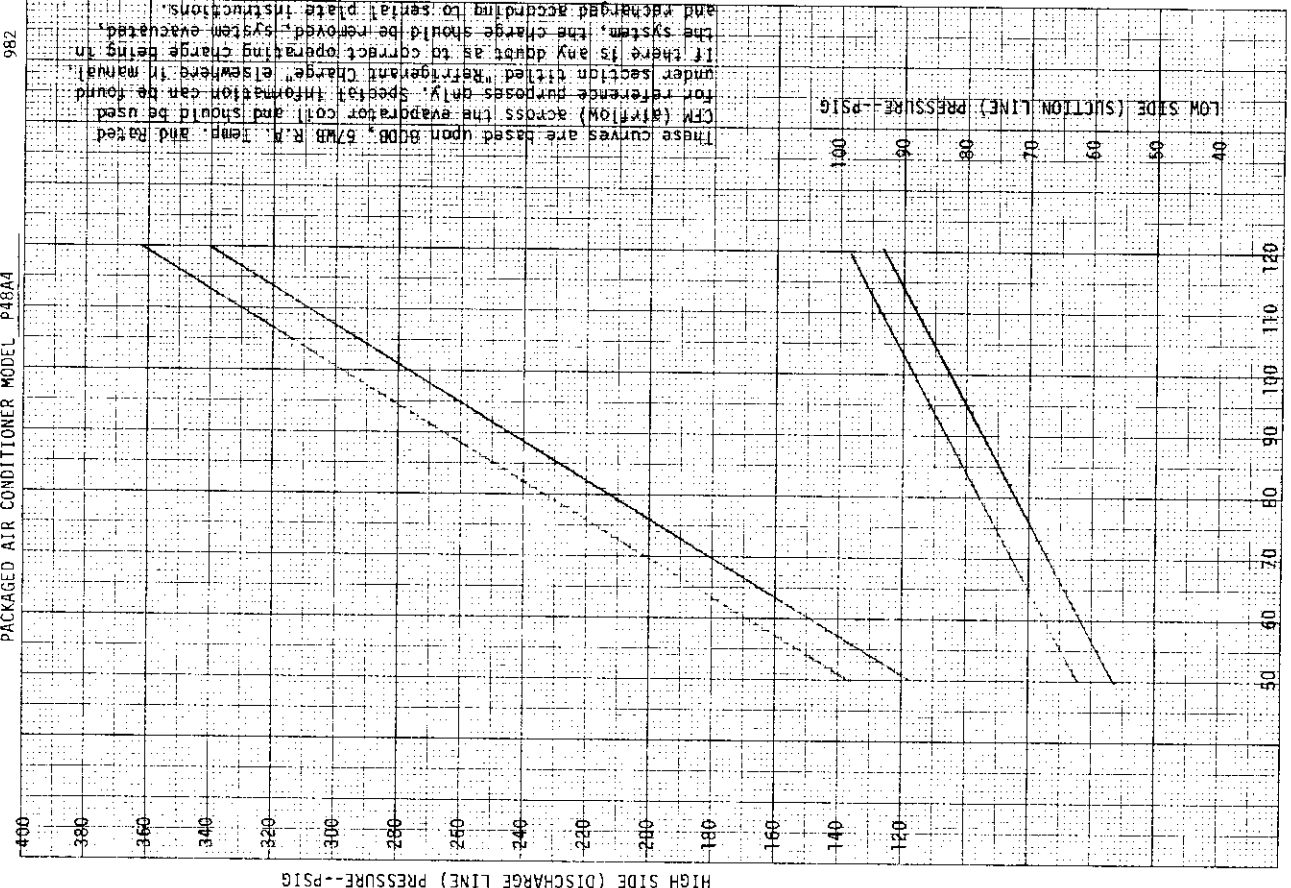

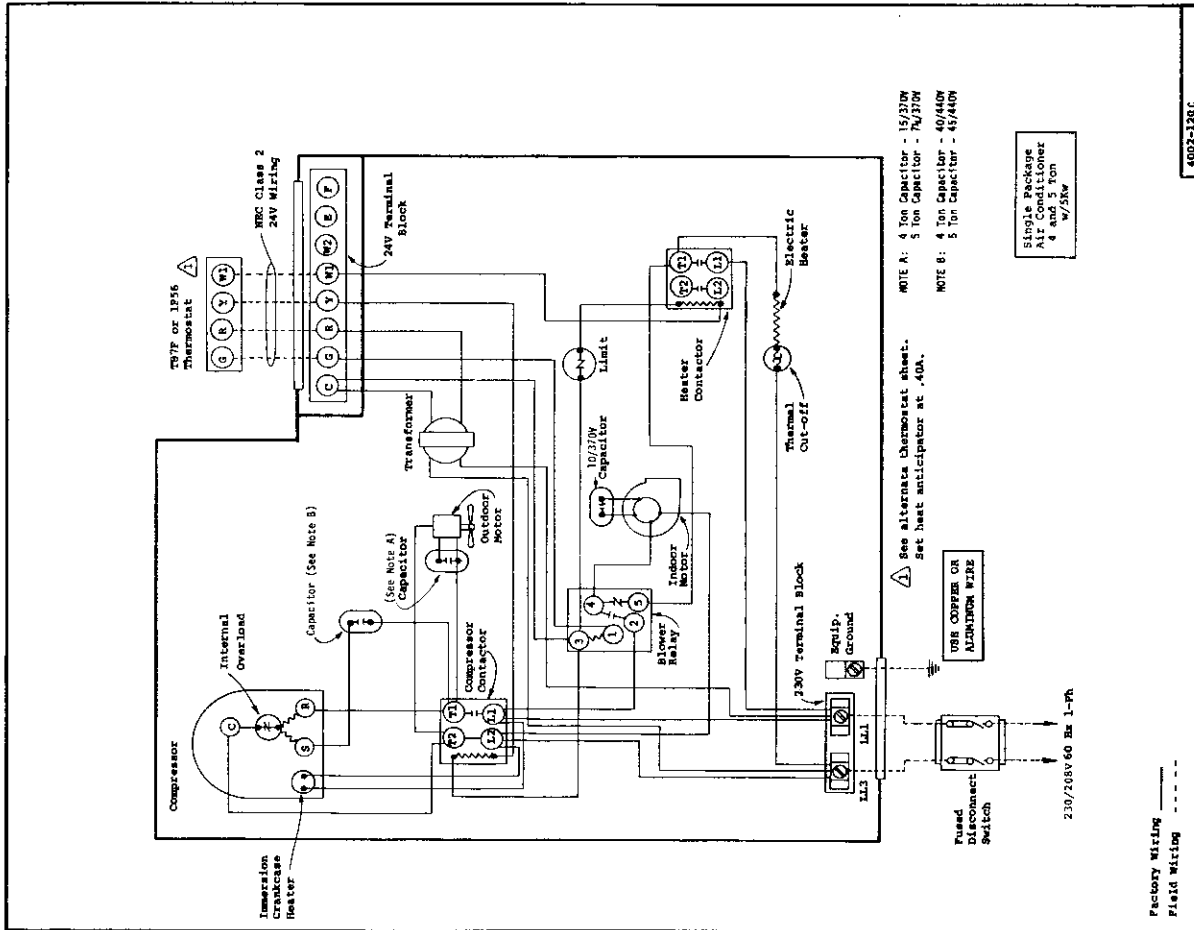
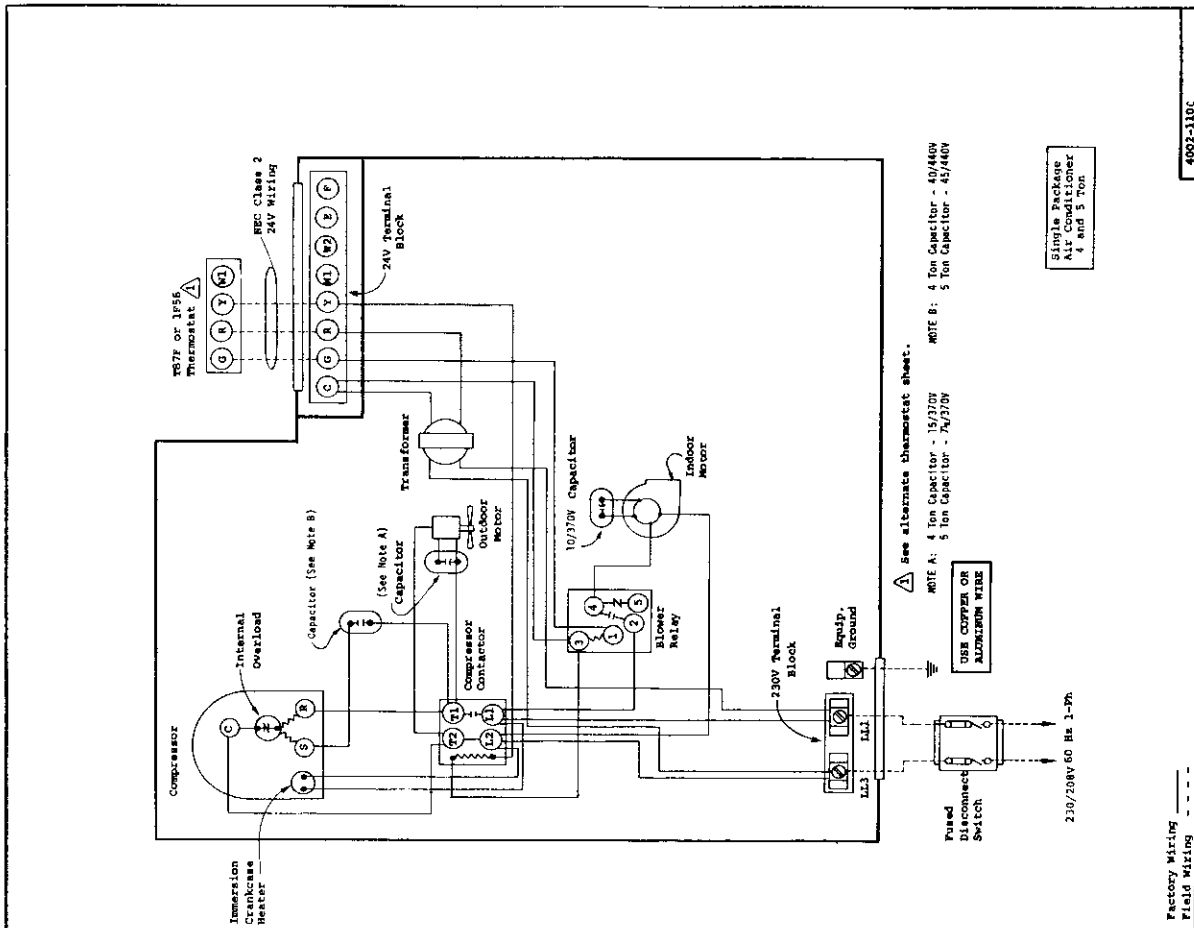

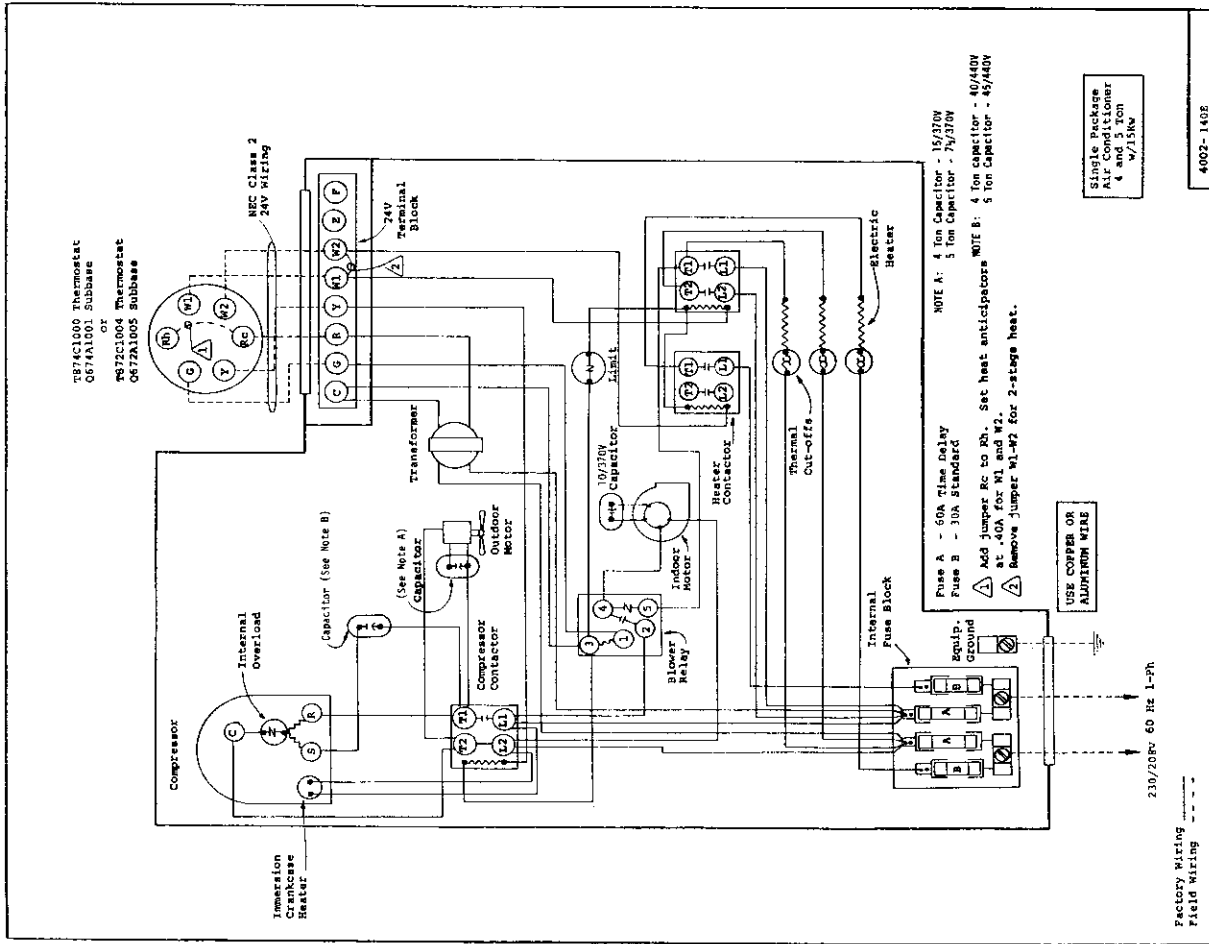
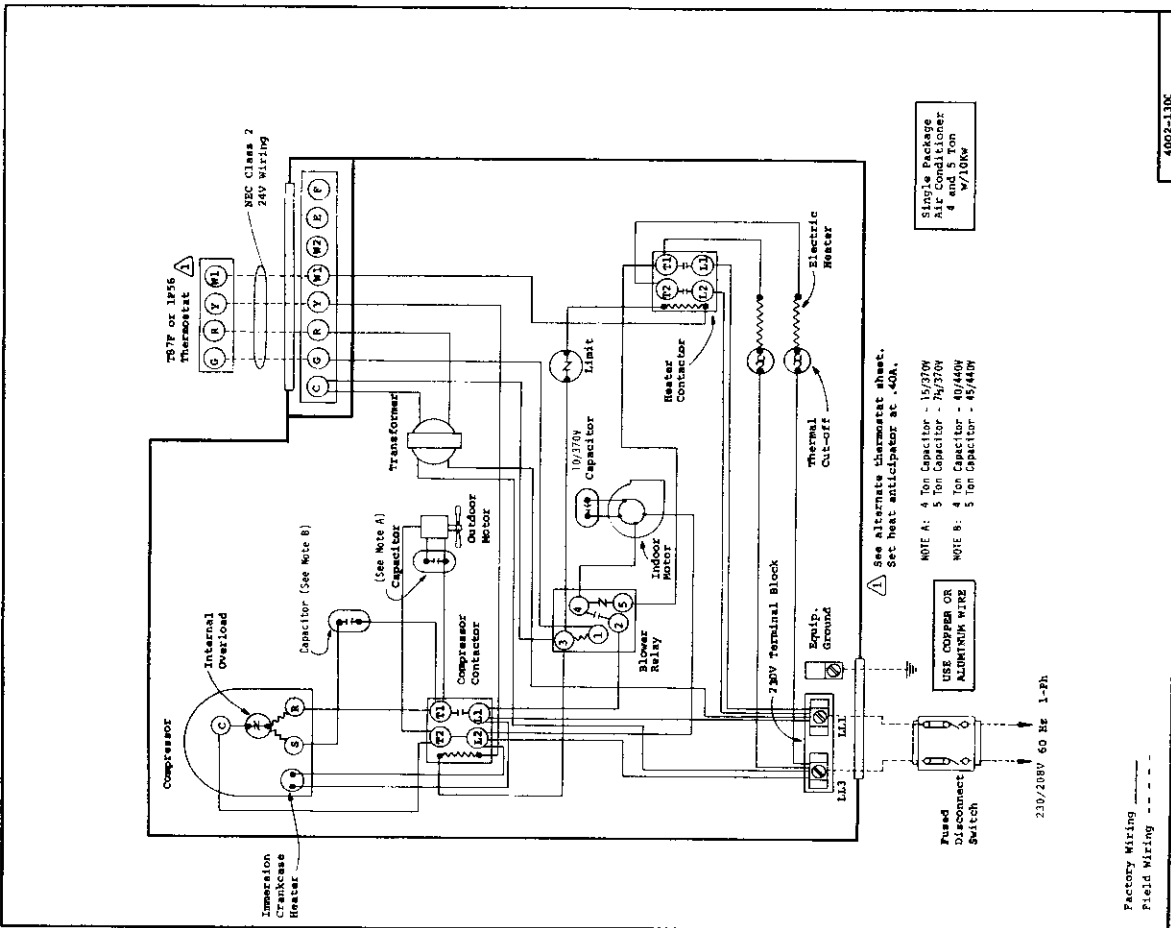



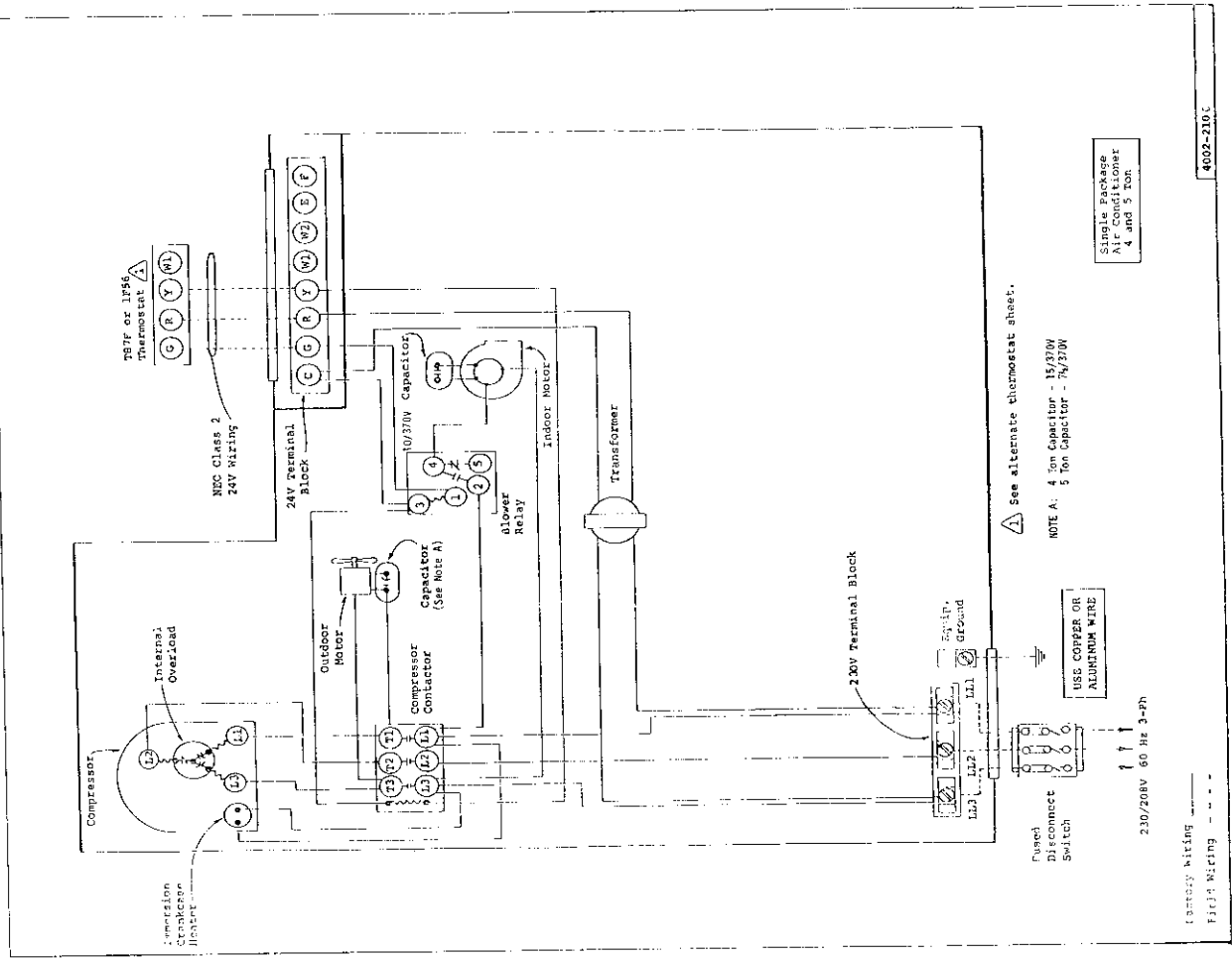
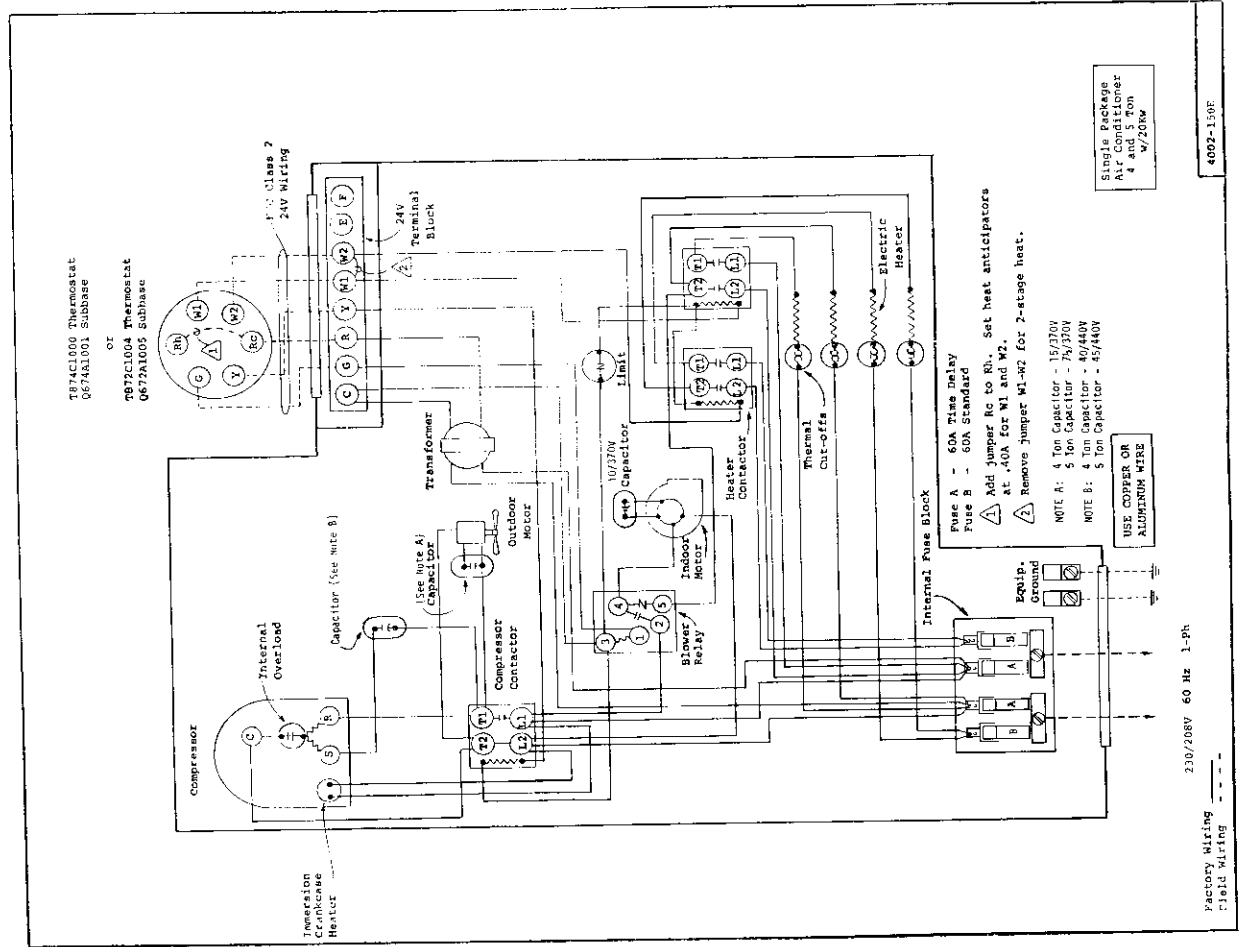

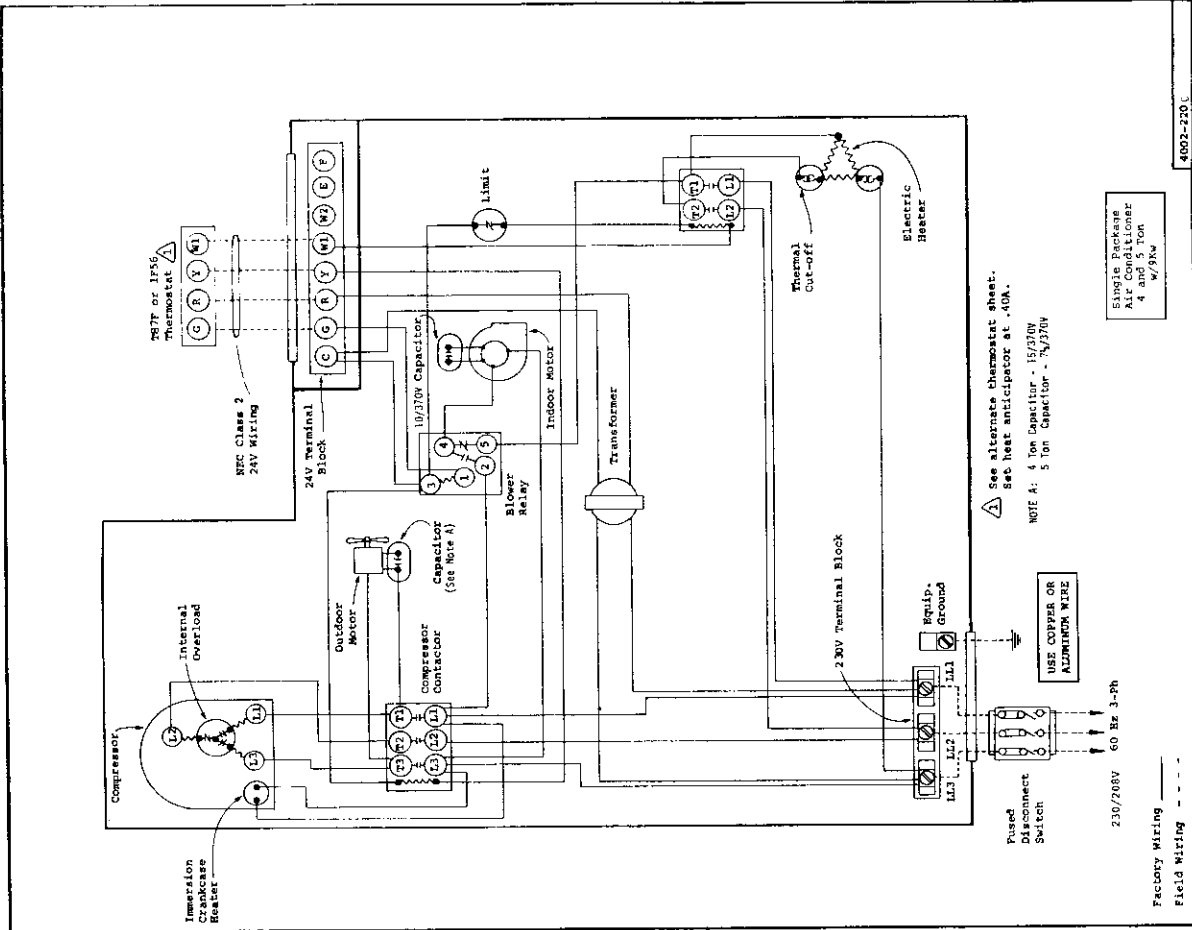

4002-220C

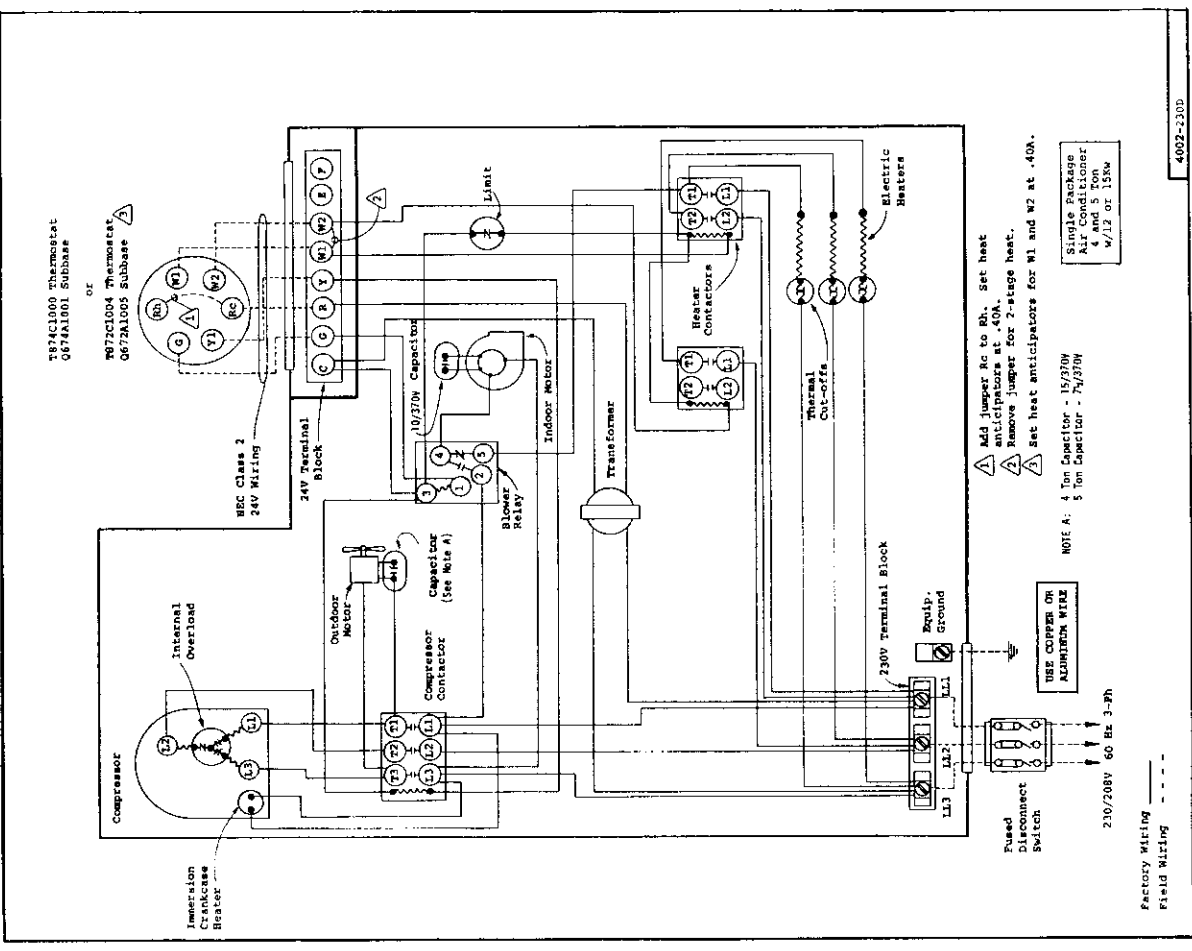

4002-230D

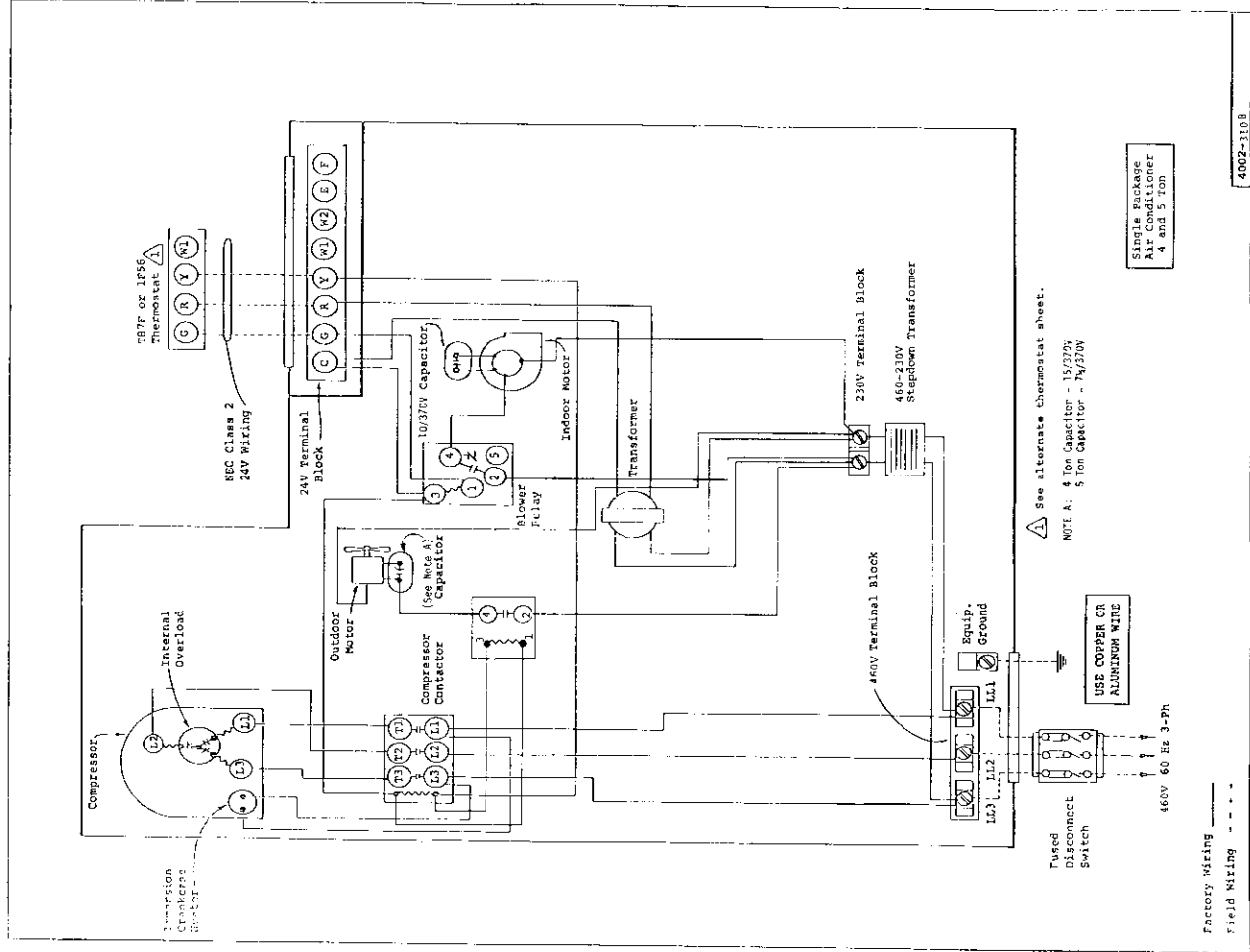
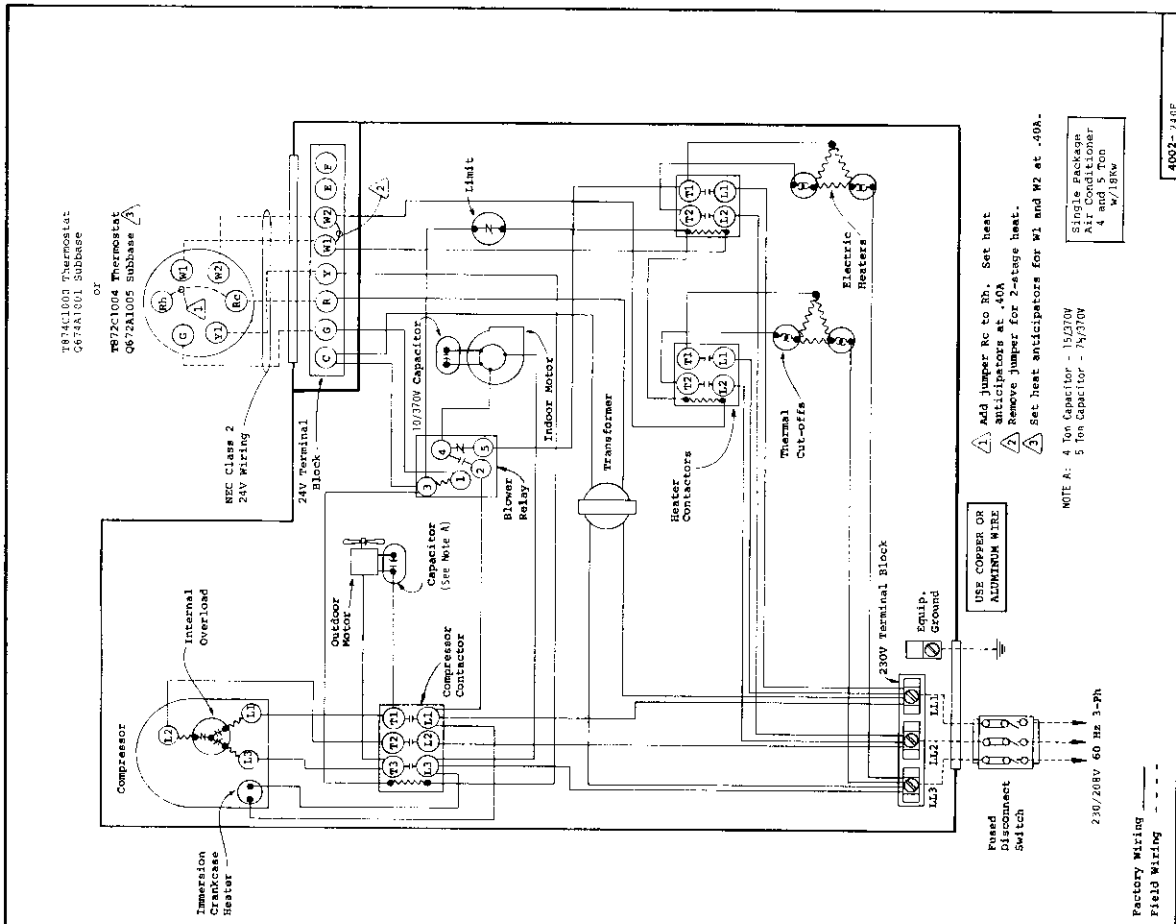

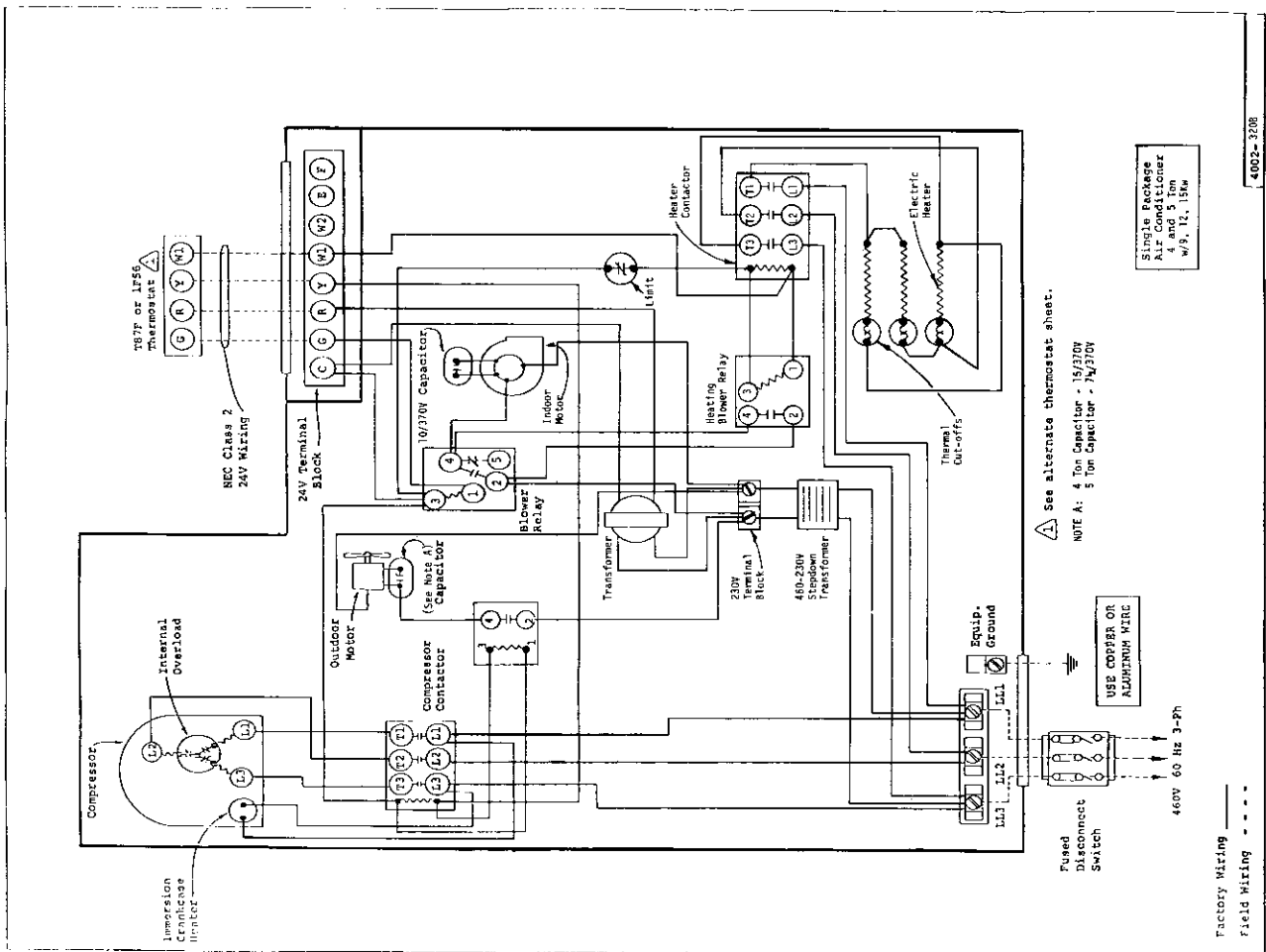

4002-3208

PARTS LIST  
SINGLE PACKAGE AIR CONDITIONERS

Effective 4/15/81  
Supersedes 1/29/81

PART NO.	DESCRIPTION	P48A4	P48A4-3	P60A4	P60A4-3	P48A4-3 460V	P60A4-3 460V
* 5152-015	Blower Housing 10-10 Blower Wheel DD10-10A	x	x	x	x	x	x
8552-030	Capacitor 40/440V	x					
8552-005	Capacitor 10/370V	x	x	x	x	x	x
8552-026	Capacitor 15/370V	x	x			x	
8552-031	Capacitor 45/440V			x			
8552-004	Capacitor 7-1/2/370V			x	x		x
5811-020	Capillary Tube - Cool	(2)	(2)			(2)	
5811-032	Capillary Tube - Cool			(2)	(2)		(2)
8000-063	Compressor CRK1-0325-PFV	x					
8000-064	Compressor CRK1-0325-TF5		x				
8000-065	Compressor CRK1-0325-TFD					x	
8000-027	Compressor AG122ET			x			
8000-031	Compressor AG122RT				x		
8000-048	Compressor AG122UT						x
5051-028	Condenser Coil	x	x	x	x	x	x
8401-007	Contactoer 1P25A	x					
8401-002	Contactoer 3P25A		x		x	x	x
8401-006	Contactoer - Heat 24V	x	x	x	x		
8401-016	Contactoer 1P35A			x			
5060-025	Evaporator Coil	x	x	x	x	x	x
** 5151-027	Fan Blade F12H9.5-2430 ccw	x	x			x	
** 5151-026	Fan Blade F12H9.5-2425 ccw			x	x		x
8614-017	Fuse Block	x		x			
8614-018	Fuse Block	x		x			
8614-022	Fuse 60A	x		x			
8614-006	Fuse 30A	x		x			
8614-007	Fuse 60A	x		x			
8604-048	Heat Strip 9Kw		x		x		
8604-046	Heat Strip 12Kw		x		x		
8604-047	Heat Strip 15Kw	x	x	x	x		
8604-044	Heat Strip 10Kw	x		x			
8604-050	Heat Strip 9Kw					x	x
8604-051	Heat Strip 12Kw					x	x
8604-052	Heat Strip 15Kw					x	x
8402-012	Limit Switch 130°	x	x	x	x	x	x
8106-015	Motor - Blower 1/2 hp	x	x	x	x	x	x
8105-021	Motor - Fan 1/3 hp	x	x			x	
8106-016	Motor - Fan 1/2 hp			x	x		x
5451-011	Motor Mtg. Parts	x	x	x	x	x	x
8200-004	Motor Mount - Fan	x	x	x	x	x	x
8200-003	Motor Mount - Blower	x	x	x	x	x	x
8201-009	Relay - Blower	x	x	x	x		
8201-008	Relay - Blower					x	x
5210-005	Strainer	x	x	x	x	x	x
8607-006	Terminal Board 24V	x	x	x	x	x	x
8607-001	Terminal Block 230V	x		x		x	x
8607-002	Terminal Block 230V		x		x	x	x
8402-025	Thermal Cut-off	x	x	x	x	x	x
8407-015	Transformer 55VA	x	x	x	x	x	x
8407-004	Transformer-Stepdown					x	x
7051-007	Wire Grille - Inlet	(2)	(2)	(2)	(2)	(2)	(2)
7051-005	Condenser Grille	x	x	x	x	x	x

Minimum Net Billing \$15.00. Supersedes all previous lists.

Subject to change without notice. F.O.B. Bryan, Ohio

\*Please order by model number.

\*\*Denotes change.