INSTALLATION INSTRUCTIONS

WALL-MOUNTED PACKAGED AIR CONDITIONER

Models:

H12AA-A

H24AA-A H24LA-A

H36AA-A H36LA-A

H42AA-A H42LA-A

H48AA-A H48LA-A

H60AA-A H60LA-A

H72AA-A H72LA-A



Climate Control Solutions

Bard Manufacturing Company, Inc.
Bryan, Ohio 43506
www.bardhvac.com

Manual: 2100-647B
Supersedes: 2100-647A
Date: 11-20-15

CONTENTS

Getting Other Information and Publications 3

Wall Mount General Information 4

Air Conditioner Wall Mount Model Nomenclature	4
Shipping Damage	4
General.....	4
Duct Work.....	5
Filters.....	5
Condensate Drain	5

Installation 6

Wall Mounting Information	6
Mounting the Unit	6
Wiring – Main Power	15
Wiring – Low Voltage Wiring.....	16
Dirty Filter Switch and Relay.....	16
Economizer Fail Time Delay Relay	16

Figures

Figure 1	H12 Unit Dimensions.....	7
Figure 2	H24-72 Unit Dimensions.....	8
Figure 3A	H12 Mounting Instructions	9
Figure 3B	H24 Mounting Instructions	10
Figure 3C	H36 Mounting Instructions	11
Figure 3D	H42-72 Mounting Instructions.....	12
Figure 4	Electric Heat Clearance	13
Figure 5	Wall Mounting Instructions	14
Figure 6	Wall Mounting Instructions	14
Figure 7	Common Wall Mounting Installations ...	15
Figure 8	Fan Blade Setting	20
Figure 9A	H12AA Wiring Diagram – Top	28
Figure 9B	H24,36*A Wiring Diagram – Top	29
Figure 9C	H42,48,60A Wiring Diagram – Top	30
Figure 9D	H72*A Wiring Diagram – Top	31
Figure 10	H***A Wiring Diagram – Bottom.....	32
Figure 11	H***A Low Voltage Diagram for Unit and MV Connections.....	33

Start Up 17

General.....	17
Topping Off System Charge.....	17
Safety Practices.....	17
Important Installer Note	17
High Pressure and Low Pressure Switches.....	18
Condenser Fan Operation	18
Service Hints.....	18
Sequence of Operation	18
Compressor Control Module	18
Pressure Service Ports.....	19

Service 20

Fan Blade Setting Dimensions	20
Removal of Fan Shroud	20
R410A Refrigerant Charge.....	20

Tables

Table 1	Sequence of Operation	19
Table 2	Fan Blade Dimension	20
Table 3	Cooling Pressure	21
Table 4A	Electrical Specifications H**A Series ...	22
Table 4B	Electrical Specifications H**L Series ...	23
Table 5	Recommended Airflow	24
Table 6	Indoor Blower Performance	24
Table 7	Max ESP of Operation Elec Heat Only ..	24
Table 8A	H12 Electric Heat	24
Table 8B	H24-72 Electric Heat.....	24
Table 9	Optional Accessories	25
Table 10	Vent and Control Options	25
Table 11	Unit Low Voltage Terminal Connection Chart – MV Series Controller	26
Table 12	Unit Low Voltage Terminal Connection Chart – Cooling/Heating Thermostat	27

GETTING OTHER INFORMATION AND PUBLICATIONS

These publications can help when installing the furnace. They can usually be found at the local library or purchased directly from the publisher. Be sure to consult the current edition of each standard.

National Electrical Code.....ANSI/NFPA 70

Standard for the InstallationANSI/NFPA 90A
of Air Conditioning and Ventilating Systems

Standard for Warm Air.....ANSI/NFPA 90B
Heating and Air Conditioning Systems

Load Calculation for ACCA Manual J
Residential Winter and Summer Air Conditioning

Duct Design for Residential ACCA Manual D
Winter and Summer Air Conditioning and Equipment
Selection

For more information, contact these publishers:

ACCA **Air Conditioning Contractors of America**
1712 New Hampshire Ave. N.W.
Washington, DC 20009
Telephone: (202) 483-9370
Fax: (202) 234-4721

ANSI **American National Standards Institute**
11 West Street, 13th Floor
New York, NY 10036
Telephone: (212) 642-4900
Fax: (212) 302-1286

ASHRAE **American Society of Heating, Refrigeration
and Air Conditioning Engineers, Inc.**
1791 Tullie Circle, N.E.
Atlanta, GA 30329-2305
Telephone: (404) 636-8400
Fax: (404) 321-5478

NFPA **National Fire Protection Association**
Batterymarch Park
P.O. Box 9101
Quincy, MA 02269-9901
Telephone: (800) 344-3555
Fax: (617) 984-7057

WALL MOUNT GENERAL INFORMATION

AIR CONDITIONER WALL MOUNT MODEL NOMENCLATURE

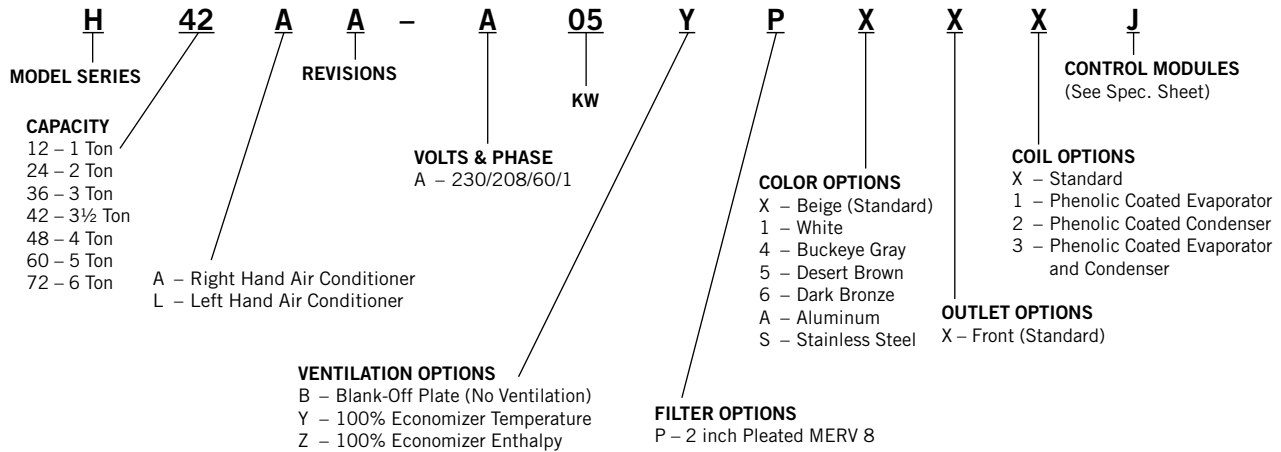

⚠ WARNING

Electrical shock hazard.

Have a properly trained individual perform these tasks.

Failure to do so could result in electric shock or death.

⚠ CAUTION

Cut hazard.

Wear gloves to avoid contact with sharp edges.

Failure to do so could result in personal injury.

SHIPPING DAMAGE

Upon receipt of equipment, the carton should be checked for external signs of shipping damage. If damage is found, the receiving party must contact the last carrier immediately, preferably in writing, requesting inspection by the carrier’s agent.

GENERAL

The equipment covered in this manual is to be installed by trained, experienced service and installation technicians.

The refrigerant system is completely assembled and charged. All internal wiring is complete.

The unit is designed for use with or without duct work. Flanges are provided for attaching the supply and return ducts.

These instructions explain the recommended method to install the air cooled self-contained unit and the electrical wiring connections to the unit.

These instructions and any instructions packaged with any separate equipment required to make up the entire air conditioning system should be carefully read before beginning the installation. Note particularly “Starting Procedure” and any tags and/or labels attached to the equipment.

While these instructions are intended as a general recommended guide, they do not supersede any national and/or local codes in any way. Authorities having jurisdiction should be consulted before the installation is made. See page 3 for information on codes and standards.

Size of unit for a proposed installation should be based on heat loss calculation made according to methods of Air Conditioning Contractors of America (ACCA). The air duct should be installed in accordance with the Standards of the National Fire Protection Association for the Installation of Air Conditioning and Ventilating Systems of Other Than Residence Type, NFPA No. 90A, and Residence Type Warm Air Heating and Air Conditioning Systems, NFPA No. 90B. Where local regulations are at a variance with instructions, installer should adhere to local codes.

DUCT WORK

All duct work, supply and return, must be properly sized for the design airflow requirement of the equipment. Air Conditioning Contractors of America (ACCA) is an excellent guide to proper sizing. All duct work or portions thereof not in the conditioned space should be properly insulated in order to both conserve energy and prevent condensation or moisture damage.

Refer to Table 5 for maximum static pressure available for duct design.

Design the duct work according to methods given by the Air Conditioning Contractors of America (ACCA). When duct runs through unheated spaces, it should be insulated with a minimum of one inch of insulation. Use insulation with a vapor barrier on the outside of the insulation. Flexible joints should be used to connect the duct work to the equipment in order to keep the noise transmission to a minimum.

For the H Model Series 36-72, a 1/4" clearance to combustible material for the first 3' of duct attached to the outlet air frame is required. See Wall Mounting Instructions and Figures 3A-D and Figure 4 for further details.

Ducts through the walls must be insulated and all joints taped or sealed to prevent air or moisture entering the wall cavity.

Some installations may not require any return air duct. A metallic return air grille is required with installations not requiring a return air duct. The spacing between louvers on the grille shall not be larger than 5/8".

Any grille that meets with 5/8" louver criteria may be used. It is recommended that Bard Return Air Grille Kit RG2W thru RG5W or RFG2W thru RFG5W be installed when no return duct is used. Contact distributor or factory for ordering information. If using a return air filter grille, filters must be of sufficient size to allow a maximum velocity of 400 fpm.

NOTE: *If no return air duct is used, applicable installation codes may limit this cabinet to installation only in a single story structure.*

FILTERS

A 2" pleated MERV 8 is standard with each unit. The filter slides into position making it easy to service. This filter can be serviced from the outside by removing the filter access panel.

CONDENSATE DRAIN

A plastic drain hose extends from the drain pan at the top of the unit down to the unit base. There are openings in the unit base for the drain hose to pass through. In the event the drain hose is connected to a drain system of some type, it must be an open or vented type system to assure proper drainage.

INSTALLATION

WALL MOUNTING INFORMATION

- Two holes for the supply and return air openings must be cut through the wall as shown in Figures 3A-D on pages 9-12.
- On wood frame walls, the wall construction must be strong and rigid enough to carry the weight of the unit without transmitting any unit vibration.
- Concrete block walls must be thoroughly inspected to insure that they are capable of carrying the weight of the installed unit.

MOUNTING THE UNIT

- These units are secured by wall mounting brackets which secure the unit to the outside wall surface at both sides. A bottom mounting bracket, attached to skid for shipping, is provided for ease of installation, but is not required.
- The unit itself is suitable for 0 clearance, but the supply air duct flange and the first 3' of supply air duct require a minimum of 1/4" clearance to combustible material for Model Series H36, H42, H48, H60 and H72. However, it is generally recommended that a 1" clearance is used for ease of installation and maintaining the required clearance to combustible material. See Figures 3A-D for details on opening sizes.

Minimum Clearances Required to Combustible Materials

MODELS	SUPPLY AIR DUCT FIRST 3'	CABINET
H12A H24A, H24L	0"	0"
H36A, H36L H42A, H42L H48A, H48L H60A, H60L H72A, H72L	1/4"	0"

WARNING

Failure to provide the 1/4" clearance between the supply duct and a combustible surface for the first 3' of duct can result in fire causing damage, injury or death.

Clearances Required for Service Access and Adequate Condenser Airflow

MODELS	LEFT SIDE	RIGHT SIDE	DISCHARGE SIDE
H12A, H24A, H36A	15"	20"	10'
H24L, H36L	20"	15"	10'
H42A, H48A, H60A, H72A	20"	20"	10'
H42L, H48L, H60L, H72L	20"	20"	10'

NOTE: For side-by-side installation of two H**A models there must be 20" between units. This can be reduced to 15" by using a H**L model (left side compressor and controls) for the left unit and H**A (right side compressor and controls) for right unit.

- Locate and mark lag bolt locations and bottom mounting bracket location (see Figures 3A-D).
- Mount bottom mounting bracket.
- Hook top rain flashing, attached to front-right corner of supply flange for shipping, under back bend of top.
- Position unit in opening and secure with fasteners sufficient for the application such as 5/16 lag bolts; use 7/8" diameter flat washers on the lag bolts.
- Secure rain flashing to wall and caulk across entire length of top (see Figures 3A-D).
- For additional mounting rigidity, the return air and supply air frames or collars can be drilled and screwed or welded to the structural wall itself (depending upon wall construction). Be sure to observe required clearance if combustible wall.
- On side-by-side installations, maintain a minimum of 20" clearance on right side to allow access to control panel and heat strips, and to allow proper airflow to the outdoor coil. Additional clearance may be required to meet local or national codes.
- Care should be taken to ensure that the recirculation and obstruction of condenser discharge air does not occur. Recirculation of condenser discharge air can be from either a single unit or multiple units. Any object such as shrubbery, a building or other large object can cause obstructions to the condenser discharge air. Recirculation or reduced airflow caused by obstructions will result in reduced capacity, possible unit pressure safety lockouts and reduced unit service life.

For units with blow through condensers, it is recommended there be a minimum distance of 10' between the front of the unit and any barrier or 20' between the fronts of two opposing (facing) units.

FIGURE 1
H12AA Unit Dimensions

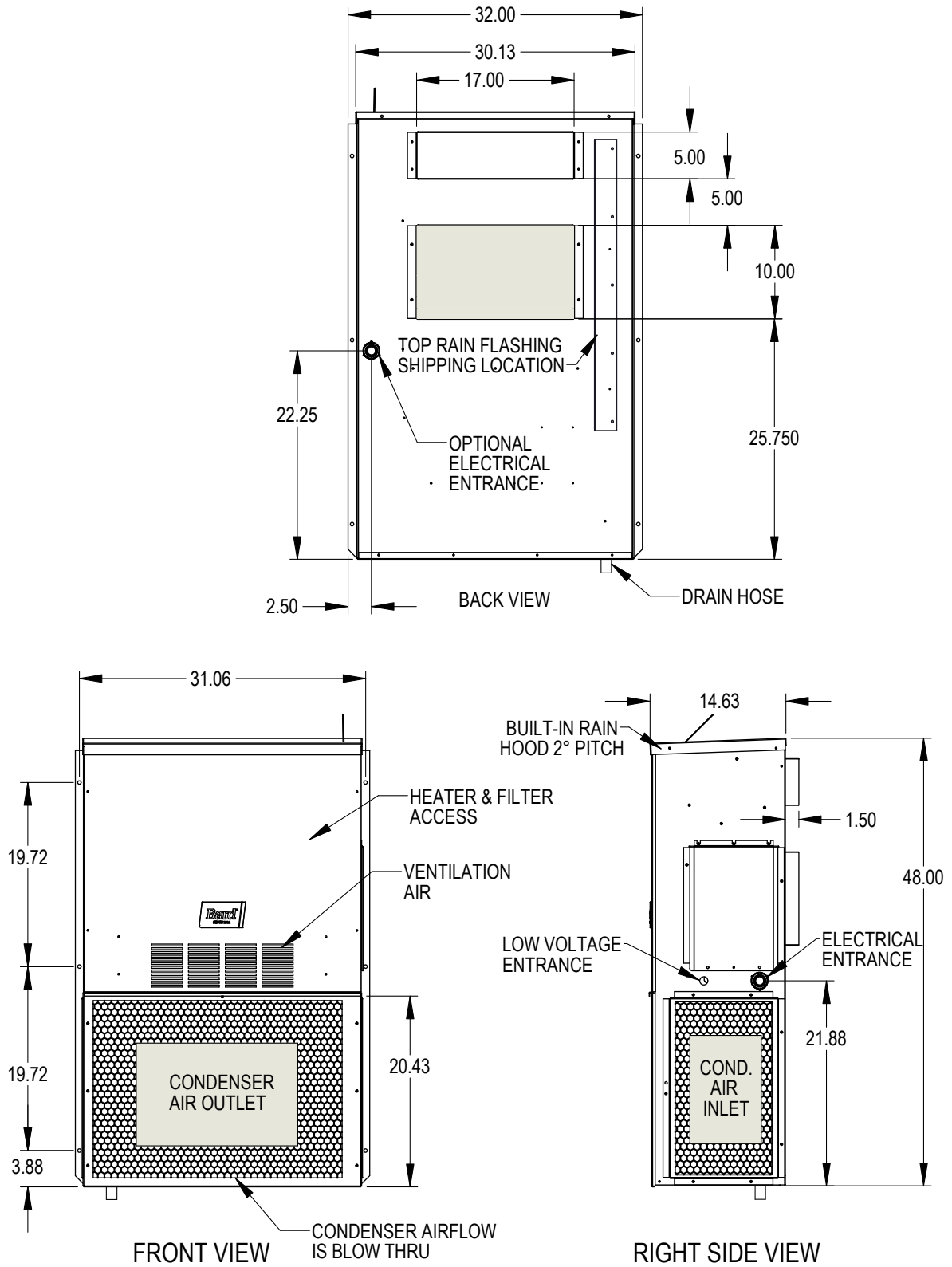

MIS-3599

NOTE: Maintain a minimum of 20" clearance on right side to allow access to control panel and allow proper airflow to outdoor condenser coil. Allow 15" on left side.

FIGURE 2

Dimensions of Basic Unit for Architectural and Installation Requirements (Nominal)

MODEL	WIDTH (W)	DEPTH (D)	HEIGHT (H)	SUPPLY		RETURN																
				A	B	C	B	E	F	G	I	J	K	L	M	N	O	P	Q	R	S	T
H24A, L	33.300	17.125	74.563	7.88	19.88	11.88	19.88	35.00	10.88	29.75	20.56	30.75	32.06	33.25	31.00	2.63	34.13	26.06	10.55	4.19	12.00	9.00
H36A, L	38.200	17.125	74.563	7.88	27.88	13.88	27.88	40.00	10.88	29.75	17.93	30.75	32.75	33.25	31.00	2.75	39.13	26.75	9.14	4.19	12.00	9.00
H42A, L	42.075	22.432	84.875	9.88	29.88	15.88	29.88	43.88	13.56	31.66	30.00	32.68	26.94	34.69	32.43	3.37	43.00	23.88	10.00	1.44	16.00	1.88
H60A, L	42.075	22.432	93.000	9.88	29.88	15.88	29.88	43.88	13.56	37.00	30.00	40.81	35.06	42.81	40.56	3.37	43.00	31.00	10.00	1.44	16.00	10.00

All dimensions are in inches. Dimensional drawings are not to scale.

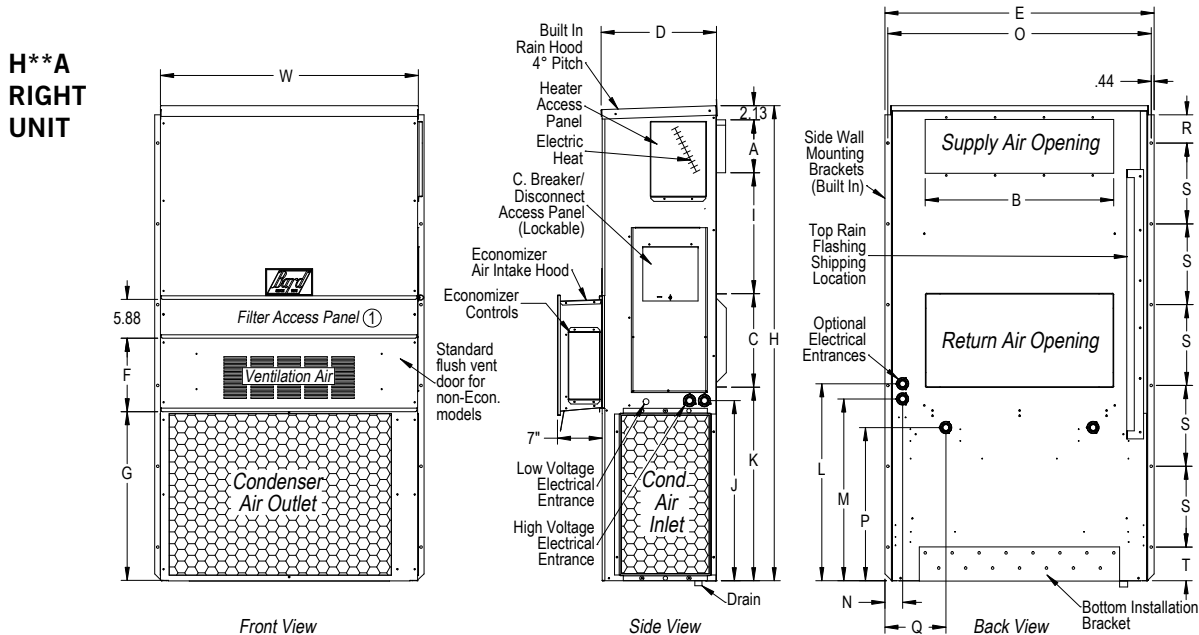

① Not used when EWM economizer is installed. Filter access is through the EWM hood.

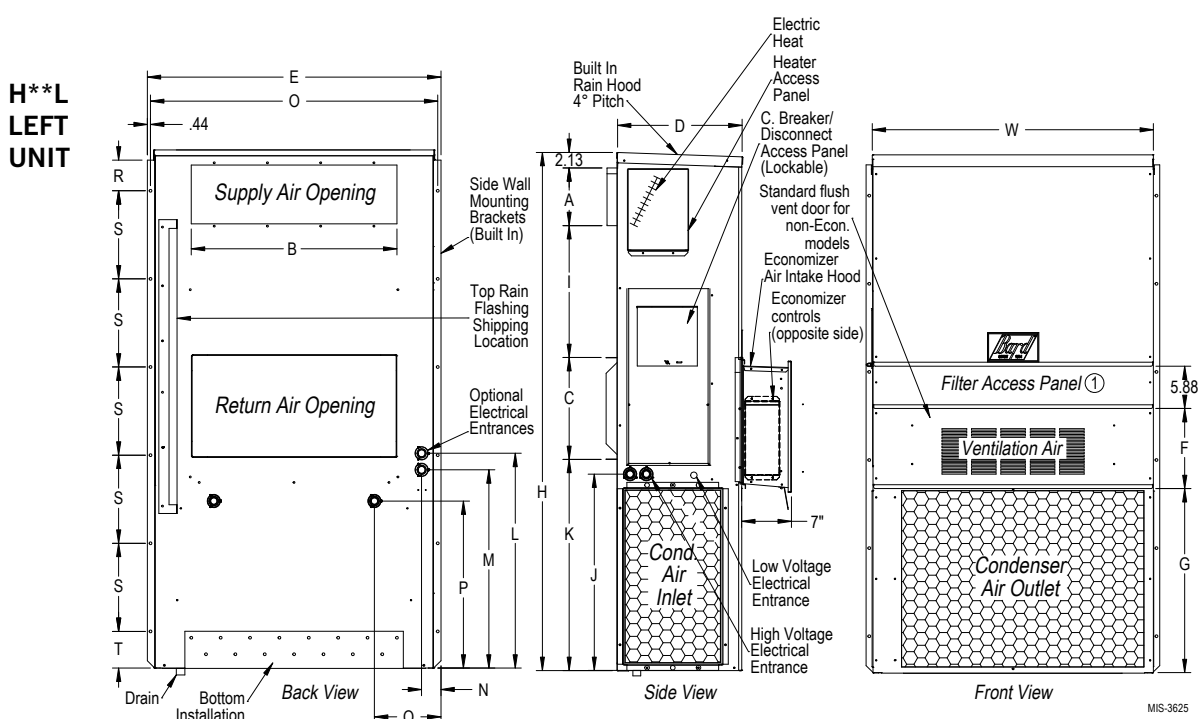

① Not used when EWM economizer is installed. Filter access is through the EWM hood.

FIGURE 3A
H12AA Mounting Instructions

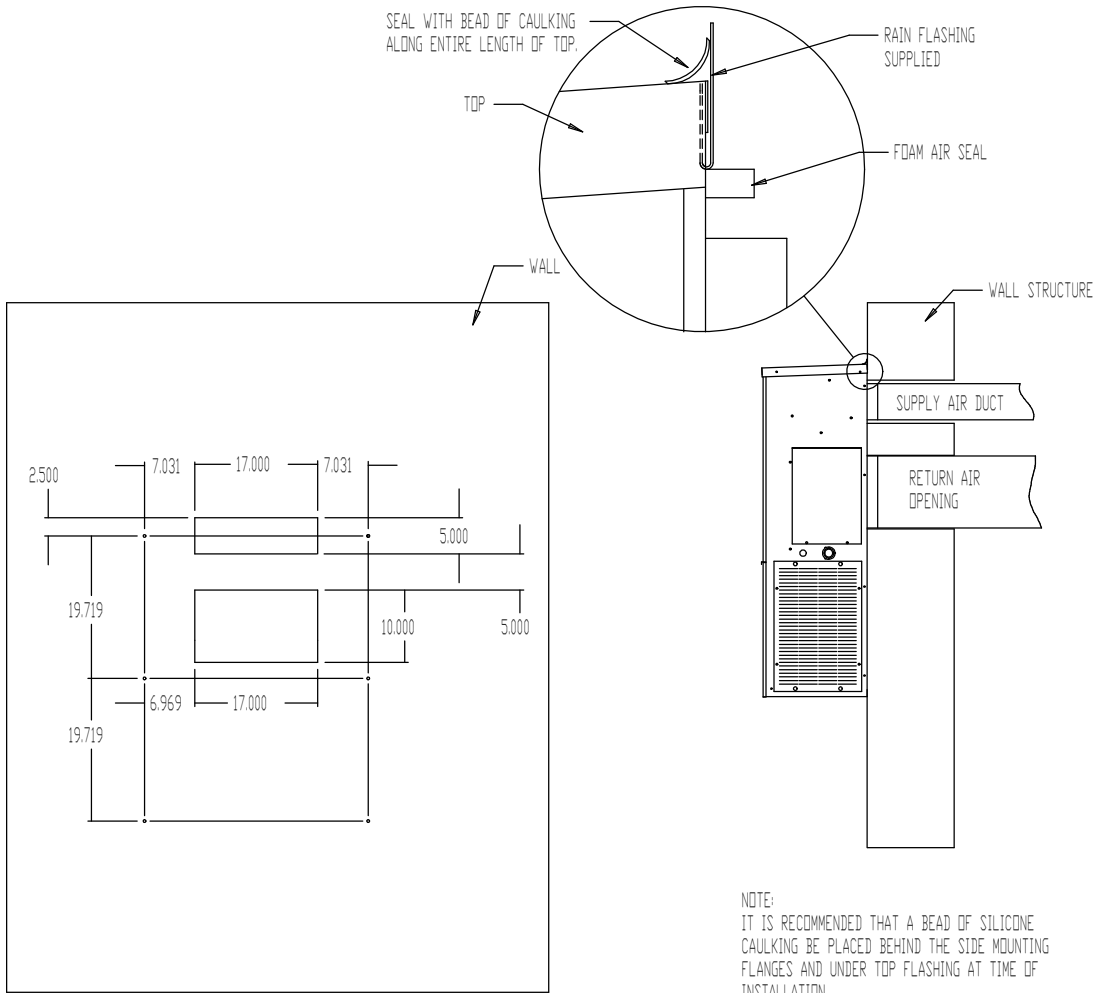

**WALL OPENING AND HOLE
 LOCATION VIEW**

MIS-3600

NOTE:
 IT IS RECOMMENDED THAT A BEAD OF SILICONE
 CAULKING BE PLACED BEHIND THE SIDE MOUNTING
 FLANGES AND UNDER TOP FLASHING AT TIME OF
 INSTALLATION.

FIGURE 3B
H24AA, H24LA Mounting Instructions

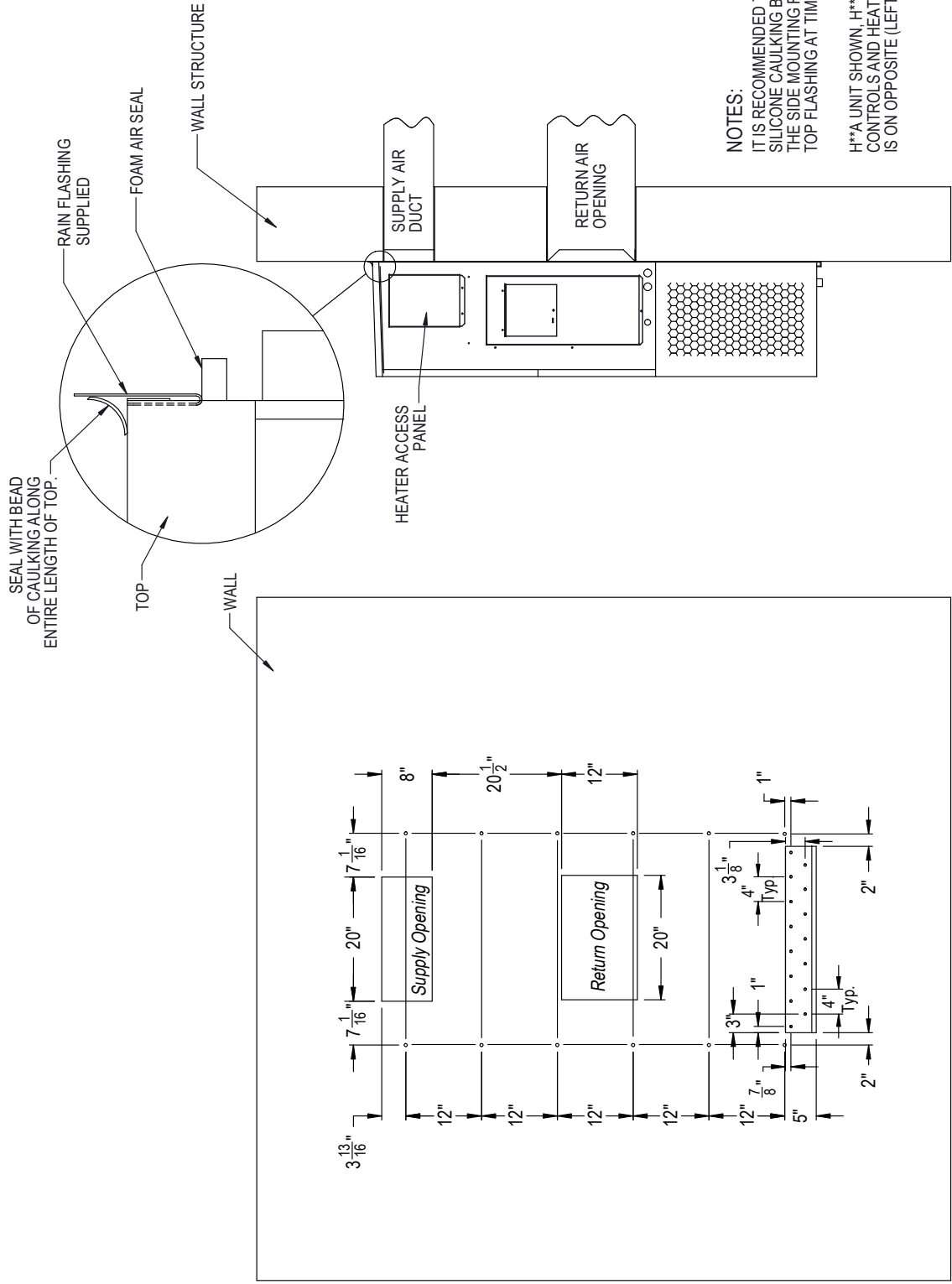

NOTES:
 IT IS RECOMMENDED THAT A BEAD OF SILICONE CAULKING BE PLACED BEHIND THE SIDE MOUNTING FLANGES AND UNDER TOP FLASHING AT TIME OF INSTALLATION.
 H**A UNIT SHOWN, H**L UNIT CONTROLS AND HEATER ACCESS IS ON OPPOSITE (LEFT) SIDE.

MIS-3658

Right Side View

Wall Opening and Hole Location View

FIGURE 3C
H36AA, H36LA Mounting Instructions

	A	B	C	D	E
REQUIRED DIMENSIONS TO MAINTAIN 1/4" MIN. CLEARANCE FROM COMBUSTIBLE MATERIALS	28 3/8	8 3/8	5 3/8	3 11/16	17 5/8
REQUIRED DIMENSIONS TO MAINTAIN RECOMMENDED 1" CLEARANCE FROM COMBUSTIBLE MATERIALS	29 7/8	9 7/8	4 5/8	4 7/16	16 7/8

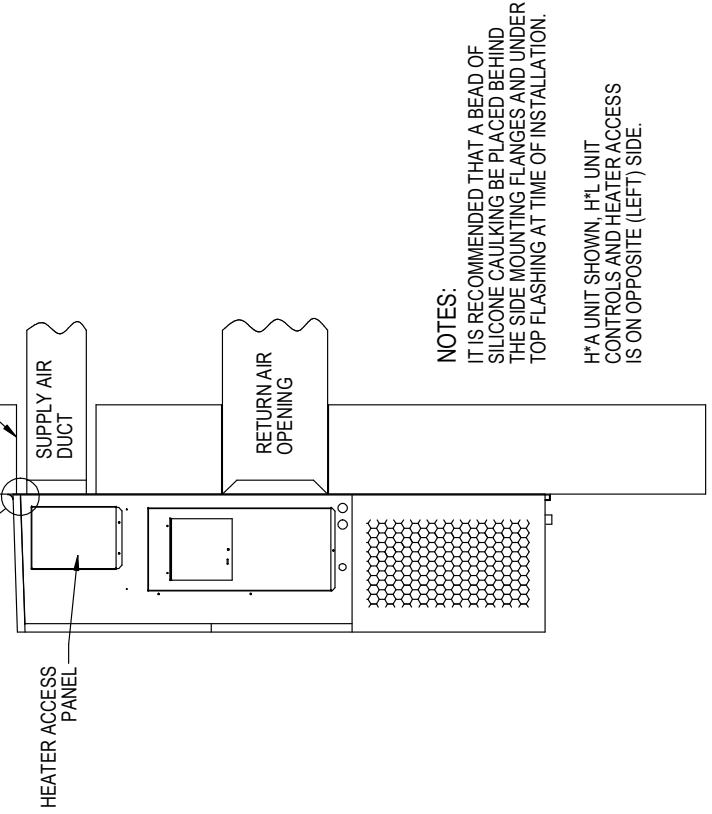
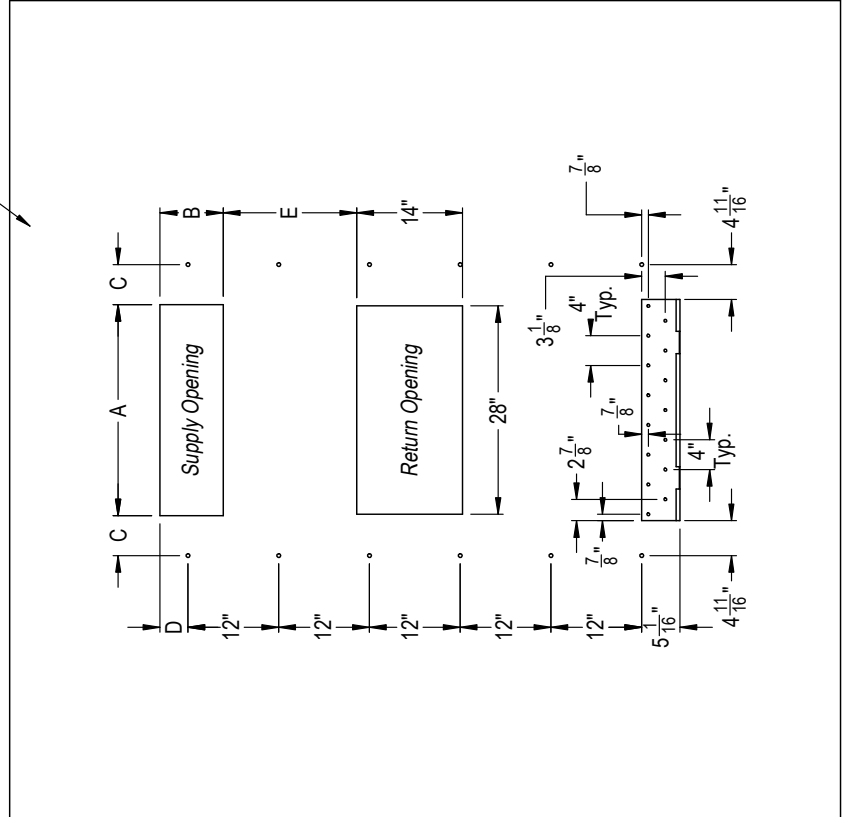
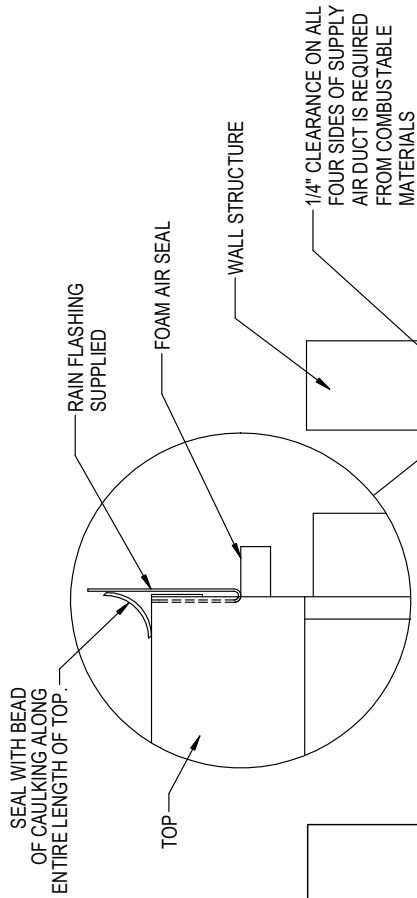

NOTES:
 IT IS RECOMMENDED THAT A BEAD OF SILICONE CAULKING BE PLACED BEHIND THE SIDE MOUNTING FLANGES AND UNDER TOP FLASHING AT TIME OF INSTALLATION.

H*A UNIT SHOWN. H*1 UNIT CONTROLS AND HEATER ACCESS IS ON OPPOSITE (LEFT) SIDE.

MIS-3659

Wall Opening and Hole Location View

H42AA, H42LA, H48AA, H48LA, H60AA, H60LA, H72AA, H72LA Mounting Instructions

FIGURE 3D

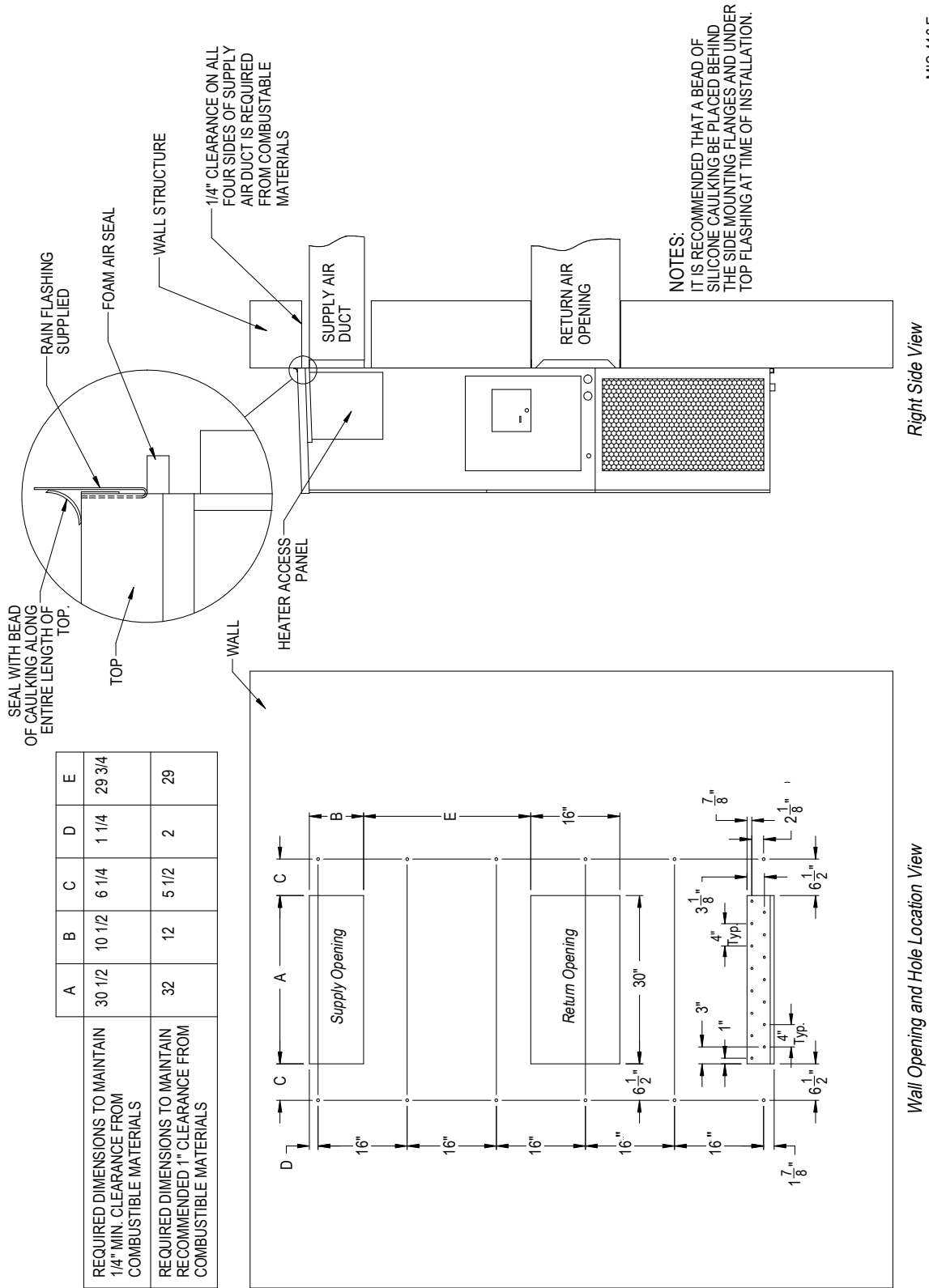
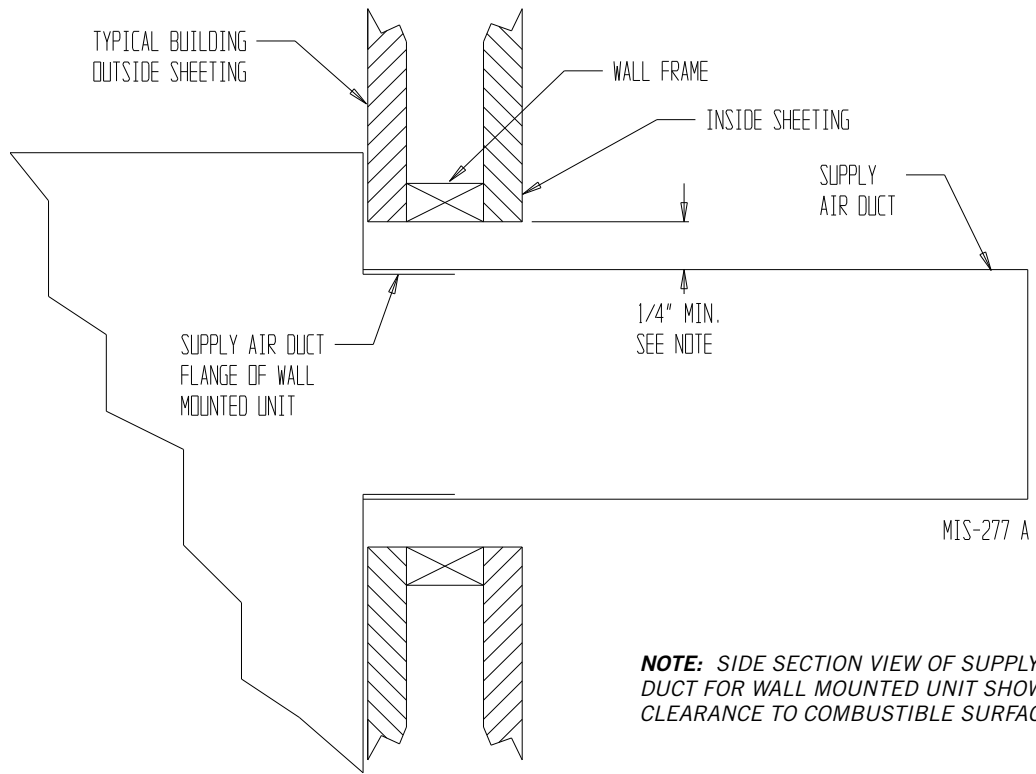

FIGURE 4
Electric Heat Clearance



NOTE: SIDE SECTION VIEW OF SUPPLY AIR DUCT FOR WALL MOUNTED UNIT SHOWING 1/4" CLEARANCE TO COMBUSTIBLE SURFACES.

WARNING

A **minimum** of 1/4" clearance must be maintained between the supply air duct and combustible materials. This is required for the first 3' of ducting.

It is important to insure that the 1/4" minimum spacing is maintained at all points.

Failure to do this could result in overheating the combustible material and may result in a fire causing damage, injury or death.

FIGURE 5
Wall Mounting Instructions

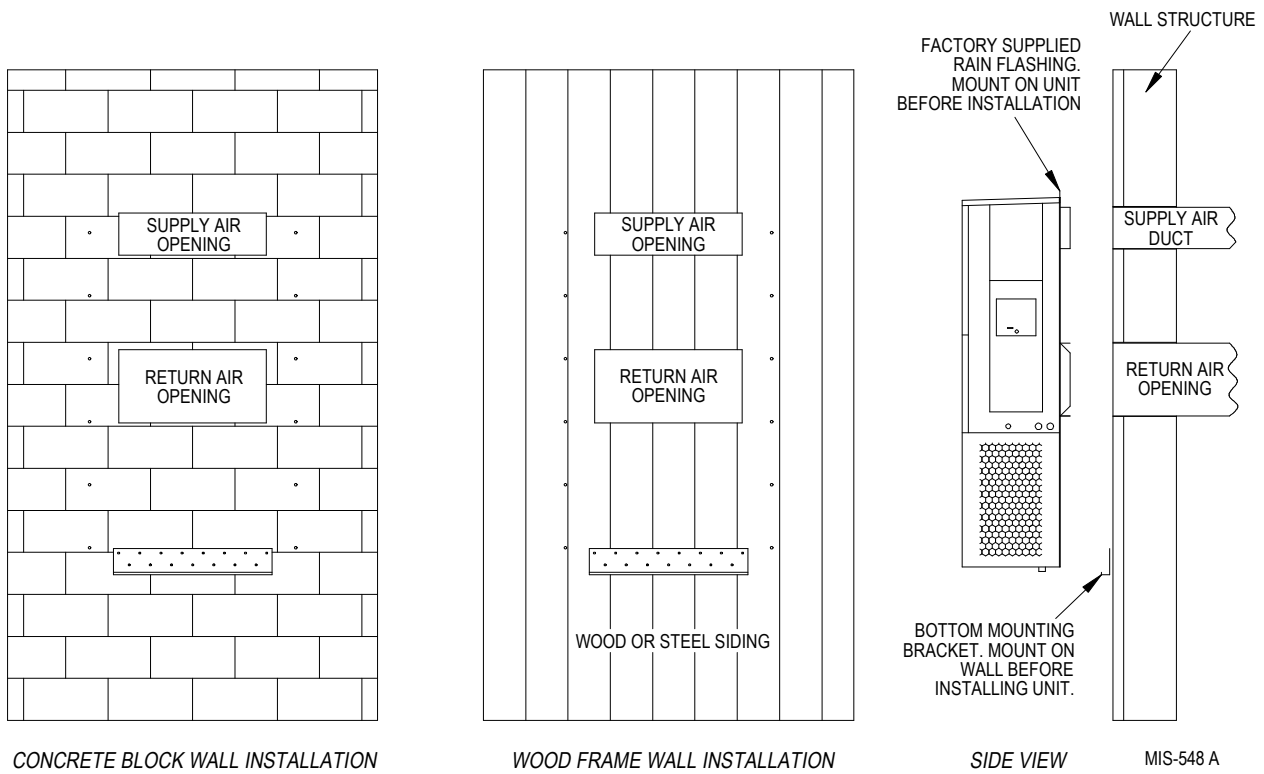

FIGURE 6
Wall Mounting Instructions

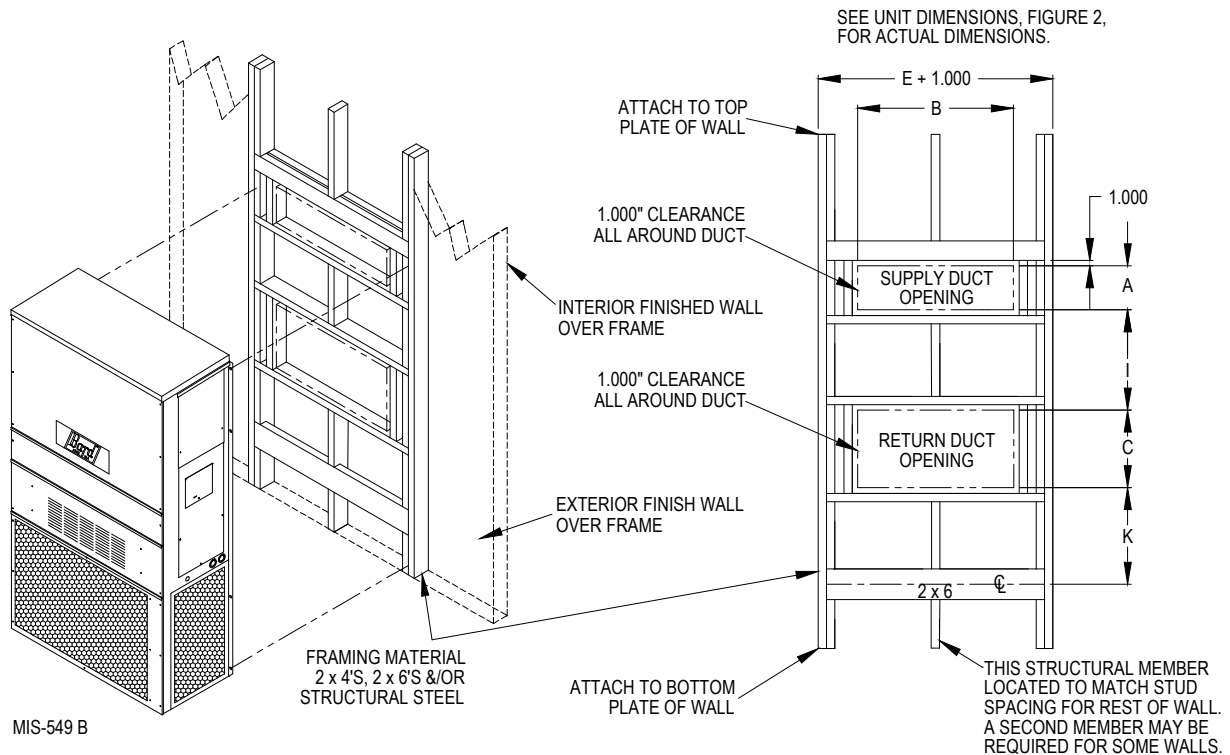
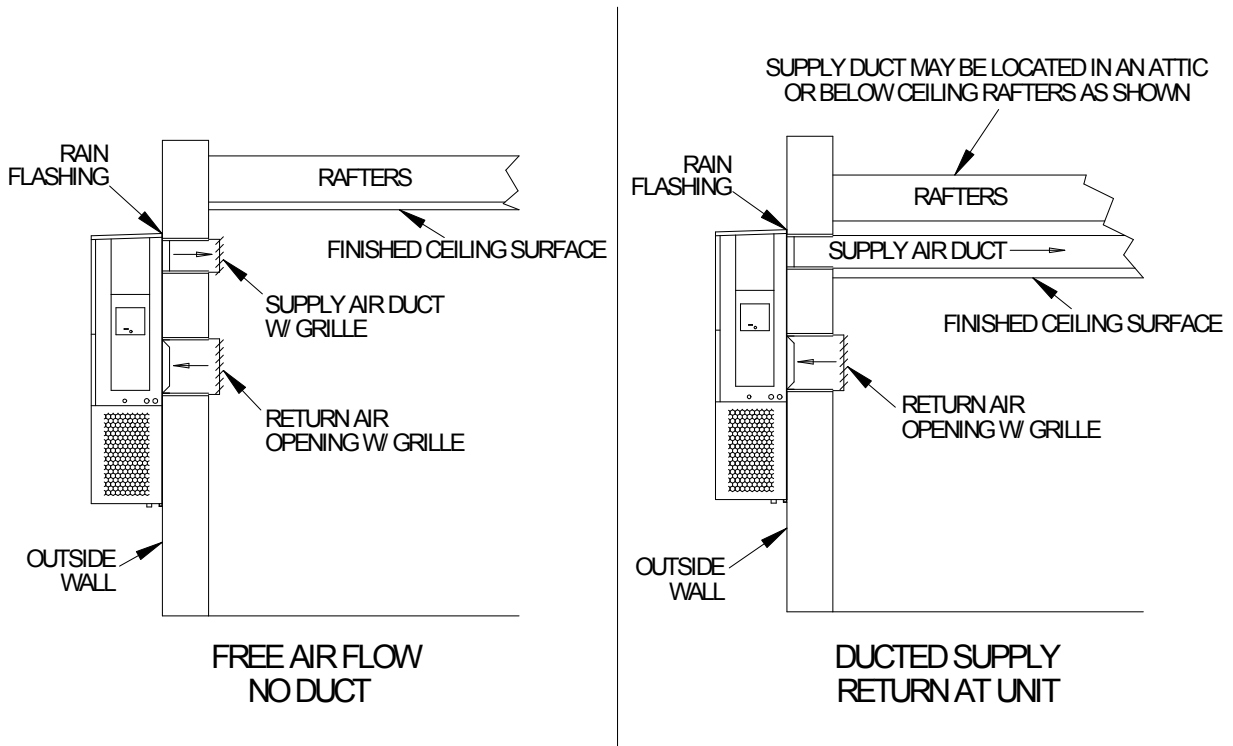

FIGURE 7
Common Wall Mounting Installations



WIRING – MAIN POWER

Refer to the unit rating plate for wire sizing information and maximum fuse or circuit breaker size. Each outdoor unit is marked with a “Minimum Circuit Ampacity”. This means that the field wiring used must be sized to carry that amount of current. Depending on the installed KW of electric heat, there may be two field power circuits required. If this is the case, the unit serial plate will so indicate. All models are suitable only for connection with copper wire. Each unit and/or wiring diagram will be marked “Use Copper Conductors Only”. These instructions **must be** adhered to. Refer to the National Electrical Code (NEC) for complete current carrying capacity data on the various insulation grades of wiring material. All wiring must conform to NEC and all local codes.

The electrical data lists fuse and wire sizes (75° C copper) for all models including the most commonly used heater sizes. Also shown are the number of field power circuits required for the various models with heaters.

The unit rating plate lists a “Maximum Time Delay Relay Fuse” or circuit breaker that is to be used with the equipment. The correct size must be used for proper circuit protection and also to assure that there will be no nuisance tripping due to the momentary high starting current of the compressor motor.

The disconnect access door on this unit may be locked to prevent unauthorized access to the disconnect. To convert for the locking capability, bend the tab located in the bottom left-hand corner of the disconnect opening under the disconnect access panel straight out. This tab will now line up with the slot in the door. When shut, a padlock may be placed through the hole in the tab preventing entry.

See “Start Up” section beginning on page 17 for important information on three phase scroll compressor start ups.

See Tables 4A and 4B (pages 22 and 23) for electrical specifications.

WIRING – LOW VOLTAGE WIRING

Low Voltage Connection

These units use a 24-volt AC low voltage circuit. Tables 11 and 12 on pages 26 and 27 show the low voltage connections for units operated with the MV Series controller or connected directly to a cooling/heating thermostat.

All models are equipped with dual primary voltage transformers. All equipment leaves the factory wired on 240V tap. For 208V operation, reconnect from 240V to 208V tap. The acceptable operating voltage range for the 240 and 208V taps are:

TAP	RANGE
240	253 – 216
208	220 – 187

NOTE: The voltage should be measured at the field power connection point in the unit and while the unit is operating at full load (maximum amperage operating condition).

DIRTY FILTER SWITCH AND RELAY

These units include an adjustable dirty filter indicator switch. This switch if connected to normally closed contacts on the filter relay wired to terminals 10 and 11 on the low voltage terminal block.

Filter Replacement Procedure

For units *not* equipped with economizer:

1. Turn off unit power.
2. Remove filter door.
3. Replace filter.
4. Press Reset button.
5. Verify filter light is off.
6. Replace filter door.
7. Turn on unit power.

For units *equipped* with economizer:

1. Turn off unit power.
2. Remove hood cover.
3. Remove mist eliminator. Inspect and clean if necessary.
4. Remove filter door.
5. Remove and replace filter.
6. Replace filter door.
7. Replace mist eliminator.
8. Replace hood cover.
9. Turn on unit power.

Filter Switch Adjustment

1. Turn off unit power.
2. Remove upper front door. Front screws on unit top can be removed for ease of removing upper front door.
3. Locate filter switch on control panel side next to blower assembly.
4. Remove single phillips head screw on front of cover. Remove cover.
5. Set pressure by adjusting knob. Do not adjust knob drastically to avoid nuisance alarm signalw or non-functionality.
6. Replace cover.
7. Replace upper front door.
8. Turn on unit power.

ECONOMIZER FAIL TIME DELAY RELAY

NOTE: Applies only to units with economizers.

These units employ a time delay relay to open the normally closed contacts at terminals 12 and 13 on the low voltage terminal block. This will activate an alarm signal on the MV Series controller. The time delay is set to 500 seconds as a factory default. Avoid adjustment to settings lower than 180 seconds.

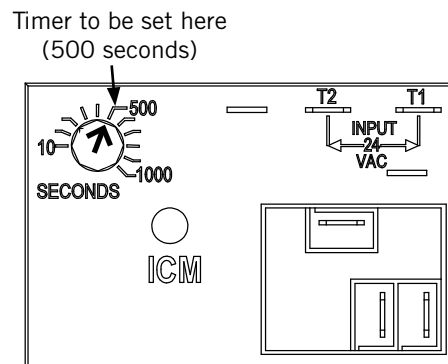

MIS-3054

THESE UNITS REQUIRE R-410A REFRIGERANT AND POLYOL ESTER OIL.

GENERAL

1. Use separate service equipment to avoid cross contamination of oil and refrigerants.
2. Use recovery equipment rated for R-410A refrigerant.
3. Use manifold gauges rated for R-410A (800 psi/250 psi low).
4. R-410A is a binary blend of HFC-32 and HFC-125.
5. R-410A is nearly azeotropic—similar to R-22 and R-12. Although nearly azeotropic, charge with liquid refrigerant.
6. R-410A operates at 40-70% higher pressure than R-22, and systems designed for R-22 cannot withstand this higher pressure.
7. R-410A has an ozone depletion potential of zero, but must be reclaimed due to its global warming potential.
8. R-410A compressors use Polyol Ester oil.
9. Polyol Ester oil is hygroscopic; it will rapidly absorb moisture and strongly hold this moisture in the oil.
10. A liquid line dryer must be used; even a deep vacuum will not separate moisture from the oil.
11. Limit atmospheric exposure to 15 minutes.
12. If compressor removal is necessary, always plug compressor immediately after removal. Purge with small amount of nitrogen when inserting plugs.

TOPPING OFF SYSTEM CHARGE

If a leak has occurred in the system, Bard Manufacturing **recommends** reclaiming, evacuating (see criteria above) and charging to the nameplate charge. If done correctly, topping off the system charge can be done without problems.

With R-410A, there are no significant changes in the refrigerant composition during multiple leaks and recharges. R-410A refrigerant is close to being an azeotropic blend (it behaves like a pure compound or single component refrigerant). The remaining refrigerant charge in the system may be used after leaks have occurred and then “top-off” the charge by utilizing the pressure charts on the inner control panel cover as a guideline.

REMEMBER: When adding R-410A refrigerant, it must come out of the charging cylinder/tank as a liquid to avoid any fractionation, and to insure optimal system performance. Refer to instructions for the cylinder that is being utilized for proper method of liquid extraction.

WARNING

Failure to conform to these practices could lead to damage, injury or death.

SAFETY PRACTICES

1. Never mix R-410A with other refrigerants.
2. Always use gloves and safety glasses. Polyol Ester oils can be irritating to the skin, and liquid refrigerant will freeze the skin.
3. Never use air and R-410A to leak check; the mixture may become flammable.
4. Do not inhale R-410A; the vapor attacks the nervous system, creating dizziness, loss of coordination and slurred speech. Cardiac irregularities, unconsciousness and ultimate death can result from breathing this concentration.
5. Do not burn R-410A. This decomposition produces hazardous vapors. Evacuate the area if exposed.
6. Use only cylinders rated DOT4BA/4BW 400.
7. Never fill cylinders over 80% of total capacity.
8. Store cylinders in a cool area, out of direct sunlight.
9. Never heat cylinders above 125°F.
10. Never trap liquid R-410A in manifold sets, gauge lines or cylinders. R-410A expands significantly at warmer temperatures. Once a cylinder or line is full of liquid, any further rise in temperature will cause it to burst.

IMPORTANT INSTALLER NOTE

For improved start up performance wash the indoor coil with dishwashing detergent.

HIGH PRESSURE AND LOW PRESSURE SWITCHES

All H**A/H**L wall mounted air conditioner series models are supplied with a remote reset for the high and low pressure switches. The first time the high or low pressure switches are tripped, they will reset automatically. If tripped a second time, reset the switches by turning the thermostat off, then back on again, resetting the compressor control module.

CONDENSER FAN OPERATION

NOTE: *These models are equipped with a low ambient control (LAC). The condenser fan motor may have a delayed start until system refrigerant operating pressure builds up. After starting, the fan motor may or may not cycle depending upon ambient conditions. This is normal operation.* The condenser fan motor on 230/208 volt, one and three phase, 60 HZ units is a two-speed motor that comes factory wired on high speed for peak performance. If ambient conditions permit, it can be reconnected to low speed (red wire) for lower sound level. See unit wiring diagram.

SERVICE HINTS

1. Caution owner/operator to maintain clean air filters at all times and to not needlessly close off supply and return air registers. This reduces airflow through the system, which shortens equipment service life as well as increasing operating costs.
2. Check all power fuses or circuit breakers to be sure they are the correct rating.
3. Periodic cleaning of the outdoor coil to permit full and unrestricted airflow circulation is essential.

SEQUENCE OF OPERATION

COOLING – 24VAC from MV controller at terminal 4 (Y) pulls in compressor contactor, starting the compressor and outdoor motor. (See **NOTE** under Condenser Fan Operation concerning the low ambient control.) Terminal 9 (G) indoor motor circuit is energized by the MV controller on any call for cooling operation or can be energized by manual fan switch on subbase for constant air circulation. A call for heating from the MV controller pulls in heat contactor, activating the strip heat and blower operation. On a call for second stage heat, R-W2 makes bringing on second heat contactor, if so equipped. See Table 1 on following page.

COMPRESSOR CONTROL MODULE

The compressor control module (CCM) is standard on all models covered by this manual. The compressor control module is an anti-short cycle/lockout timer with high and low pressure switch monitoring and alarm relay output.

Adjustable Delay-on-Make and Delay-on-Break Timer

On initial power up and any time power is interrupted to the unit, the delay-on-make period begins, which is the time set on the potentiometer (delay-on-break time) plus 10% of the delay-on-break setting (delay-on-break factory default is 2 minutes). When the delay-on-make period is complete and the high pressure switch and low pressure switch are closed, the compressor contactor is energized. Upon shutdown (end of the call for cooling), the delay-on-break timer starts and prevents restart (next call for cooling) until the delay-on-break period has expired.

During routine operation of the unit with no power interruptions, the compressor will operate on demand with no delay.

High Pressure Switch and Lockout Sequence

If the high pressure switch opens, the compressor contactor will de-energize immediately. The lockout timer will go into a *soft lockout* and stay in soft lockout until the high pressure switch closes and the delay-on-break time has expired. If the high pressure switch opens again in this same operating cycle, the unit will go into *manual lockout* condition and the alarm relay circuit will energize. Recycling the wall thermostat or main power resets the manual lockout.

Low Pressure Switch, Bypass and Lockout Sequence

If the low pressure switch opens for more than 120 seconds, the compressor contactor will de-energize and go into a soft lockout. Regardless the state of the low pressure switch, the contactor will re-energize after the delay-on-make time delay has expired. If the low pressure switch remains open, or opens again for longer than 120 seconds, the unit will go into manual lockout condition and the alarm relay circuit will energize. Recycling the wall thermostat or main power resets the manual lockout.

Alarm Relay Output

Alarm terminal is the output connection for applications where an alarm relay is employed. This terminal is powered whenever the compressor is locked out due to HPC or LPC sequences as described above.

NOTE: *Both high and low pressure switch controls are inherently automatic reset devices. The high pressure switch and low pressure switch cut out and cut in settings are fixed by specific air conditioner unit model. The lockout features, both soft and manual, are a function of the compressor control module.*

Adjustments

Adjustable Delay-on-Make and Delay-on-Break Timer

The potentiometer is used to select delay-on-break time from 30 seconds to 5 minutes. (The delay-on-break factory default is 2 minutes.) Delay-on-make (DOM) timing on power up and after power interruptions is equal to delay-on-break time plus 10% of delay-on-break (DOB) setting:

0.5 minute (30 seconds) DOB = 123 second DOM
 1.0 minute (60 seconds) DOB = 126 second DOM
 2.0 minute (120 seconds) DOB = 132 second DOM
 3.0 minute (180 seconds) DOB = 138 second DOM
 4.0 minute (240 seconds) DOB = 144 second DOM
 5.0 minute (300 seconds) DOB = 150 second DOM

During routine operation of the unit with no power interruptions, the compressor will operate on demand with no delay.

Typical Settings for Dual Unit Installation:

Unit 1: DOB set at 2 minutes and DOM is 132 seconds
 Unit 2: DOB set at 4 minutes and DOM is 144 seconds

PRESSURE SERVICE PORTS

High and low pressure service ports are installed on all units so that the system operating pressures can be observed. A pressure table can be found on page 21 covering all models. It is imperative to match the correct pressure table to the unit by model number.

TABLE 1
Sequence of Operation

Terminal	Description	Use	Revision "2" Reference
1	Compressor on Output Signal from Jade to MV	Economizer Only	"A"
2	24VAC HOT from Terminal 2 Connected to Unit Transformer	24V HOT	"R"
3	24VAC COMMON from Unit Transformer to MV	24V COMMON	"C"
4	Unit Compressor Operation	Cooling Operation	"Y"
5	Close Damper Input (Close Blade 100%)	Economizer Only	"F"
6	Electric Heat On Operation, Stage 1 and 2	Heating Operation	"W1"
7	1st Stage Cooling Input, 1st Stage Cooling Signal to Jade	Economizer Only	"Y1"
8	2nd Stage Cooling Input, 2nd Stage Cooling Signal to Jade	Economizer Only	"Y2"
9	Blower Operation (Indoor Blower On)	Blower Operation	"G"
10	Filter Switch Normally Closed Dry Contacts	Alarm Signal	"4"
11	Filter Switch Normally Closed Dry Contacts	Alarm Signal	"5"
12	Blade Switch Delay Relay Normally Closed Dry Contacts	Economizer Only	"8"
13	Blade Switch Delay Relay Normally Closed Dry Contacts	Economizer Only	"9"
14	Occupied Signal Input, Econ Emergency Open (Open Blade 100%)	Economizer Only	"E"
15	Econ Open Output (6V HOT, 24V HOT after Blade Open 100% and delay)	Economizer Only	"10"
16	Alarm Relay Common Dry Contact	Comp Alarm Signal	"3"
17	Alarm Relay Normally Open Dry Contact	Comp Alarm Signal	"2"
18	Alarm Relay Normally Closed Dry Contact	Comp Alarm Signal	"1"
19	24VAC HOT to Terminal 2 from Unit Transformer Through Smoke Alarm Jumper Wire*	24V HOT	"RT"
20	2nd Stage Heating On Operated Through Jumper to Terminal 6	Heating Operation, 2nd Stage	"W2"
21	Blade Switch Terminal 24V HOT When Blade is Open, Sends Signal from Switch to Delay Relay	Economizer Only	"7"

* Replace jumper wire with smoke alarm connections to interrupt 24VAC unit power if smoke alarm is used in shelter. Jumper can also be removed to break 24VAC power to unit.

SERVICE

FAN BLADE SETTING DIMENSIONS

The correct fan blade setting for proper air delivery across the outdoor coil is shown in Figure 8. Refer to Table 2 for unit specific dimension. Dimension "A" is the distance between the closest point on fan blade to motor mount leg.

Any service work requiring removal or adjustment in the fan and/or motor area will require that the dimensions below be checked and blade adjusted in or out on the motor shaft accordingly.

FIGURE 8
Fan Blade Setting

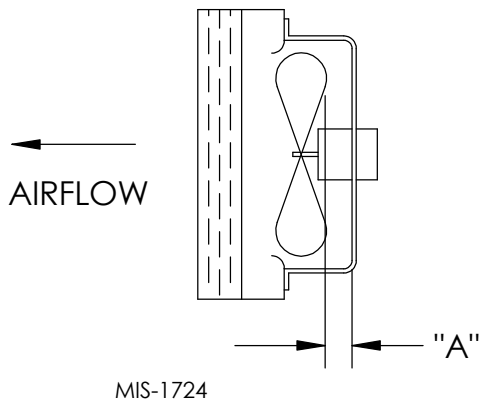

TABLE 2
Fan Blade Dimension

Model	Dimension A
H12	2.25"
H24	1.00"
H36	1.25"
H42 H48 H60 H72	1.75"

REMOVAL OF FAN SHROUD

1. Disconnect all power to the unit.
2. Remove screws holding both grilles, one on each side of unit, and remove grilles.
3. Remove screws holding fan shroud to condenser coil and unit base.
4. Disconnect condenser fan motor from control panel wiring.
5. Slide complete motor, fan blade and shroud assembly out appropriate side of the unit (dependent on whether it is a right hand or left hand unit).
6. Service motor/fan as needed.
7. Reverse steps to re-install. Make sure fan blade setting dimension is checked and re-adjusted if necessary.

R-410A REFRIGERANT CHARGE

This unit was charged at the factory with the quantity of refrigerant listed on the serial plate. AHRI capacity and efficiency ratings were determined by testing with this refrigerant charge quantity.

The pressure table on the following page shows nominal pressures for the units. Since many installation specific situations can affect the pressure readings, this information should only be used by certified technicians as a guide for evaluating proper system performance. They shall not be used to adjust charge. If charge is in doubt, reclaim, evacuate and recharge the unit to the serial plate charge.

TABLE 3
Cooling Pressure

Air Temperature Entering Outdoor Coil °F

Model	Return Air Temp (DB/WB)	Pressure	75	80	85	90	95	100	105	110	115	120	125
H12A	75/62	Low Side High Side	125 296	129 316	132 336	134 359	137 381	139 405	141 429	144 454	146 481	148 508	150 537
	80/67	Low Side High Side	134 304	138 324	141 345	143 368	146 391	149 415	151 440	154 466	156 493	158 521	160 551
	85/72	Low Side High Side	139 315	143 335	146 357	148 381	151 405	154 430	156 455	159 482	161 510	164 539	167 570
H24A/L	75/62	Low Side High Side	123 314	124 334	126 355	128 377	129 401	131 425	133 451	135 479	137 507	139 536	141 567
	80/67	Low Side High Side	132 322	133 343	135 364	137 387	138 411	140 436	142 463	144 491	146 520	149 550	151 582
	85/72	Low Side High Side	137 333	138 355	140 377	142 401	143 425	145 451	147 479	149 508	151 538	154 569	156 602
H36A/L	75/62	Low Side High Side	117 323	120 346	122 370	124 394	127 419	129 446	131 473	134 500	136 528	137 558	138 587
	80/67	Low Side High Side	125 331	128 355	130 379	133 404	136 430	138 457	140 485	143 513	145 542	147 572	148 602
	85/72	Low Side High Side	129 343	132 367	135 392	138 418	141 445	143 473	145 502	148 531	150 561	152 592	153 623
H42A/L	75/62	Low Side High Side	123 323	125 346	128 371	130 395	132 421	135 447	137 474	138 501	140 528	142 558	144 587
	80/67	Low Side High Side	132 331	134 355	137 380	139 405	141 432	144 458	146 486	148 514	150 542	152 572	154 602
	85/72	Low Side High Side	137 343	139 367	142 393	144 419	146 447	149 474	151 503	153 532	155 561	157 592	159 623
H48A/L	75/62	Low Side High Side	120 330	122 353	125 377	127 402	130 428	132 454	134 482	136 510	137 540	139 570	141 601
	80/67	Low Side High Side	128 338	131 362	134 387	136 412	139 439	141 466	143 494	145 523	147 554	149 585	151 616
	85/72	Low Side High Side	132 350	136 375	139 401	141 426	144 454	146 482	148 511	150 541	152 573	154 605	156 638
H60A/L	75/62	Low Side High Side	127 344	129 362	131 380	134 401	136 421	137 444	140 467	142 492	145 518	148 545	151 573
	80/67	Low Side High Side	136 353	138 371	140 390	143 411	145 432	147 455	150 479	152 505	155 531	158 559	161 588
	85/72	Low Side High Side	141 365	143 384	145 404	148 425	150 447	152 471	155 496	157 523	160 550	164 579	167 609
H72A/L	75/62	Low Side High Side	117 332	119 353	121 376	122 402	124 427	126 454	128 483	130 512	132 542	134 574	136 607
	80/67	Low Side High Side	125 340	127 362	129 386	131 412	133 438	135 466	137 495	139 525	141 556	143 589	145 623
	85/72	Low Side High Side	129 352	131 375	134 400	136 426	138 453	140 482	142 512	144 543	146 575	148 610	150 645

Low side pressure ± 4 PSIG
High side pressure ± 10 PSIG

Tables are based upon rated CFM (airflow) across the evaporator coil. If there is any doubt as to correct operating charge being in the system, the charge should be removed, system evacuated and recharged to serial plate charge weight.

NOTE: Pressure table based on high speed condenser fan operation. If condensing pressures appear elevated, check condenser fan wiring. See "Condenser Fan Operation".

TABLE 4A
Electrical Specifications H*A Series**

MODEL	Rated Volts & Phase	No. Field Power Circuits	Single Circuit				Multiple Circuit																		
			① Minimum Circuit Ampacity	② Maximum External Fuse or Circuit Breaker	③ Field Power Wire Size	④ Ground Wire	① Minimum Circuit Ampacity			② Maximum External Fuse or Circuit Breaker			③ Field Power Wire Size			④ Ground Wire Size									
							Ckt. A	Ckt. B	Ckt. C	Ckt. A	Ckt. B	Ckt. C	Ckt. A	Ckt. B	Ckt. C	Ckt. A	Ckt. B	Ckt. C							
H12AA-A0Z A03 A05	230/208-1	1 1 1	9 20 27	15 20 30	14 12 10	14 12 10																			
H24AA-A00, A04 A05 A08 A10	230/208-1	1 1 1 1 1	21 25 30 46 56	30 30 30 50 60	10 10 10 8 6	10 10 10 10 10																			
H36AA-A00*, A0Z* A05* A08 A10* A15	230/208-1	1 1 1 1 1 or 2	29 32 47 58 84	35 35 50 60 90	8 8 8 6 4	10 10 10 10 8												58	26	60	30	6	10	10	10
H42AA-A00, A0Z A05 A10 A15 A20	230/208-1	1 1 1 1 or 2 1 or 2	32 32 58 84 110	50 50 60 90 125	8 8 6 4 2	10 10 10 8 6												58	26	60	30	6	10	10	10
H48AA-A00, A0Z A05 A10 A15 A20	230/208-1	1 1 1 1 or 2 1 or 2	34 34 58 84 110	50 50 60 90 125	8 8 6 4 2	10 10 10 8 6												58	26	60	30	6	10	10	10
H60AA-A00, A0Z A05 A10 A15 A20	230/208-1	1 1 1 1 or 2 1 or 2	38 38 60 86 112	60 60 60 90 125	8 8 6 3 2	10 10 10 8 6												60	26	60	30	6	10	10	10
H72AA-A00, A0Z A05 A10 A15 A20	230/208-1	1 1 1 1 or 2 1 or 3	58 58 62 88 114	60 60 70 90 125	6 6 6 3 2	10 10 8 8 6												58	26	60	30	6	10	10	10

① These "Minimum Circuit Ampacity" values are to be used for sizing the field power conductors. Refer to the National Electrical code (latest version), Article 310 for power conductor sizing.
 ② Maximum size of the time delay fuse or circuit breaker for protection of field wiring conductors.
 ③ Based on 75°C copper wire. All wiring must conform to the National Electrical Code and all local codes.
 * Top outlet supply option is available only factory installed and only on the selected models.

CAUTION: When more than one field power circuit is run through one conduit, the conductors must be derated. Pay special attention to Note 8 of Table 310 regarding Ampacity Adjustment Factors when more than three (3) current carrying conductors are in a raceway.

IMPORTANT: While this electrical data is presented as a guide, it is important to electrically connect properly sized fuses and conductor wires in accordance with the National Electrical Code and all local codes.

TABLE 4B
Electrical Specifications H*L Series**

MODEL	Rated Volts & Phase	No. Field Power Circuits	Single Circuit				Dual Circuit							
			① Minimum Circuit Ampacity	② Maximum External Fuse or Circuit Breaker	③ Field Power Wire Size	③ Ground Wire	① Minimum Circuit Ampacity		② Maximum External Fuse or Circuit Breaker		③ Field Power Wire Size		③ Ground Wire Size	
							Ckt. A	Ckt. B	Ckt. A	Ckt. B	Ckt. A	Ckt. B	Ckt. A	Ckt. B
H24LA-A00, A0Z A05 A08 A10	230/208-1	1 1 1 1	21 30 46 56	30 30 50 60	10 10 8 6	10 10 10 10								
H36LA-A00, A0Z A05 A10 A15	230/208-1	1 1 1 1 or 2	29 32 58 84	35 35 60 90	8 8 6 4	10 10 10 8	58	26	60	30	6	10	10	10
H42LA-A00, A0Z A05 A10 A15	230/208-1	1 1 1 1 or 2	32 32 58 84	50 50 60 90	8 8 6 4	10 10 10 8	58	26	60	30	6	10	10	10
H48LA-A00, A0Z A05 A10 A15	230/208-1	1 1 1 1 or 2	34 34 58 84	50 50 60 90	8 8 6 4	10 10 10 8	58	26	60	30	6	10	10	10
H60LA-A00, A0Z A05 A10 A15	230/208-1	1 1 1 1 or 2	38 38 60 86	60 60 60 90	8 8 6 3	10 10 10 8	60	26	60	30	6	10	10	10
H72LA-A00, A0Z A05 A10 A15	230/208-1	1 1 1 1 or 2	58 58 62 88	60 60 70 90	6 6 6 3	10 10 8 8	58 58	26 52	60 60	30 60	6 6	10 6	10 10	10 10

① These "Minimum Circuit Ampacity" values are to be used for sizing the field power conductors. Refer to the National Electrical code (latest version), Article 310 for power conductor sizing.

② Maximum size of the time delay fuse or circuit breaker for protection of field wiring conductors.

③ Based on 75°C copper wire. All wiring must conform to the National Electrical Code and all local codes.

* Top outlet supply option is available only factory installed and only on the selected models.

CAUTION: When more than one field power circuit is run through one conduit, the conductors must be derated. Pay special attention to Note 8 of Table 310 regarding Ampacity Adjustment Factors when more than three (3) current carrying conductors are in a raceway.

IMPORTANT: While this electrical data is presented as a guide, it is important to electrically connect properly sized fuses and conductor wires in accordance with the National Electrical Code and all local codes.

TABLE 5
Recommended Airflow

Model	Nominal Rated CFM *	Nominal Rated ESP *	Recommended Airflow Range	Factory Speed Connection
H12A	400	.20	360 - 530	Single
H24A, H24L	800	.30	700 - 950	Single
H36A, H36L	1100	.30	1000 - 1300	High
H42A, H42L	1350	.40	1250 - 1600	Low
H48A, H48L	1550	.35	1450 - 1750	High
H60A, H60L	1800	.30	1700 - 2000	High
H72A, H72L	1900	.25	1800 - 2100	Medium

* Rated CFM and ESP on factory speed connection.

TABLE 6
Indoor Blower Performance

Speed	H12		H24		H36				H42				H48				H60				H72					
	Single		Single		High		Low		High		Low		High		Low		High		Low		High		Medium		Low	
ESP (In. H ₂ O)	Dry Coil	Wet Coil	Dry Coil	Wet Coil	Dry Coil	Wet Coil	Dry Coil	Wet Coil	Dry Coil	Wet Coil	Dry Coil	Wet Coil	Dry Coil	Wet Coil	Dry Coil	Wet Coil	Dry Coil	Wet Coil	Dry Coil	Wet Coil	Dry Coil	Wet Coil	Dry Coil	Wet Coil	Dry Coil	Wet Coil
0.0	530	500	1010	975	1400	1310	965	955	1980	1940	1800	1705	2000	1940	1750	1700	2105	2010	1540	1460	2255	2155	2075	2015	1995	1930
0.1	475	450	960	925	1340	1260	940	930	1905	1880	1700	1640	1910	1865	1675	1615	2045	1960	1480	1395	2185	2095	2010	1965	1950	1870
0.2	425	400	905	870	1265	1185	905	890	1820	1760	1615	1565	1820	1770	1600	1540	1970	1885	1400	1315	2115	2035	1960	1915	1885	1825
0.3	375	360	835	800	1180	1100	860	850	1735	1665	1530	1450	1720	1605	1500	1425	1895	1800	1300	1220	2050	1970	1915	1865	1835	1785
0.4	315	300	750	720	1080	1010	800	785	1615	1565	1425	1350	1575	1500	1375	1320	1800	1700	1220	1150	1985	1920	1860	1815	1780	1720
0.5	N/A	N/A	640	610	970	895	705	680	1510	1380	1100	1000	1420	1190	1075	1030	1705	1605	1110	1070	1925	1855	1810	1765	1725	1615

TABLE 7
Maximum ESP of Operation
Electric Heat Only

Model	H12A	H24A/L	H36A/L				H42A/L, H48A/L		H60A/L, H72A/L	
Outlet	FRONT	FRONT	FRONT		TOP		FRONT		FRONT	
Speed	Single	Single	High	Low	High	Low	High	Low	High	Low
-A0Z	.35	.50	.50	.50	.50	.50	.50	.50	.50	.50
-A03	.35				.50	.45				
-A04		.50	.50	.50			.50	.50	.50	.50
-A05	.35	.50	.50	.50						
-A08			.50	.45	.50	.35	.50	.50	.50	.50
-A10			.40	.35			.50	.50	.50	.50
-A15							.50	.45	.50	.40
-A20										

TABLE 8A
H12A Electric Heat

Models (KW)	240V-1		208V-1	
	Amps	BTUH	Amps	BTUH
3	15.0	12760	13.0	9705
5	20.8	17540	18.1	13275

TABLE 8B
H24-72A/L Electric Heat

Models (KW)	240V-1		208V-1	
	Amps	BTUH	Amps	BTUH
3	15.0	12760	13.0	9705
4	16.7	13650	14.4	10240
5	20.8	17540	18.1	13275
8	33.3	27300	28.8	20475
10	41.6	34130	36.2	25600
15	62.5	51250	54.0	38400
20	83.2	68260	72.1	51200

TABLE 9
Optional Accessories

Right Hand Units		H12AA-A	H24AA-A	H36AA-A	H42AA-A	H48AA-A	H60AA-A	H72AA-A	Left Hand Units							H24LA-A	H36LA-A	H42LA-A	H48LA-A	H60LA-A	H72LA-A
Heater Kits	901147-A03	X							Heater Kits	EHWAO2A-A05LB	X										
	901147-A05	X								EHW02A-A08LB	X										
	EHWAO2-A05B		X							EHWAO2-A10LB	X										
	EHW02A-A08B		X							EHWAO3-A05LB		X									
	EHWAO2A-A10B		X							EHWAO3-A10LB		X									
	EHWAO24-A04B		X							EHWAO3-A15LB		X									
	EHWAO3-A05B			X						EHW4TA-A05L			X	X	X						
	EHWAO3-A08B			X						EHWAO5-A10LB			X	X	X						
	EHWAO3-A10B			X						EHWAO5-A15LB			X	X	X						
	EHWAO3-A15B			X						EHW6TA-A05L										X	
	EHW4TA-A05				X	X				EHW72A-A10LB										X	
	EHWAO5-A10B				X	X	X			EHW72A-A15LB										X	
	EHWAO5-A15B				X	X	X			Circuit Breakers (WMCB) & Pull Disconnects (WMPD)	WMCB-03A	X									
	EHWAO5-A20B				X	X	X				WMCB-05A		X								
	EHW5TA-A05						X	X			WMCB-08A			X	X						
	EHW72A-A10B							X			WMCB-09A						X	X			
	EHW72A-A15B							X													
EHW72A-A20B							X														
Circuit Breakers (WMCB) & Pull Disconnects (WMPD)	WMCB-03A		X																		
	WMCB-05A			X																	
	WMCB-08A				X	X															
	WMCB-09A						X	X													

TABLE 10
Vent and Control Options

Part Number	Description	H12	H24	H36	H42	H48	H60	H72
CMC-14	ODT		X	X			X	
CMC-15	Start Kit (230V 1-Phase)		X	X			X	
CMC-23	DDC	X	X	X				
CMC-24	DDC						X	
CMC-28	LAC	X	X	X			X	
BOP-1A		X						
BOP-2	Blank Off Plate		X					
EWM1-E	Economizer - Bldg. Equipment, Enthalpy	X						
EWM1-T	Economizer - Bldg. Equipment, DB Temp.	X						
EWM2-E	Economizer - Bldg. Equipment, Enthalpy		X					
EWM2-T	Economizer - Bldg. Equipment, DB Temp.		X					
BOP-3	Blank Off Plate			X				
EWM3-E	Economizer - Bldg. Equipment, Enthalpy			X				
EWM3-T	Economizer - Bldg. Equipment, DB Temp.			X				
BOP-5	Blank Off Plate						X	
EWM5-E	Economizer - Bldg. Equipment, Enthalpy						X	
EWM5-T	Economizer - Bldg. Equipment, DB Temp.						X	

TABLE 11
Unit Low Voltage Terminal Connection Chart – MV Series Controller

Terminal	Description	MV Terminal Connection	Revision "2" Reference
1	Compressor on Output Signal from Jade to MV	"A" on Relay Board	"A"
2	24VAC HOT from Terminal 2 Connected to Unit Transformer to MV	"R" on Relay Board	"R"
3	24VAC COMMON from Unit Transformer to MV	"C" on Relay Board	"C"
4	Unit Compressor Operation, Unit Receives Signal from MV for Compressor/ Condenser Fan On	"Y" on Relay Board	"Y"
5	Close Damper Input (Close Blade 100%), Unit Receives Signal from MV	"F" on Relay Board	"F"
6	Electric Heat On Operation, Stage 1 and 2, Unit Receives Signal from MV	"W" on Relay Board	"W1"
7	1st Stage Cooling Input, 1st Stage Cooling Signal to Jade from MV	"Y1" on Relay Board	"Y1"
8	2nd Stage Cooling Input, 2nd Stage Cooling Signal to Jade from MV	"Y2" on Relay Board	"Y2"
9	Blower Operation (Indoor Blower On), Unit Receives Signal from MV	"G" on Relay Board	"G"
10	Filter Switch Normally Closed Dry Contacts, MV Signals Dirty Filter Alarm	"4" on Relay Board	"4"
11	Filter Switch Normally Closed Dry Contacts, MV Signals Dirty Filter Alarm	"5" on Relay Board	"5"
12	Blade Switch Delay Relay Normally Closed Dry Contacts, MV Signals Blade Switch Fail Alarm*	"8" on Relay Board	"8"
13	Blade Switch Delay Relay Normally Closed Dry Contacts, MV Signals Blade Switch Fail Alarm*	"9" on Relay Board	"9"
14	Occupied Signal Input, Econ Emergency Open (Open Blade 100%), Unit Receives Signal from MV	"ECONE" on Alarm Board	"E"
15	Econ Open Output (6V HOT, 24V HOT after Blade Open 100% and Delay), Sends Signal to MV	"DAMPER" on Comm Board	"10"
16	Alarm Relay Common Dry Contact, MV Signals Compressor Fail Alarm	"LOCKOUT 3" on Alarm Board	"3"
17	Alarm Relay Normally Open Dry Contact, MV Signals Compressor Fail Alarm	"LOCKOUT 2" on Alarm Board	"2"
18	Alarm Relay Normally Closed Dry Contact	<i>Not Used on MV</i>	"1"
19	24VAC HOT to Terminal 2 from Unit Transformer Through Smoke Alarm Jumper Wire**	Building Smoke Alarm (optional)	"RT"
20	2nd Stage Heating On Operated Through Jumper to Terminal 6	<i>Not Used on MV</i>	"W2"
21	Blade Switch Terminal 24V HOT When Blade is Open, Sends Signal from Switch to Delay Relay	<i>Not Used on MV</i>	"7"

* Blade switch delay relay fail alarm set to 500 second delay from factory.

** Replace jumper wire with smoke alarm connections to interrupt 24VAC unit power if smoke alarm is used in shelter. Jumper can also be removed to break 24VAC power to unit.

TABLE 12
Unit Low Voltage Terminal Connection Chart – Cooling/Heating Thermostat

Terminal	Description	Thermostat Connection	Revision "2" Reference
1	Compressor on Output Signal from Jade	<i>Not Used</i>	"A"
2	24VAC HOT from Terminal 2 Connected to Unit Transformer to Thermostat	"R" on Tstat	"R"
3	24VAC COMMON from Unit Transformer to Thermostat	"C" on Tstat	"C"
4	Unit Compressor Operation, Unit Receives Signal from MV for Compressor/ Condenser Fan On	"Y" on Tstat	"Y"
5	Close Damper Input (Close Blade 100%)	<i>Not Used</i>	"F"
6	Electric Heat On Operation, Stage 1 and 2, Unit Receives Signal from Thermostat	"W" on Tstat	"W1"
7	1st Stage Cooling Input, 1st Stage Cooling Signal – Economizer Use Only	Economizer 24V Signal	"Y1"
8	2nd Stage Cooling Input, 2nd Stage Cooling Signal – Economizer Use Only	Economizer 24V Signal	"Y2"
9	Blower Operation (Indoor Blower On), Unit Receives Signal from Thermostat	"G" on Tstat	"G"
10	Filter Switch Normally Closed Dry Contacts	<i>Not Used</i>	"4"
11	Filter Switch Normally Closed Dry Contacts	<i>Not Used</i>	"5"
12	Blade Switch Delay Relay Normally Closed Dry Contacts	<i>Not Used</i>	"8"
13	Blade Switch Delay Relay Normally Closed Dry Contacts	<i>Not Used</i>	"9"
14	Occupied Signal Input, Econ Emergency Open (Open Blade 100%)	<i>Not Used</i>	"E"
15	Econ Open Output (6V HOT, 24V HOT after Blade Open 100% and Delay)	<i>Not Used</i>	"10"
16	Alarm Relay Common Dry Contact	<i>Not Used</i>	"3"
17	Alarm Relay Normally Open Dry Contact	<i>Not Used</i>	"2"
18	Alarm Relay Normally Closed Dry Contact	<i>Not Used</i>	"1"
19	24VAC HOT to Terminal 2 from Unit Transformer Through Smoke Alarm Jumper Wire*	Building Smoke Alarm (optional)	"RT"
20	2nd Stage Heating On Operated Through Jumper to Terminal 6	<i>Not Used</i>	"W2"
21	Blade Switch Terminal 24V HOT When Blade is Open, Sends Signal from Switch to Delay Relay	<i>Not Used</i>	"7"

* Replace jumper wire with smoke alarm connections to interrupt 24VAC unit power if smoke alarm is used in shelter. Jumper can also be removed to break 24VAC power to unit.

FIGURE 9A
H12AA Wiring Diagram – Top

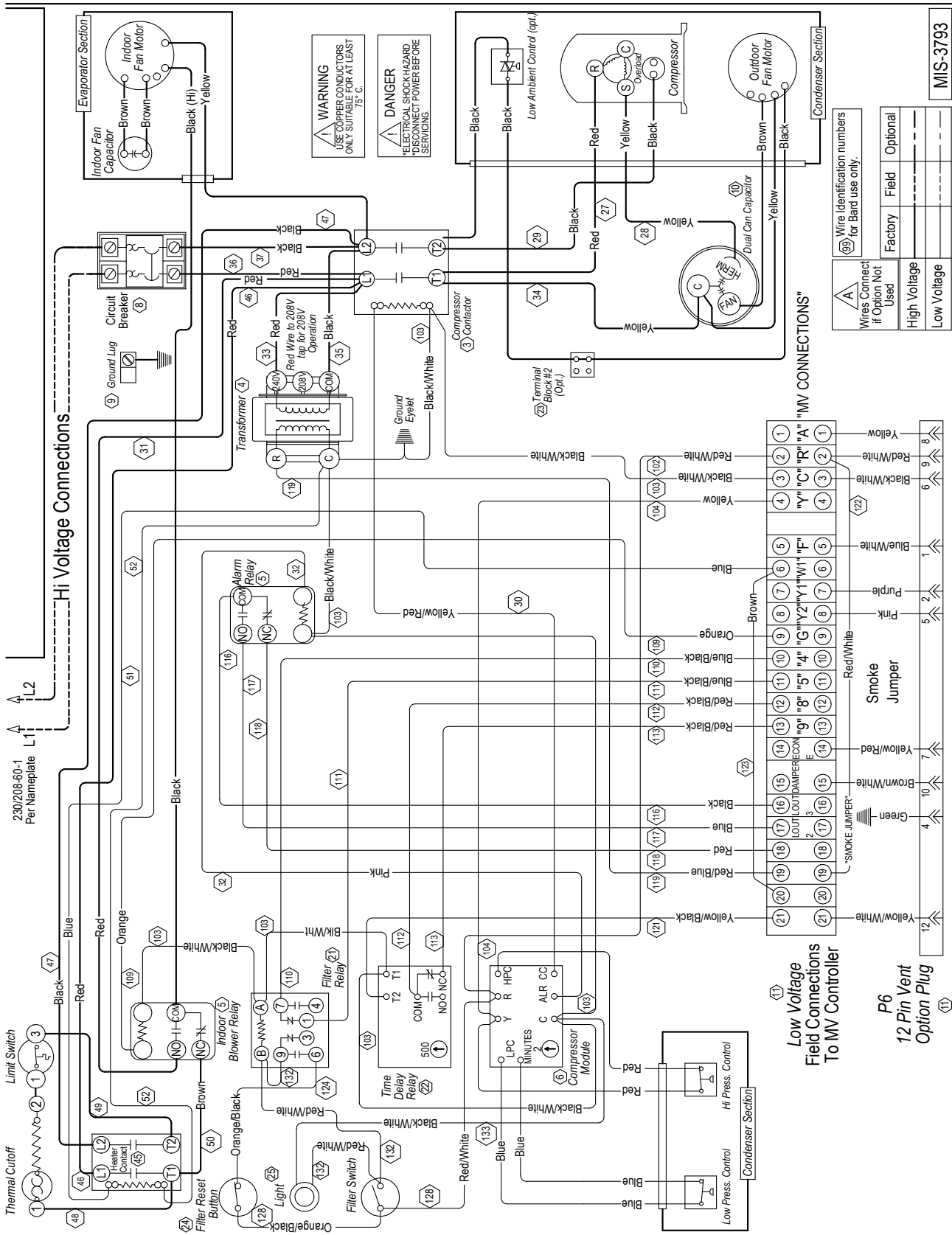

Wires Connect if Option Not Used

High Voltage	Low Voltage	Factory	Field	Optional

Wire Identification numbers for Bard use only.

MIS-3793

FIGURE 9B
H24,36*A Wiring Diagram – Top

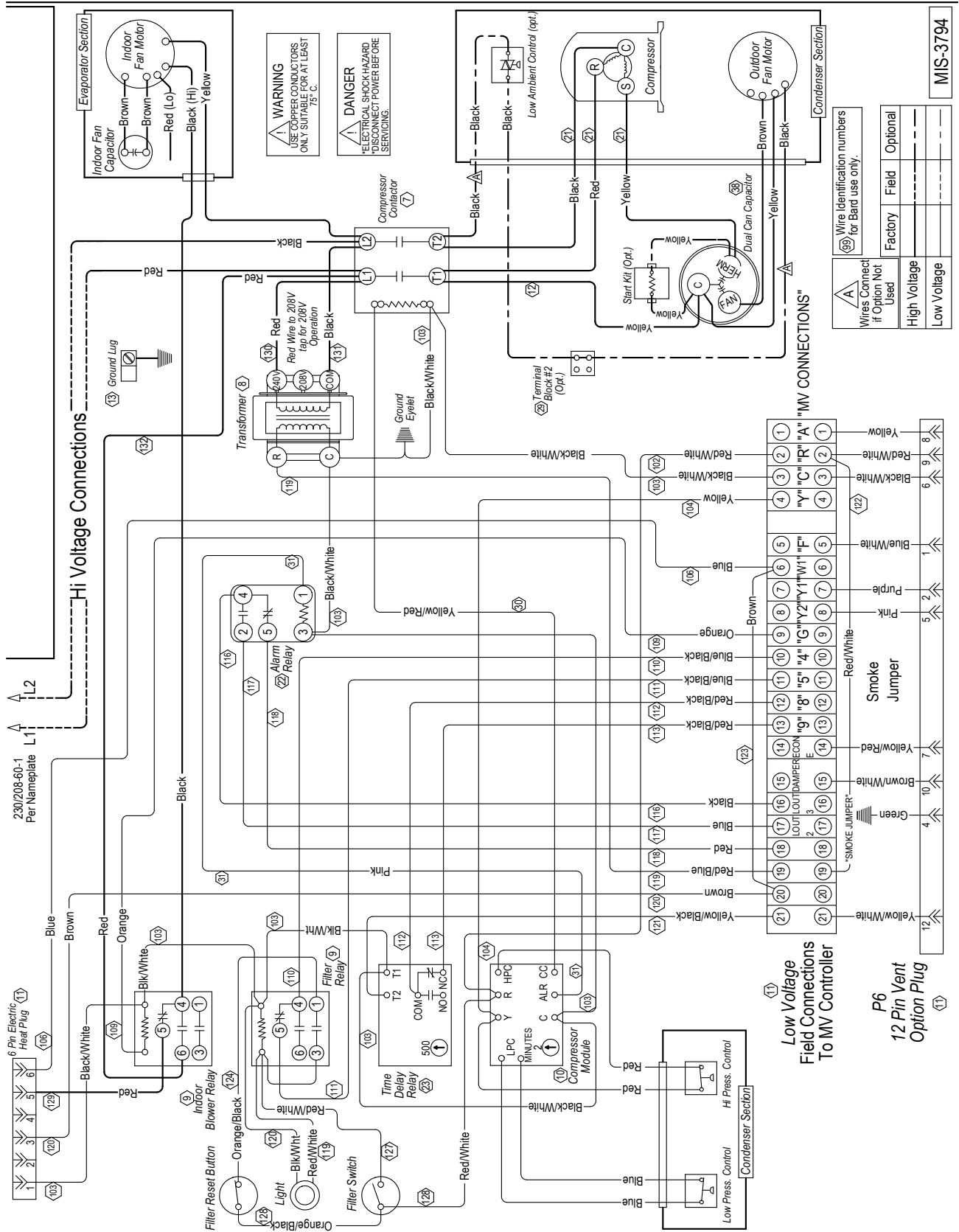
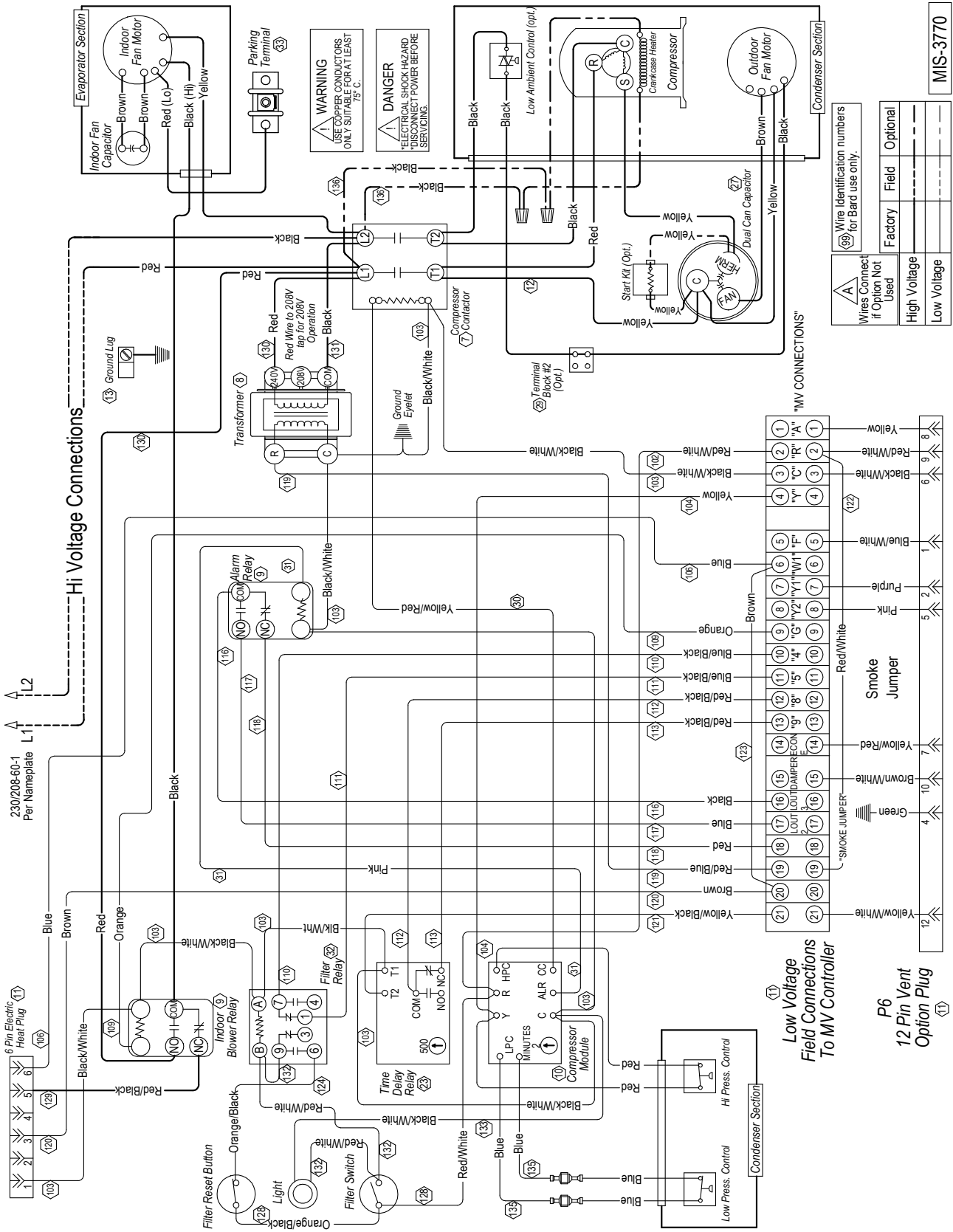

FIGURE 9C
H42,48,60*A Wiring Diagram – Top



WARNING
 USE COPPER CONDUCTORS
 ONLY SUITABLE FOR AT LEAST
 75° C.

DANGER
 ELECTRICAL SHOCK HAZARD
 DISCONNECT POWER BEFORE
 SERVICING.

Wire identification numbers for Bard use only.

High Voltage	Field	Optional

Wires Connect if Option Not Used

MIS-3770

FIGURE 9D
H72*A Wiring Diagram - Top

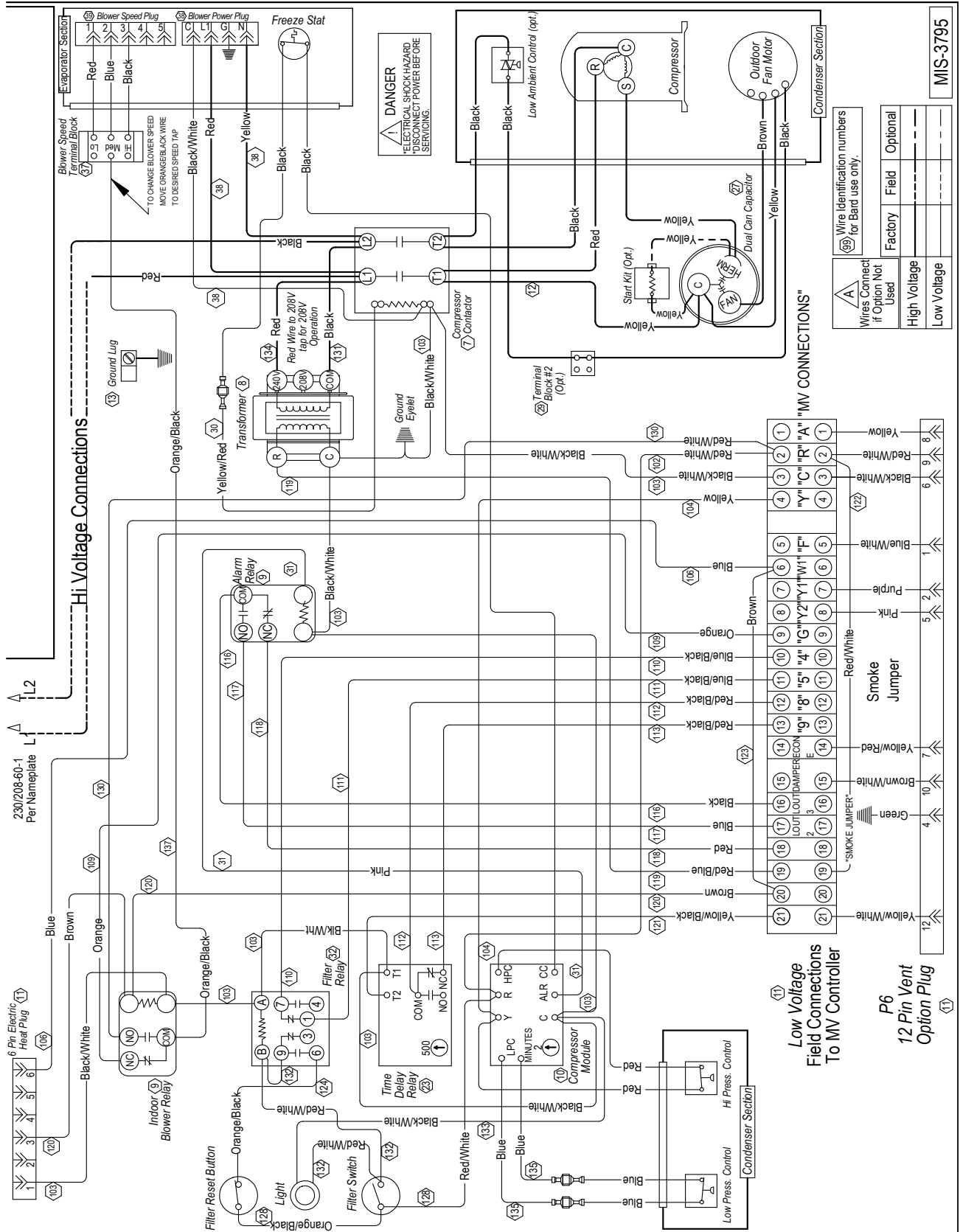

Wires Connect if Option Not Used

Wire Identification numbers	Factory	Field	Optional
(99) Wire identification numbers for Barc use only.			
A			
High Voltage			
Low Voltage			

MIS-3795

Low Voltage
Field Connections
To MV Controller

P6
12 Pin Vent
Option Plug

FIGURE 10
H*A Wiring Diagram – Bottom**

MIS-3710

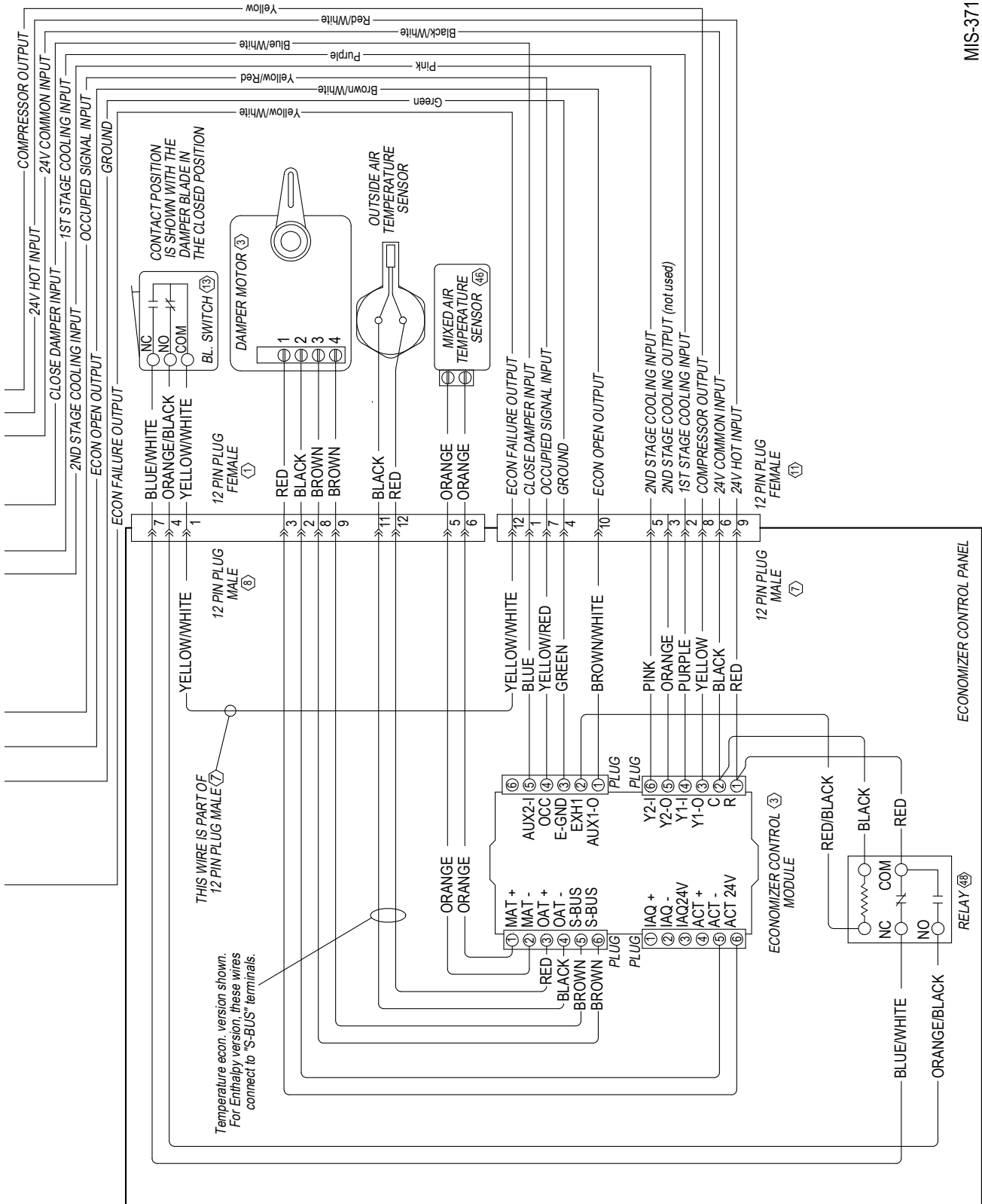
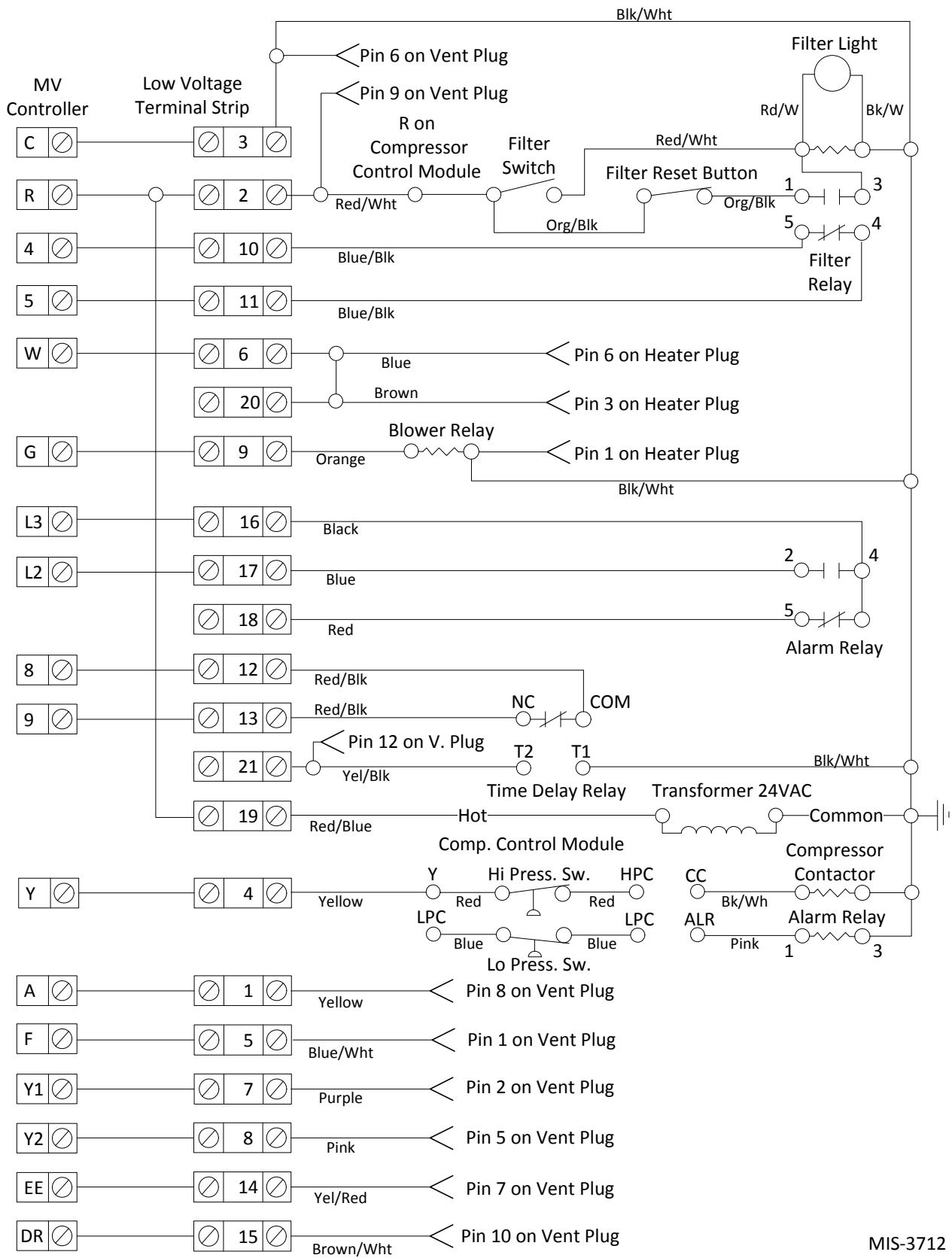

FIGURE 11
H*A Low Voltage Ladder Diagram for Unit and MV Connections**



MIS-3712