

---

**INSTALLATION  
INSTRUCTIONS**

**WALL MOUNTED PACKAGED  
AIR CONDITIONER**

**MODELS: WE252 WE301  
WE371 WE421  
WE482 WE602  
WE701**

---

**THESE MODELS ALL USE REFRIGERANT R-407C  
and ARE FOR 50HZ OPERATION.**

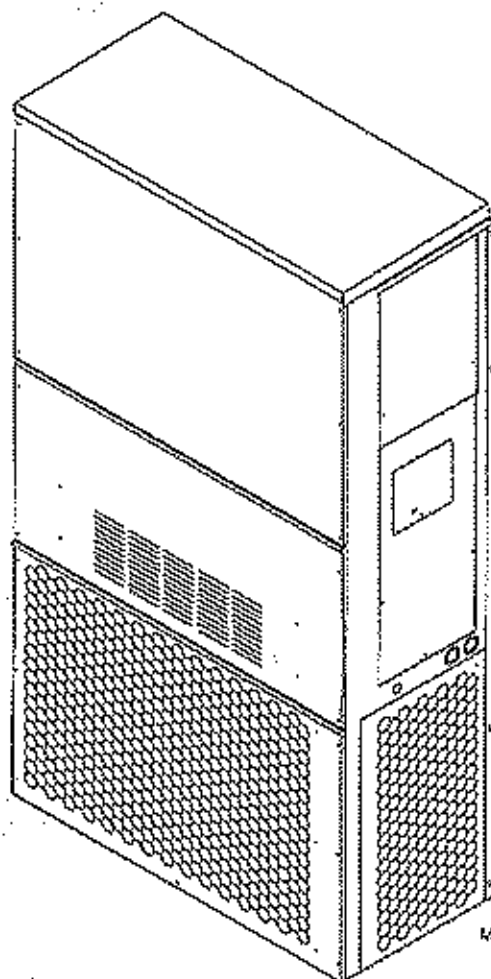

**CLIMATE CONTROL SOLUTIONS**

Bard Manufacturing Company  
Bryan, Ohio 43506

*Since 1914...Moving ahead, just as  
planned.*

Manual No.: 2100-385  
Supersedes:  
File: Volume III, Tab 16  
Date: 08-20-01

# CONTENTS

## Getting Other Information

### Wall Mount General Information

Model Nomenclature .....	2
Shipping Damage .....	5
General .....	5
Duct Work .....	5
Filters .....	6
Fresh Air Intake .....	6
Condensate Drain .....	6

### Installation Instructions

Wall Mounting Information .....	7
Mounting the Unit .....	7
Wiring – Main Power .....	12
Wiring – Low Voltage .....	12

## Figures

Figure 1 Unit Dimensions .....	3
Figure 2 Fresh Air Damper Assembly .....	6
Figure 3 Mounting Instructions .....	8
Figure 4 Electric Heat Clearance .....	9
Figure 5 Wall-Mounting Instructions .....	10
Figure 6 Wall-Mounting Instructions .....	10
Figure 7 Common Wall-Mounting Instructions .....	11
Figure 8 Low Voltage Wiring Diagram .....	13
Figure 9 Fan Blade Setting .....	16

## Start Up

Important Installer Note .....	14
High Pressure Switch .....	14
Service Hints .....	14
Sequence of Operations .....	14
Compressor Control Module .....	14
Adjustments .....	15
Phase Monitor .....	16
Pressure Service Ports .....	15

## Troubleshooting

Fan Blade Setting Dimensions .....	16
Removal of Fan Shroud .....	16
Refrigerant Charge .....	16
Cooling Pressures .....	18
Optional Accessories .....	19

## R-407C Refrigerant

Service Procedures & Considerations .....	20
Charging .....	20
Leaks .....	20

## Tables

Table 1 Electric Heat Table .....	2
Table 2 Electrical Specifications .....	3
Table 3 Thermostat Wire Size .....	12
Table 4 Wall Thermostat and Subbase Combinations .....	12
Table 5 Fan Blade Setting Dimension .....	16
Table 6 Suction Line Temperatures .....	18
Table 7 Rated CFM and ESP .....	18
Table 8 Indoor Blower Performance .....	17
Table 9 Maximum ESP of Operation – Electric Heat Only .....	17
Table 10 Cooling Pressures .....	18
Table 11 Optional Accessories .....	19
Table 12 R-407C Temperature/Pressure Chart .....	21

## GETTING OTHER INFORMATION AND PUBLICATIONS

These publications can help you install the air conditioner or heat pump. You can usually find these at your local library or purchase them directly from the publisher. Be sure to consult current edition of each standard.

National Electrical Code ..... ANSI/NFPA 70

Standard for the Installation ..... ANSI/NFPA 90A  
of Air Conditioning and  
Ventilating Systems

Standard for Warm Air ..... ANSI/NFPA 90B  
Heating and Air  
Conditioning Systems

Load Calculation for ..... ACCA Manual J  
Residential Winter and  
Summer Air Conditioning

Duct Design for Residential ..... ACCA Manual D  
Winter and Summer Air  
Conditioning and Equipment  
Selection

### FOR MORE INFORMATION, CONTACT THESE PUBLISHERS:

**ACCA** Air Conditioning Contractors of America  
1712 New Hampshire Avenue NW  
Washington, DC 20009  
Telephone: (202) 483-9370  
Fax: (202) 234-4721

**ANSI** American National Standards Institute  
11 West Street, 13th Floor  
New York, NY 10036  
Telephone: (212) 642-4900  
Fax: (212) 302-1286

**ASHRAE** American Society of Heating Refrigerating,  
and Air Conditioning Engineers, Inc.  
1791 Tullie Circle, N.E.  
Atlanta, GA 30329-2305  
Telephone: (404) 636-8400  
Fax: (404) 321-5478

**NFPA** National Fire Protection Association  
Batterymarch Park  
P.O. Box 9101  
Quincy, MA 02269-9901  
Telephone: (800) 344-3555  
Fax: (617) 984-7057

Manufactured under the following U.S. patent numbers:

5,485,878; 5,301,744; 5,002,116; 4,924,934;  
4,875,520; 4,825,936; 4,432,409

# WALL MOUNT GENERAL INFORMATION

## AIR CONDITIONER WALL MOUNT MODEL NOMENCLATURE

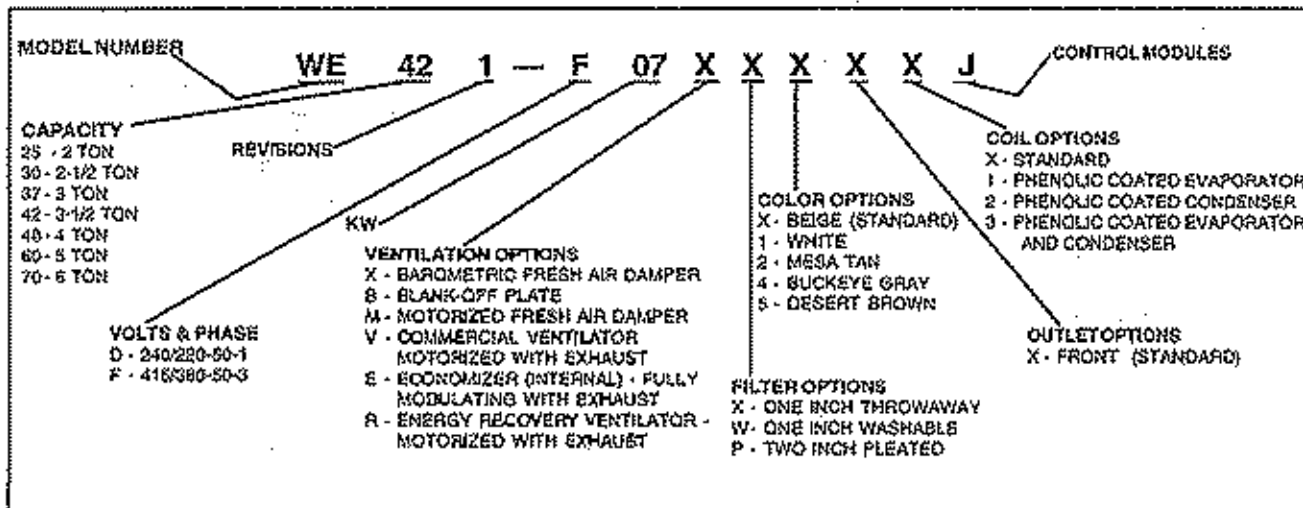

**TABLE 1  
ELECTRIC HEAT TABLE**

Models	WE252-D		WE252-F		WE301-D WE371-D		WE301-F WE371-F		WE421-F WE482-F WE602-F WE701-F	
	240V-1 WATTS	220V-1 WATTS	415V-3 WATTS	380V-3 WATTS	240V-1 WATTS	220V-1 WATTS	415V-3 WATTS	380V-3 WATTS	415V-3 WATTS	380V-3 WATTS
5.0	5011	4220	4484	3751	5011	4220				
7.0							6740	5656	6740	5660
8.0	8011	6721								
10.0					9994	8411				
12.0							11178	9408		
14.0									13450	11280

**TABLE 2  
ELECTRICAL SPECIFICATIONS**

Model	Rated Volts and Phase	Operating Voltage Range	Number Field Power Circuits	① Minimum Circuit Ampacity	② Maximum External Fuse or Circuit Breaker	③ Field Power Wire Size	④ Ground Wire Size
WE252-D0Z D05 D08	240/220-1	198 - 254	1	15	20	12	12
			1	27	30	10	10
			1	43	45	8	10
WE252-F0Z F05	415/380-3	342 - 456	1	7	15	14	14
			1	10	15	14	14
WE301-D0Z D05 D10	240/220-1	198 - 254	1	22	35	8	10
			1	29	35	8	10
			1	55	60	6	10
WE301-F0Z F07 F12	415/380-3	342 - 456	1	9	15	14	14
			1	15	15	14	14
			1	23	25	10	10
WE371-D0Z D05 D10	240/220-1	198 - 254	1	24	35	8	10
			1	29	35	8	10
			1	55	60	6	10
WE371-F0Z F07 F12	415/380-3	342 - 456	1	11	15	14	14
			1	16	20	12	12
			1	25	25	10	10
WE421-F0Z F07 F14	415/380-3	342 - 456	1	11	15	14	14
			1	16	20	12	12
			1	30	30	10	10
WE482-F0Z F07 F14	415/380-3	342 - 456	1	12	15	14	14
			1	16	20	12	12
			1	30	30	10	10
WE602-F0Z F07 F14	415/380-3	342 - 456	1	15	20	12	12
			1	16	20	12	12
			1	30	30	10	10
WE701-F0Z F07 F14	415/380-3	342 - 456	1	19	25	10	10
			1	19	25	10	10
			1	32	35	10	10

① Maximum size of the time delay fuse or HACR type circuit breaker for protection of field wiring conductors.

② Based on 75°C copper wire. All wiring must conform to NEC and all local codes.

③ These "Minimum Circuit Ampacity" values are to be used for sizing the field power conductors. Refer to the National Electric Code (latest revision), Article 310 for power conductor sizing.

*Caution: When more than one field power conductor circuit is run through one conduit, the conductors must be derated. Pay special attention to Note B of Table 310 regarding Ampacity Adjustment Factors when more than three (3) conductors are in a raceway.*

**IMPORTANT:** While this electrical data is presented as a guide, it is important to electrically connect properly sized fuses and conductor wires in accordance with all existing local codes.

FIGURE 1  
UNIT DIMENSIONS (IN INCHES)

Model	Width (W)	Depth (D)	Height (H)	Supply			Return			E	F	G	I	J	K	L	M	N	O	P	Q	R	S	T	U
				A	B	C	B	C	D																
WE252	33.3	17.125	70.563	7.88	19.88	11.88	19.88	35.0	18.5	25.75	20.56	26.75	28.06	29.25	27.0	2.63	34.13	22.05	10.55	4.19	12.0	5.0	12.0		
WE301 WE371	38.2	17.275	70.563	7.88	27.88	13.88	27.88	40.0	18.5	25.75	17.93	26.75	28.75	29.25	27.0	2.75	39.19	22.75	6.14	4.19	12.0	5.0	12.0		
WE421																									
WE482	42.075	22.432	84.875	9.88	29.88	15.88	29.88	43.88	19.10	31.68	30.0	32.68	28.94	34.69	32.43	3.37	42.88	23.88	10.0	1.44	16.0	1.88	16.0		
WE602																									
WE701	42.075	22.43	94.875	9.88	29.88	15.88	29.88	43.88	19.10	41.68	30.0	42.68	37.0	44.75	42.5	3.37	42.88	33.88	10.0	2.0	16.0	1.89	16.0		

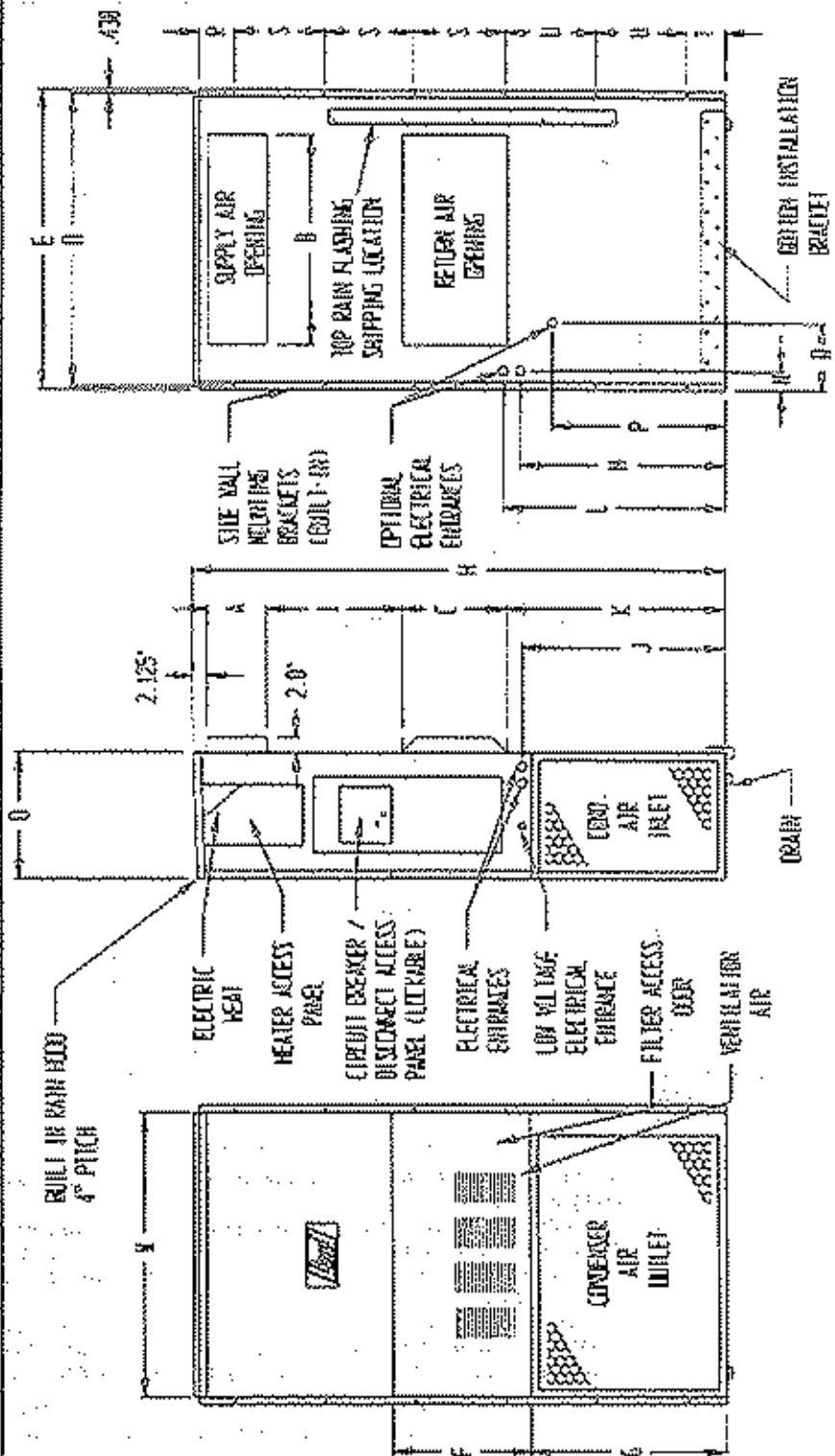

FRONT VIEW

SIDE VIEW

BACK VIEW

## SHIPPING DAMAGE

Upon receipt of equipment, the carton should be checked for external signs of shipping damage. If damage is found, the receiving party must contact the last carrier immediately, preferably in writing, requesting inspection by the carrier's agent.

## GENERAL

The equipment covered in this manual is to be installed by trained, experienced service and installation technicians.

The refrigerant system is completely assembled and charged. All internal wiring is complete.

The unit is designed for use with or without duct work. Flanges are provided for attaching the supply and return ducts.

These instructions explain the recommended method to install the air cooled self-contained unit and the electrical wiring connections to the unit.

These instructions and any instructions packaged with any separate equipment required to make up the entire air conditioning system should be carefully read before beginning the installation. Note particularly "Starting Procedure" and any tags and/or labels attached to the equipment.

While these instructions are intended as a general recommended guide, they do not supersede any national and/or local codes in any way. Authorities having jurisdiction should be consulted before the installation is made. See Page 1 for information on codes and standards.

Size of unit for a proposed installation should be based on heat loss calculation made according to methods of Air Conditioning Contractors of America (ACCA). The air duct should be installed in accordance with the Standards of the National Fire Protection Association for the Installation of Air Conditioning and Ventilating Systems of Other Than Residence Type, NFPA No. 90A, and Residence Type Warm Air Heating and Air Conditioning Systems, NFPA No. 90B. Where local regulations are at a variance with instructions, installer should adhere to local codes.

## DUCT WORK

All duct work, supply and return, must be properly sized for the design air flow requirement of the equipment. Air Conditioning Contractors of America (ACCA) is an excellent guide to proper sizing. All duct work or portions thereof not in the conditioned space should be properly insulated in order to both conserve energy and prevent condensation or moisture damage.

Refer to Table 9 for maximum static pressure available for duct design.

Design the duct work according to methods given by the Air Conditioning Contractors of America (ACCA). When duct runs through unheated spaces, it should be insulated with a minimum of one inch of insulation. Use insulation with a vapor barrier on the outside of the insulation. Flexible joints should be used to connect the duct work to the equipment in order to keep the noise transmission to a minimum.

A 1/4 inch clearance to combustible material for the first 3 feet of duct attached to the outlet air frame is required. See Wall Mounting Instructions and Figures 3 and 4 for further details.

Ducts through the walls must be insulated and all joints taped or sealed to prevent air or moisture entering the wall cavity.

Some installations may not require any return air duct. A metallic return air grille is required with installations not requiring a return air duct. The spacing between louvers on the grille shall not be larger than 5/8 inches.

Any grille that meets the 5/8 inch louver criteria may be used. It is recommended that Bard Return Air Grille Kit RG-2 thru RG-5 or RFG-2 thru RFG-5 be installed when no return duct is used. Contact distributor or factory for ordering information. If using a return air filter grille, filters must be of sufficient size to allow a maximum velocity of 400 fpm.

*NOTE: If no return air duct is used, applicable installation codes may limit this cabinet to installation only in a single story structure.*

## FILTERS

A 1 inch throwaway filter is supplied with each unit. The filter slides into position making it easy to service. This filter can be serviced from the outside by removing the service door. A 1 inch washable filter and 2 inch pleated filter are also available as optional accessories. The internal filter brackets are adjustable to accommodate the 2 inch filter by bending the metal tabs holding the 1 inch filter down. There are two tabs on each side of the filter.

## FRESH AIR INTAKE

All units are built with fresh air inlet slots punched in the service panel.

If the unit is equipped with the fresh air damper assembly, the assembly is shipped already attached to the unit. The damper blade is locked in the closed

position. To allow the damper to operate, the maximum and minimum blade position stops must be installed. See Figure 2.

Capacity and efficiency is based upon the fresh air blank-off plate in place and is recommended for maximum energy efficiency.

The blank-off plate is available upon request from the factory and is installed in place of the fresh air damper shipped with each unit.

## CONDENSATE DRAIN

A plastic drain hose extends from the drain pan at the top of the unit down to the unit base. There are openings in the unit base for the drain hose to pass through. In the event the drain hose is connected to a drain system of some type, it must be an open or vented type system to assure proper drainage.

FIGURE 2  
FRESH AIR DAMPER ASSEMBLY

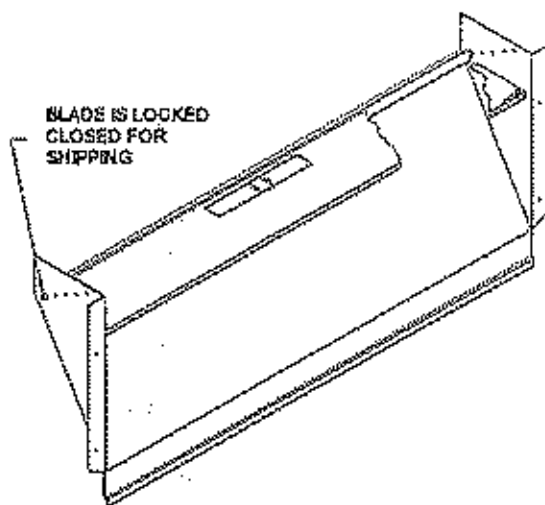

MIS-839



# INSTALLATION INSTRUCTIONS

## WALL MOUNTING INFORMATION

1. Two holes for the supply and return air openings must be cut through the wall as shown in Figure 3.
2. On wood-frame walls, the wall construction must be strong and rigid enough to carry the weight of the unit without transmitting any unit vibration.
3. Concrete block walls must be thoroughly inspected to insure that they are capable of carrying the weight of the installed unit.

## PROPER UNIT PLACEMENT

Refer to Technical Bulletin TB01-4 "Wall Mount Equipment Clearance for Proper Operation". This bulletin will provide information concerning the placement of units as to clearance between dual unit installation (mounted on common wall) of units discharging against a wall or essentially solid barrier, and units discharging against opposing (facing) units.

## MOUNTING THE UNIT

1. These units are secured by wall mounting brackets which secure the unit to the outside wall surface at both sides. A bottom mounting bracket is provided for ease of installation, but is not required.
2. The unit itself is suitable for 0 inch clearance, but the supply air duct flange and the first 3 feet of supply air duct require a minimum of 1/4 inch clearance to combustible material. However it is highly recommended that a 1 inch clearance is used for ease of installation and maintaining the required clearance to combustible material. See Figures 3 and 4 for details.
3. Locate and mark lag bolt locations and bottom bracket location, if desired. See Figure 3.
4. Mount bottom mounting bracket, if used.
5. Hook top rain flashing under back bend of top. Top rain flashing is shipped secured to the right side of the back.
6. Position unit in opening and secure with 5/16 lag bolts; use 7/8 inch diameter flat washers on the lag bolts.
7. Secure rain flashing to wall and caulk across entire length of top. See Figure 3.
8. For additional mounting rigidity, the return air and supply air frames or collars can be drilled and screwed or welded to the structural wall itself (depending upon wall construction). Be sure to observe required clearance if combustible wall.
9. On side by side installations, maintain a minimum of 20 inches clearance on right side to allow access to control panel and heat strips, and to allow proper airflow to the outdoor coil. Additional clearance may be required to meet local or national codes.



## WARNING

Failure to provide the 1/4 inch clearance between the supply duct and a combustible surface for the first 3 feet of duct can result in fire causing damage, injury or death.

**FIGURE 3  
MOUNTING INSTRUCTIONS**

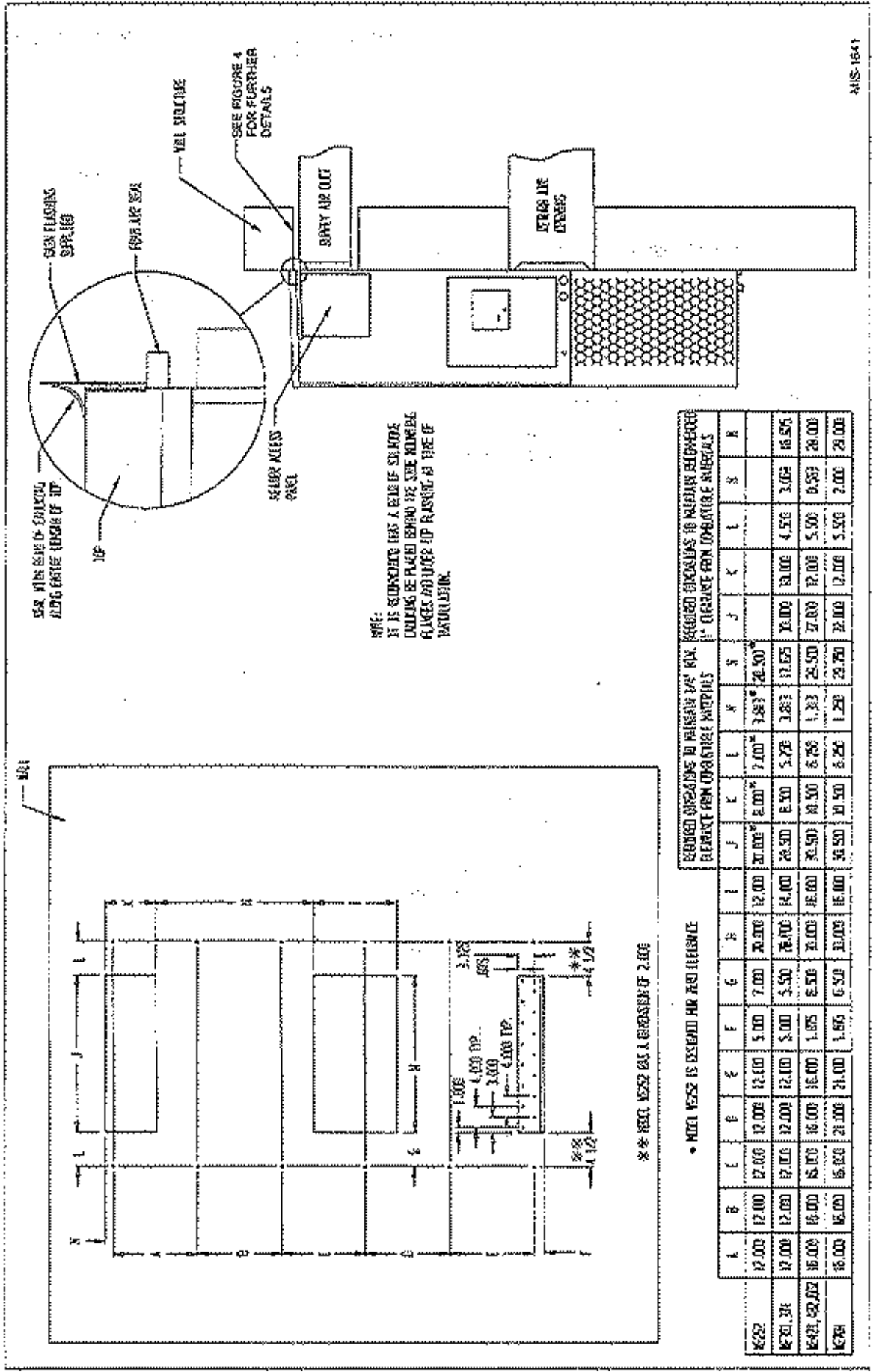

AMS-1641

**FIGURE 4  
ELECTRIC HEAT CLEARANCE**

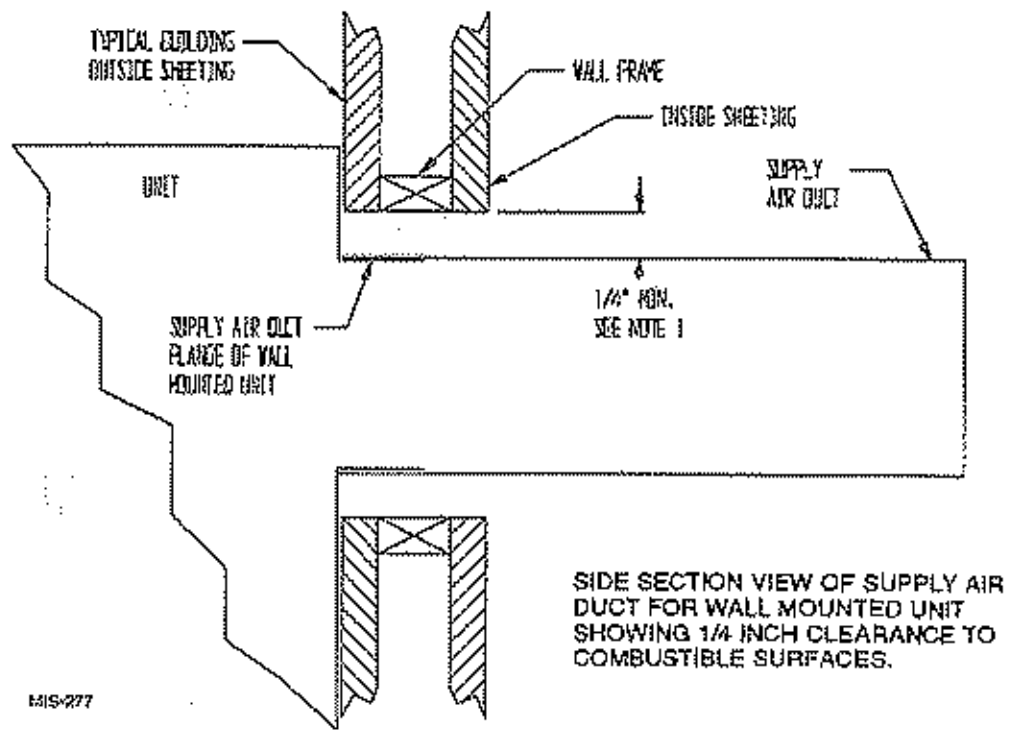

MIS-277

**NOTE:** *A 1/4 inch clearance to combustible material for the first 3 feet of duct attached to the outlet air frame is required. However it is highly recommended that a 1 inch clearance is used for ease of installation and maintaining the required clearance to combustible material*

*This requirement does not apply to Model WE252 as it is approved for 0 inch clearance of duct work.*

 <b>WARNING</b>
<p>A <i>minimum</i> of 1/4 inch clearance must be maintained between the supply air duct and combustible materials. This is required for the first 3 feet of ducting.</p> <p>It is important to insure that the 1/4 inch minimum spacing is maintained at all points.</p> <p>Failure to do this could result in overheating the combustible material and may result in a fire causing damage, injury or death.</p>

## FIGURE 5 WALL-MOUNTING INSTRUCTIONS

SEE FIGURE 3 - MOUNTING INSTRUCTIONS

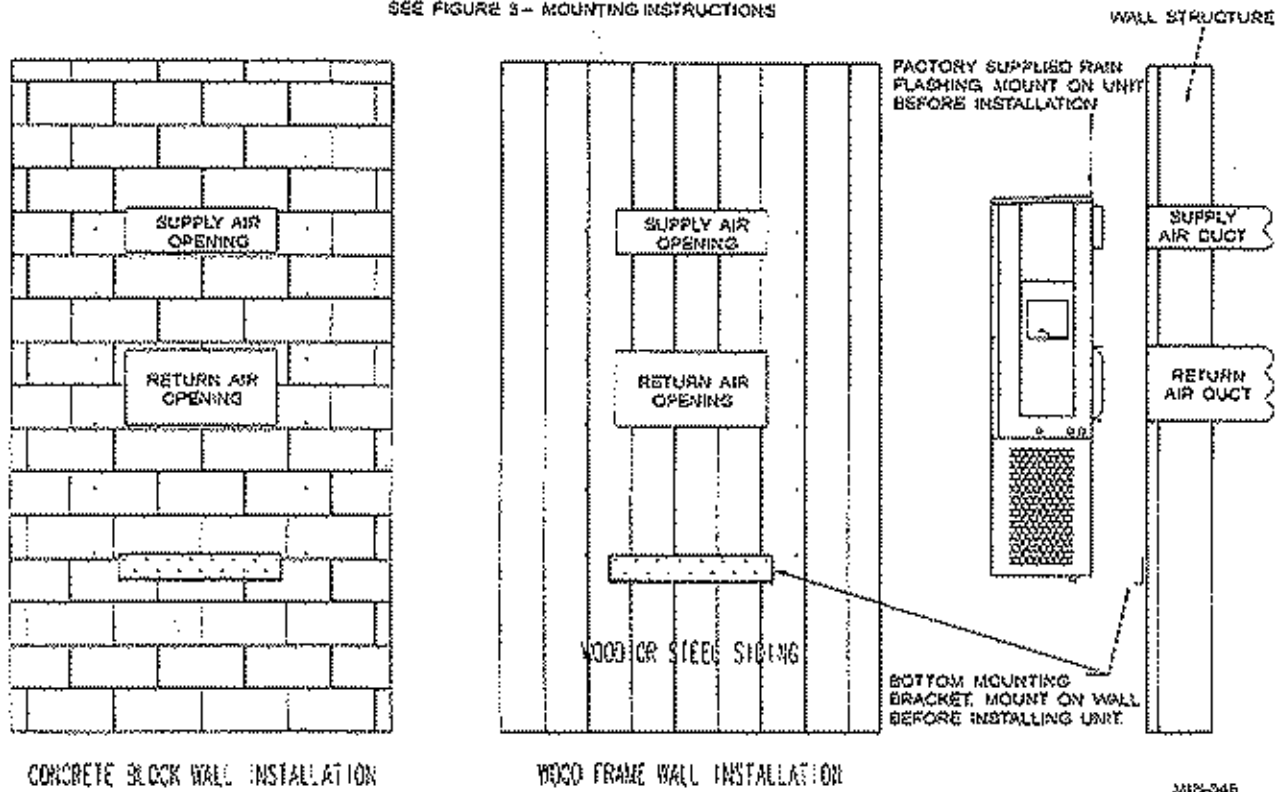

## FIGURE 6 WALL-MOUNTING INSTRUCTIONS

SEE UNIT DIMENSIONS FIGURE 1  
FOR ACTUAL DIMENSIONS

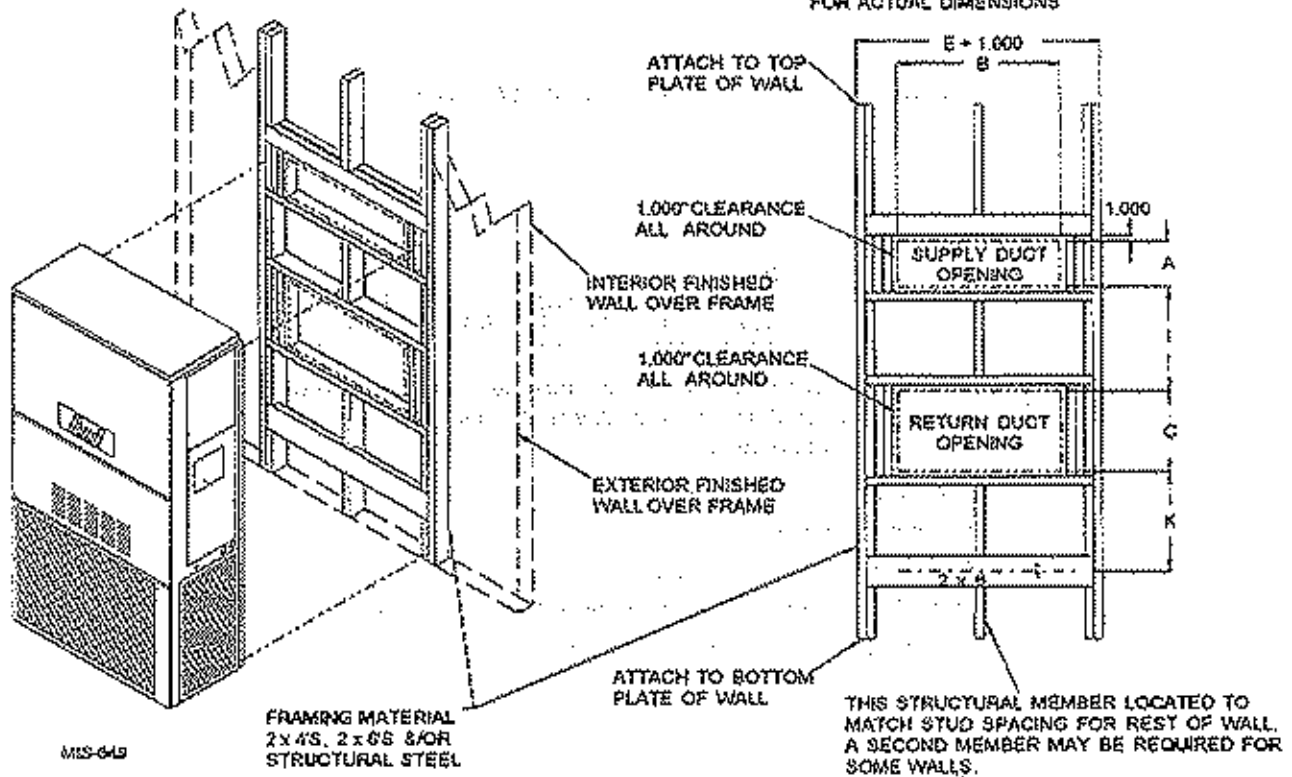

**FIGURE 7  
COMMON WALL-MOUNTING INSTALLATIONS**

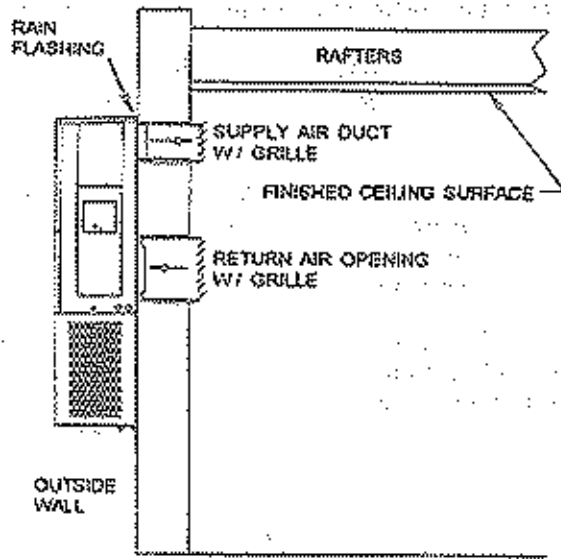

FREE AIR FLOW  
NO DUCT

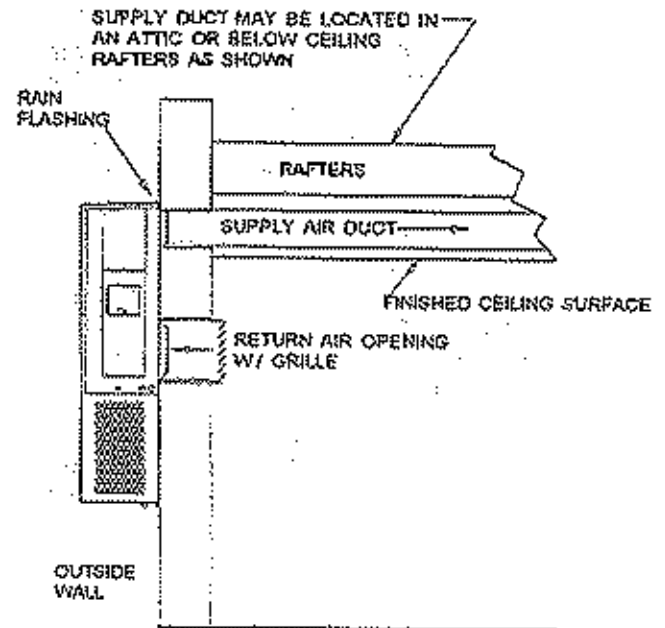

DUCTED SUPPLY  
RETURN AT UNIT

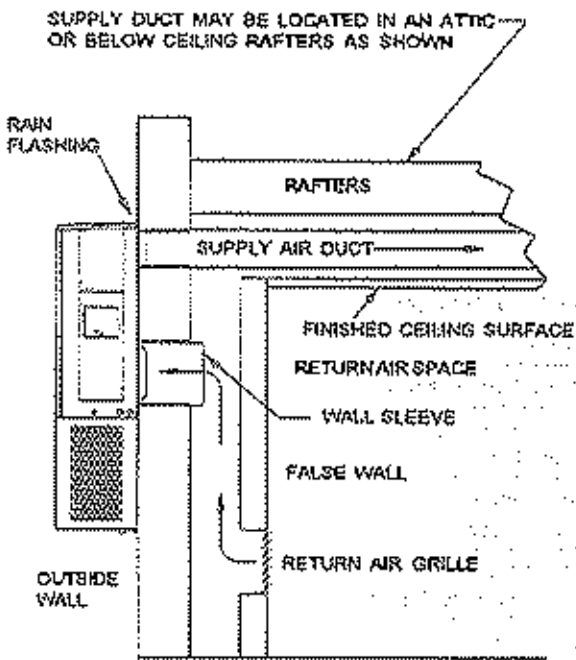

FALSE WALL INSTALLATION

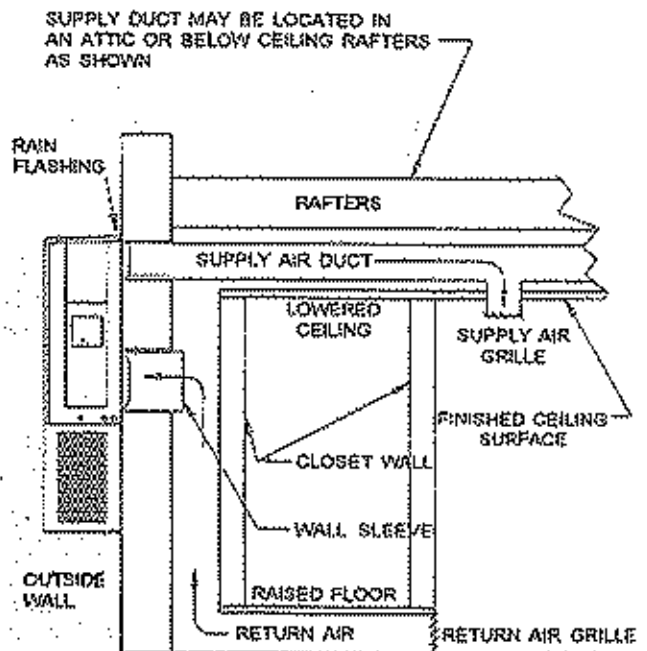

CLOSET INSTALLATION

MIS-650

## WIRING — MAIN POWER

Refer to the unit rating plate for wire sizing information and maximum fuse or "HACR" type circuit breaker size. Each outdoor unit is marked with a "Maximum Circuit Ampacity". This means that the field wiring used must be sized to carry that amount of current. Depending on the installed KW of electric heat, there may be two field power circuits required. If this is the case, the unit serial plate will so indicate. All models are suitable only for connection with copper wire. Each unit and/or wiring diagram will be marked "Use Copper Conductors Only". These instructions *must* be adhered to. Refer to the National Electrical Code (NEC) for complete current carrying capacity data on the various insulation grades of wiring material. All wiring must conform to NEC and all local codes.

The electrical data lists fuse and wire sizes (75° C copper) for all models, including the most commonly used heater sizes. Also shown are the number of field power circuits required for the various models with heaters.

The unit rating plate lists a "Maximum Time Delay Relay Fuse" or "HACR" type circuit breaker that is to be used with the equipment. The correct size must be used for proper circuit protection and also to assure that there will be no nuisance tripping due to the momentary high starting current of the compressor motor.

The disconnect access door on this unit may be locked to prevent unauthorized access to the disconnect. To convert for the locking capability, bend the tab, located in the bottom left hand corner of the disconnect opening under the disconnect access panel, straight out. This tab will now line up with the slot in the door. When shut, a padlock may be placed through the hole in the tab preventing entry.

## WIRING — LOW VOLTAGE WIRING

230/208V — 1 phase and 3 phase equipment dual primary voltage transformers. All equipment leaves the factory wired on 240V tap. For 208V operation, reconnect from 240V to 208V tap. The acceptable operating voltage range for the 240V and 208V taps are:

TAP	RANGE
240	253 – 216
208	220 – 187

*NOTE: The voltage should be measured at the field power connection point in the unit and while the unit is operating at full load (maximum amperage operating condition).*

Five (5) wires should be run from thermostat subbase to the 24V terminal board in the unit. A five conductor, 18 gauge copper, color-coded thermostat cable is recommended. The connection points are shown in Figure 8.

TABLE 3  
THERMOSTAT WIRE SIZE

Transformer VA	FLA	Wire Gauge	Maximum Distance in Feet
55	2.3	20 Gauge	45
		18 Gauge	60
		16 Gauge	100
		14 Gauge	160
		12 Gauge	250

TABLE 4  
WALL THERMOSTAT AND SUBBASE COMBINATIONS

Thermostat	Subbase	Predominate Features
8403-002 T87F3111	8404-003 Q539A1220	1 stage heat, 1 stage cool System: heat-off-cool Fan: auto-on
8403-041 T8034C	---	1 stage heat, 1 stage cool System: heat-off-cool Fan: auto-on
8403-019 T874C1780	8404-012 Q674A1001	1 stage cool, 2 stage heat System: heat-auto-cool Fan: auto-on
8403-021 T874D1934	8404-012 Q674A1001	2 stage cool, 2 stage heat System: heat-auto-cool Fan: auto-on
8403-035 1F95-80	---	2 stage cool, 2 stage heat Electronic 7 day programming
8403-043 CM-200	---	1 stage heat, 1 stage cool System: heat-off-cool Fan: auto-on

**FIGURE 8  
LOW VOLTAGE WIRING DIAGRAM**

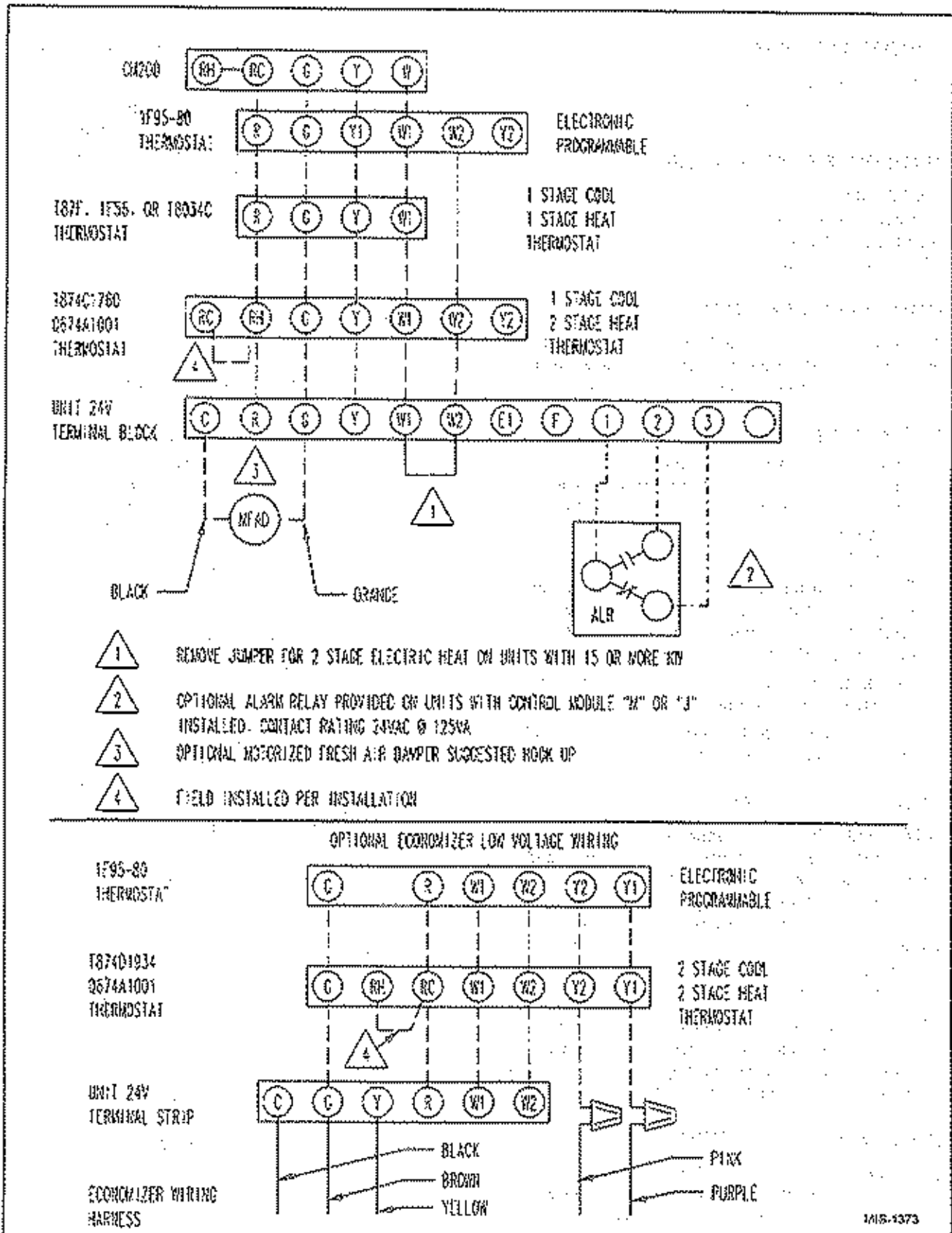

# START UP

---

## IMPORTANT INSTALLER NOTE

For improved start-up performance, wash the indoor coil with a dish washing detergent.

## HIGH PRESSURE SWITCH

The WE482, WE602 and WE701 models are supplied with a remote reset high pressure switch. If tripped, this pressure switch may be reset by turning the thermostat off then back on again.

## CONDENSER FAN OPERATION

The condenser fan motor on 230/208 volt, one and three phase 50 Hz models must have fan motor wired on low speed. These models are factory wired on low speed.

## SERVICE HINTS

1. Caution homeowner to maintain clean air filters at all times. Also, not to needlessly close off supply and return air registers. This reduces air flow through the system, which shortens equipment service life as well as increasing operating costs.
2. Switching to heating cycle at 75° F or higher outside temperature may cause a nuisance trip of the remote reset high pressure switch. Turn thermostat off then on to reset the high pressure switch.
3. Check all power fuses or circuit breakers to be sure they are the correct rating.
4. Periodic cleaning of the outdoor coil to permit full and unrestricted airflow circulation is essential.

## SEQUENCE OF OPERATION

**COOLING** – Circuit R-Y makes at thermostat pulling in compressor contactor, starting the compressor and outdoor motor. The G (indoor motor) circuit is automatically completed on any call for cooling operation or can be energized by manual fan switch on subbase for constant air circulation. On all 230 volt units there is a one minute off delay on the blower motor. 460 volt models do not have an off delay.

**HEATING** – Circuit R-W1 make at the thermostat pulling in heat contact for the strip heat and blower operation. On a call for second stage heat, R-W2 makes bringing on second heat contactor, if so equipped.

## COMPRESSOR CONTROL MODULE

The compressor control module is standard on all models covered by this manual. The compressor control is an anti-short cycle/lockout timer with high and low pressure switch monitoring and alarm relay output.

## Adjustable Delay On Make And Break Timer

On initial power up or any time power is interrupted to the unit the *delay on make* period begins which will be 2 minutes plus 10% of the *delay on break* setting. When the delay on make is complete and the high pressure switch (and low pressure switch, if employed) is closed, the compressor contactor is energized. Upon shutdown the delay on break timer starts and prevents restart until the delay on break and delay on make periods have expired.

During routine operation of the unit with no power interruptions the compressor will operate on demand with no delay.

## High Pressure Switch and Lockout Sequence

If the high pressure switch opens, the compressor contactor will de-energize immediately. The lockout timer will go into a *soft lockout* and stay in soft lockout until the high pressure switch closes *and* the delay on break time has expired. If the high pressure switch opens again in this same operating cycle the unit will go into *manual lockout* condition and the alarm relay circuit will energize. Recycling the wall thermostat resets the manual lockout.

## Low Pressure Switch, Bypass, and Lockout Sequence (OPTIONAL)

If the low pressure switch opens for more than 120 seconds, the compressor contactor will de-energize and go into a soft lockout. Regardless the state of the low pressure switch, the contactor will reenergize after the delay on make time delay has expired. If the low pressure switch remains open, or opens again for longer than 120 seconds the unit will go into manual lockout condition and the alarm relay circuit will energize. Recycling the wall thermostat resets the manual lockout.

## Alarm Relay Output

Alarm terminal is output connection for applications where alarm relay is employed. This terminal is powered whenever compressor is locked out due to HPC or LPC sequences as described.

*NOTE: Both high and low pressure switch controls are inherently automatic reset devices. The high pressure switch and low pressure switch cut out and cut in settings are fixed by specific air conditioner unit model. The lockout features, both soft and manual, are a function of the Compressor Control Module.*



## ADJUSTMENTS

### Adjustable Delay on Make and Delay on Break Timer

The potentiometer is used to select Delay on Break time from 30 seconds to 5 minutes. Delay on Make (DOM) timing on power-up and after power interruptions is equal to 2 minutes plus 10% of Delay on Break (DOB) setting:

0.5 minute (30 seconds)	DOB = 123 second	DOM
1.0 minute (60 seconds)	DOB = 126 second	DOM
2.0 minute (120 seconds)	DOB = 132 second	DOM
3.0 minute (180 seconds)	DOB = 138 second	DOM
4.0 minute (240 seconds)	DOB = 144 second	DOM
5.0 minute (300 seconds)	DOB = 150 second	DOM

During routine operation of the unit with no power interruptions the compressor will operate on demand with no delay.

### Typical Settings for Dual Unit Installation:

Unit 1: DOB set at 2 minutes, and DOM is 132 seconds

Unit 2: DOB set at 4 minutes, and DOM is 144 seconds

## PHASE MONITOR

All units with three phase compressors are equipped with a 3 phase line monitor to prevent compressor damage due to phase reversal.

The phase monitor in this unit is equipped with two LEDs. If the Y signal is present at the phase monitor and phases are correct the green LED will light.

If phases are reversed, the red fault LED will be lit and compressor operation is inhibited.

If a fault condition occurs, reverse two of the supply leads to the unit. Do not reverse any of the unit factory wires as damage may occur.

## PRESSURE SERVICE PORTS

Liquid and suction pressure service ports are installed on all units so that the system operating pressures can be observed. Pressure tables can be found later in the manual covering all models. It is imperative to match the correct pressure table to the unit by model number.

# TROUBLESHOOTING

## FAN BLADE SETTING DIMENSIONS

Shown in Figure 9 is the proper method to measure the fan blade location.

Any service work requiring removal or adjustment in the fan and/or motor area will require that the fan blade location be checked.

**FIGURE 9  
FAN BLADE SETTING**

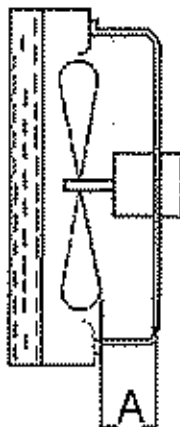

**TABLE 5  
FAN BLADE DIMENSIONS**

Model	Dimension A
WE252	1.0
WE301 WE371	1.25
WE421 WE482 WE802	1.75
WE701	1.25

## REMOVAL OF FAN SHROUD

1. Disconnect all power to unit.
2. Remove the screws holding both grilles – one on each side of unit – and remove grilles.
3. Remove screws holding fan shroud to condenser and bottom – 9 screws.
4. Unwire condenser fan motor.
5. Slide complete motor, fan blade, and shroud assembly out the left side of the unit.
6. Service motor/fan as needed.
7. Reverse steps to reinstall.

## REFRIGERANT CHARGE

The system is charged with R-407C. The correct quantity is shown on the unit rating plate. Optimum unit performance will occur with a refrigerant charge resulting in a suction line temperature (6 inches from compressor) as shown in Table 6.

The suction line temperatures shown in Table 6 are based upon 80°F dry bulb / 67°F wet bulb (50 percent R.H.) temperature and rated airflow across the evaporator coil during cooling cycle.

See page 20 for instructions in servicing units which contain refrigerant R-407C

**TABLE 6  
SUCTION LINE TEMPERATURES**

Model	Rated Airflow	95° F OD Temp.	82° F OD Temp.
WE252	675	58 - 60	65 - 67
WE301	950	64 - 66	66 - 68
WE371	1000	57 - 59	58 - 60
WE421	1150	55 - 57	68 - 70
WE482	1275	57 - 59	69 - 71
WE602	1400	58 - 60	63 - 65
WE701	1485	61 - 63	60 - 62

**TABLE 7  
RATED CFM and ESP**

Model	Rated CFM	Rated ESP	Recommended Airflow Range
WE252	675	.22	610 - 750
WE301	950	.22	855 - 1045
WE371	1000	.20	900 - 1100
WE421	1165	.30	1050 - 1260
WE482	1275	.20	1150 - 1400
WE802	1400	.30	1260 - 1540
WE701	1485	.20	1340 - 1630

RATED CFM AND RATED ESP WITH BLOWER SET ON HIGH SPEED.

**TABLE 8  
INDOOR BLOWER PERFORMANCE  
CFM (m<sup>3</sup>/s) at 220V**

ESP in Inches H <sub>2</sub> O (Pa)	WE25	WE30, WE37		WE42, WE48		WE60, WE70	
	Dry / Wet Coil	High Speed	Low Speed	High Speed	Low Speed	High Speed	Low Speed
		Dry / Wet Coil	Dry / Wet Coil	Dry / Wet Coil	Dry / Wet Coil	Dry / Wet Coil	Dry / Wet Coil
.00 (0)	800 / 845 (0.36 / 0.40)	1160 / 1095 (0.55 / 0.52)	790 / 780 (0.37 / 0.37)	1565 / 1500 (0.74 / 0.71)	1370 / 1330 (0.65 / 0.63)	1825 / 1660 (0.86 / 0.78)	1330 / 1200 (0.63 / 0.57)
.10 (25)	830 / 780 (0.39 / 0.37)	1115 / 1060 (0.53 / 0.50)	775 / 760 (0.36 / 0.35)	1470 / 1380 (0.69 / 0.65)	1285 / 1240 (0.61 / 0.59)	1740 / 1570 (0.82 / 0.74)	--/--
.20 (50)	780 / 720 (0.37 / 0.34)	1070 / 1000 (0.50 / 0.47)	760 / 740 (0.35 / 0.35)	1360 / 1285 (0.64 / 0.61)	1200 / 1160 (0.57 / 0.55)	1660 / 100 (0.78 / 0.71)	--/--
.30 (75)	710 / 640 (0.33 / 0.30)	1000 / 915 (0.47 / 0.43)	--/--	1250 / 1160 (0.59 / 0.55)	1120 / 1080 (0.53 / 0.51)	1550 / 1400 (0.73 / 0.66)	--/--
.40 (100)	640 / 560 (0.30 / 0.26)	925 / 830 (0.44 / 0.39)	--/--	1140 / 1065 (0.54 / 0.50)	--/--	1470 / 1330 (0.69 / 0.63)	--/--

Above data is with 1 inch (25mm) standard disposable filter and 1 inch (25mm) washable filter.  
For optional 2 inch (51mm) pleated filter reduce ESP by .15 inches (37.33 Pa).

**TABLE 9  
MAXIMUM ESP OF OPERATION  
ELECTRIC HEAT ONLY**

MODEL	HIGH SPEED ESP	LOW SPEED ESP
WE252-D05	.40	---
WE252-D08	.40	---
WE252-F05	.40	---
WE301, WE371-D05	.40	.40
WE301, WE371-D10	.40	.35
WE301, WE371-F07	.40	.30
WE301, WE371-F12	.35	.25
WE421, WE482-F07	.40	.40
WE602, WE701-F07	.40	.40
WE421, WE482-F12	.40	.40
WE602, WE701-F12	.40	.40

**TABLE 10  
PRESSURE TABLE**

**COOLING**

**AIR TEMPERATURE ENTERING**

Model	Return Air Temperature	Pressure	OUTDOOR COIL								
			75°	80°	85°	90°	95°	100°	105°	110°	115°
WE252	75° DB 62° WB	Low Side	71	73	74	76	77	78	79	81	82
		High Side	215	232	251	269	290	311	332	356	379
	80° DB 67° WB	Low Side	76	78	79	81	82	84	85	87	88
		High Side	220	238	257	276	297	319	341	365	389
	85° DB 72° WB	Low Side	79	81	82	84	85	87	88	90	91
		High Side	228	246	266	286	307	330	353	378	403
WE301	75° DB 62° WB	Low Side	78	79	81	83	85	86	88	89	90
		High Side	227	246	262	280	299	318	338	359	379
	80° DB 67° WB	Low Side	83	85	87	89	91	92	94	95	96
		High Side	233	251	269	287	307	326	347	368	389
	85° DB 72° WB	Low Side	86	88	90	92	94	95	97	98	99
		High Side	241	260	278	297	318	337	359	381	403
WE371	75° DB 62° WB	Low Side	79	81	82	84	85	87	88	90	91
		High Side	224	241	258	277	295	315	335	357	378
	80° DB 67° WB	Low Side	85	87	88	90	91	93	94	96	97
		High Side	230	247	265	284	303	323	344	366	388
	85° DB 72° WB	Low Side	88	90	91	93	94	96	97	99	100
		High Side	238	256	274	294	314	334	356	379	402
WE421	75° DB 62° WB	Low Side	78	80	83	85	88	90	93	94	96
		High Side	235	251	267	284	301	319	336	355	373
	80° DB 67° WB	Low Side	83	86	89	91	94	96	99	101	103
		High Side	241	257	274	291	309	327	345	364	383
	85° DB 72° WB	Low Side	86	89	92	94	97	99	102	105	107
		High Side	249	266	284	301	320	338	357	377	396
WE482	75° DB 62° WB	Low Side	83	85	86	88	89	91	92	94	94
		High Side	228	249	269	289	308	328	348	368	388
	80° DB 67° WB	Low Side	89	91	92	94	95	97	98	100	101
		High Side	234	255	276	296	316	336	357	377	396
	85° DB 72° WB	Low Side	92	94	95	97	98	100	101	104	105
		High Side	242	264	286	306	327	348	369	390	410
WE602	75° DB 62° WB	Low Side	81	83	84	85	86	87	88	89	90
		High Side	262	270	290	309	329	349	370	390	411
	80° DB 67° WB	Low Side	87	89	90	91	92	93	94	95	96
		High Side	258	277	297	317	337	358	379	400	422
	85° DB 72° WB	Low Side	90	92	93	94	95	96	97	98	99
		High Side	267	287	307	328	349	371	392	414	437
WE701	75° DB 62° WB	Low Side	68	70	72	74	76	77	79	79	81
		High Side	231	248	265	283	301	321	340	362	382
	80° DB 67° WB	Low Side	73	75	77	79	81	82	84	85	87
		High Side	237	254	272	290	309	329	349	371	392
	85° DB 72° WB	Low Side	76	78	80	82	84	85	87	88	90
		High Side	245	263	282	300	320	341	361	384	406

Low side pressure ± 2 PSIG

High Side pressure ± 5 PSIG

Tables are based upon rated CFM (airflow) across the evaporator coil. If there is any doubt as to correct operating charge being in the system, the charge should be removed, system evacuated and recharge to serial plate instructions.

**TABLE 11  
OPTIONAL ACCESSORIES**

Part Number	Description	WE252-D	WE252-F	WE301-D WE371-D	WE301-F WE371-F	WE421-F WE482-F WE502-F WE701-F
BOP-2 BOP-3 BOP-5	Blank Off Plate Blank Off Plate Blank Off Plate	X	X	X	X	X
BFAD-2 BFAD-3 BFAD-5	Barometric Fresh Air Damper Barometric Fresh Air Damper Barometric Fresh Air Damper	X	X	X	X	X
MFAD-2 MFAD-3 MFAD-5	Motorized Fresh Air Damper Motorized Fresh Air Damper Motorized Fresh Air Damper	X	X	X	X	X
CRV-2 CRV-3 CRV-5	Commercial Room Ventilator Commercial Room Ventilator Commercial Room Ventilator	X	X	X	X	X
EIFM-2 EIFM-3 EIFM-5	Economizer With Exhaust Economizer With Exhaust Economizer With Exhaust	X	X	X	X	X
EHWA02-A05	Heater Package	X				
EHWA02A-A08	Heater Package	X				
EHWH24B-C05	Heater Package		X			
EHWA03-A05	Heater Package			X		
EHWA03-A10	Heater Package			X		
EHWA03-C05	Heater Package				X	
EHWA03-C12	Heater Package				X	
EHWA05A-C09	Heater Package					X
EHWA05A-F14	Heater Package					X

# NOTICE

## The refrigeration system in this unit is charged with refrigerant R-407C

### SERVICE PROCEDURE AND CONSIDERATIONS

Refrigerant R-407C is a blend of three refrigerants, HFC-32/HFC-125/HFC134A. Unlike pure fluids and azeotropes, blends boil and condense at varying temperatures for a given pressure. The range over which the temperature varies is referred to as temperature glide. R-407C has moderately high temperature glide between about 9° F and 13° F (5 to 7.2 Celsius) depending upon pressure.

When dealing with blends, pressure temperature tables are presented in an unconventional manner. Two temperatures are listed for the same pressure – the liquid temperature and the vapor temperature.

When a pressure reading is taken from the suction line or discharge line it is converted to temperature from the "Vapor Temperature" column on the pressure temperature chart.

When a pressure reading is taken at the liquid line it is converted to temperature from the "Liquid Temperature" column on the pressure temperature chart.

All Bard "WE" models have a pressure tap in the suction line and the liquid line.

See Pressure Temperature Table 12 on page 21.

### CHARGING

When charging a system with R-407C only the liquid phase is to be used to ensure proper refrigerant composition and system performance.

When charging the system into the suction side, care must be exercised to avoid damage to the compressor. Because the refrigerant leaving the refrigerant cylinder must be in liquid phase, it is suggested that a sight glass be connected between the charging hose and the suction service port. This will permit you to adjust the cylinder hand valve so that liquid can leave the cylinder while allowing vapor to enter the compressor.

The proper refrigerant amount is shown on the unit rating plate.

### LEAKS

If a significant leak develops in the system and a noticeable change in the system performance occurs, remove the remaining refrigerant with proper refrigerant recovery methods, repair the leak with proper industry practice and methods, and then, after evacuation, recharge the system with new refrigerant. Again, charge only with liquid refrigerant to ensure that the proper composition is in the system.

## CAUTION

Leak checking should never be done with a mixture of R-407C and air. Leak checking can be performed safely with a mixture of R-407C and nitrogen. Make sure the leak detector is capable of detecting R-407C before using.

### Notice:

When opening a system care must be taken to minimize the system exposure to atmosphere. Exposure for more than five minutes could shorten the life of the system. The compressor in this system contains Polyol Ester (POE) oil. POE's are very hygroscopic. They absorb moisture from the atmosphere at a much faster rate than mineral oils used in R-22 systems.

This system has a factory-installed filter drier in the liquid line. It is highly recommended that the filter drier be replaced when the system has been open. Make sure the replacement filter drier is suitable and approved for use with R-407C.

Before recharging the system, a vacuum of 250 microns or less must be achieved.

**TABLE 12**  
**R-407C SATURATED VAPOR/LIQUID**  
**TEMPERATURE/PRESSURE CHART**

Pressure (PSIG)	Liquid Temp. (F°)	Vapor Temp. (F°)	Pressure (PSIG)	Liquid Temp. (F°)	Vapor Temp. (F°)
20	-10.7	1.5	150	74.8	84.9
22	-8.2	4.0	155	76.8	86.8
24	-5.7	6.4	160	78.7	88.7
26	-3.4	8.7	165	80.6	90.5
28	-1.1	11.0	170	82.5	92.3
30	1.1	13.1	175	84.3	94.0
32	3.2	15.2	180	86.1	95.8
34	5.3	17.2	185	87.8	97.5
36	7.3	19.2	190	89.5	99.1
38	9.2	21.0	195	91.3	100.7
40	11.1	22.9	200	92.9	102.3
42	12.9	24.7	205	94.6	103.9
44	14.7	26.4	210	96.2	105.4
46	16.4	28.1	215	97.7	107.0
48	18.1	29.7	220	99.3	108.4
50	19.7	31.3	225	100.8	109.9
52	21.3	32.9	230	102.3	111.4
54	22.9	34.4	235	103.8	112.8
56	24.4	35.9	240	105.3	114.2
58	25.9	37.4	245	106.7	115.6
60	27.4	38.8	250	108.2	116.9
62	28.8	40.2	255	109.6	118.2
64	30.2	41.6	260	111.0	119.6
66	31.6	43.0	265	112.3	120.9
68	33.0	44.3	270	113.7	122.1
70	34.3	45.6	275	115.0	123.4
72	35.6	46.9	280	116.3	124.7
74	36.9	48.1	285	117.6	125.9
76	38.2	49.3	290	118.9	127.1
78	39.4	50.6	295	120.2	128.3
80	40.6	51.8	300	121.4	129.5
82	41.9	52.9	305	122.7	130.7
84	43.0	54.1	310	123.9	131.8
86	44.2	55.2	315	125.1	133.0
88	45.4	56.3	320	126.3	134.1
90	46.5	57.4	325	127.5	135.2
92	47.6	58.5	330	128.7	136.3
94	48.7	59.6	335	129.8	137.4
96	49.8	60.7	340	131.0	138.5
98	50.9	61.7	345	132.1	139.6
100	51.9	62.7	350	133.2	140.6
105	54.5	65.2	355	134.3	141.7
110	57.0	67.7	360	135.4	142.7
115	59.5	70.0	365	136.5	143.7
120	61.8	72.3	370	137.6	144.7
125	64.1	74.8	375	138.7	145.7
130	66.4	76.7	380	139.8	145.7
135	68.5	78.8	385	140.8	147.7
140	70.7	80.9	390	141.8	148.7
145	72.8	82.9	395	142.9	149.6

















