

Wire tucked in cable duct if no OD switch (only use with LAC)

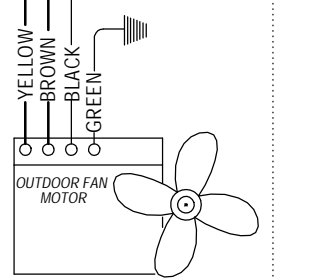
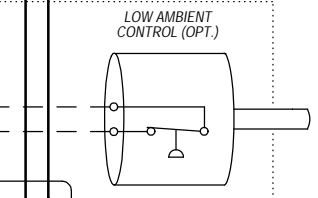
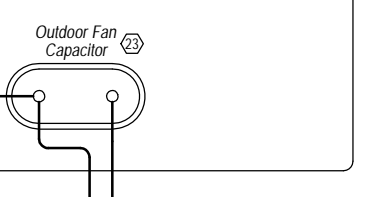
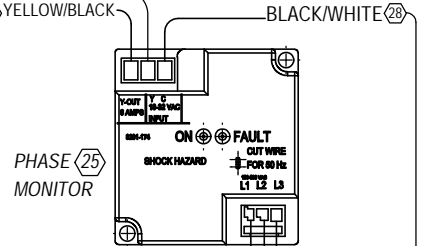
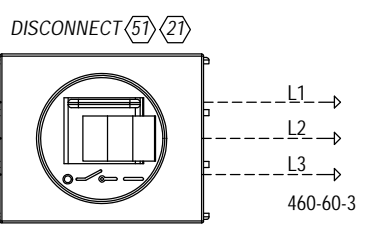
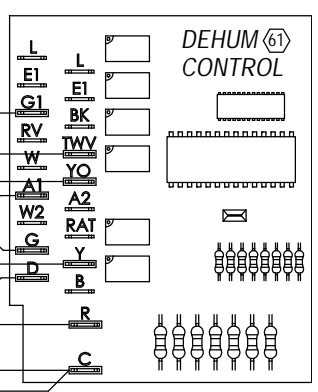

Model	Fan Capacitor
W48G*DC	15 / 370
W60G*DC	N/A

⚠ TO CHANGE COOLING BLOWER SPEEDS, SWAP BLUE AND ORANGE WIRES

IF ANY ORIGINAL WIRES SUPPLIED WITH THE APPLIANCE MUST BE REPLACED, IT MUST BE REPLACED WITH WIRING MATERIAL HAVING A TEMPERATURE RATING OF AT LEAST 105° C EXCEPT THE IGNITION CABLE WHICH IS 250° C HIGH VOLTAGE CABLE

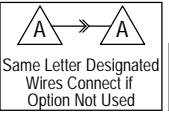

Wire Identification numbers for Bard use only. (99)

2 RED - HIGH PRESSURE FAULT
 BLUE - LOW PRESSURE FAULT
 BLUE FLASH - LOW VOLTAGE

⚠ DANGER
 ELECTRICAL SHOCK HAZARD
 DISCONNECT POWER BEFORE SERVICING.

⚠ WARNING
 USE COPPER CONDUCTORS
 ONLY SUITABLE FOR AT LEAST 75° C.

	Factory	Field	Optional
High Voltage			
Low Voltage			