

⚠ IF94-80

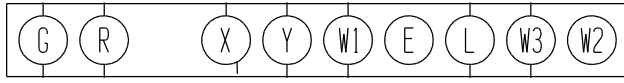

FUEL SAVER MODULE
PART # FSM-1D
MUST BE INSTALLED
INDOORS

T874N1024/Q67F1261



T874R1129/Q674L1181
OR
IF58-45

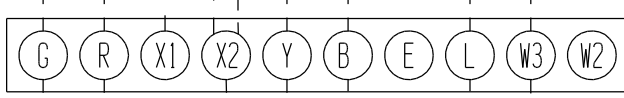

FAN CENTER TERMINALS
OR ELECTRONIC
BLOWER CONTROL

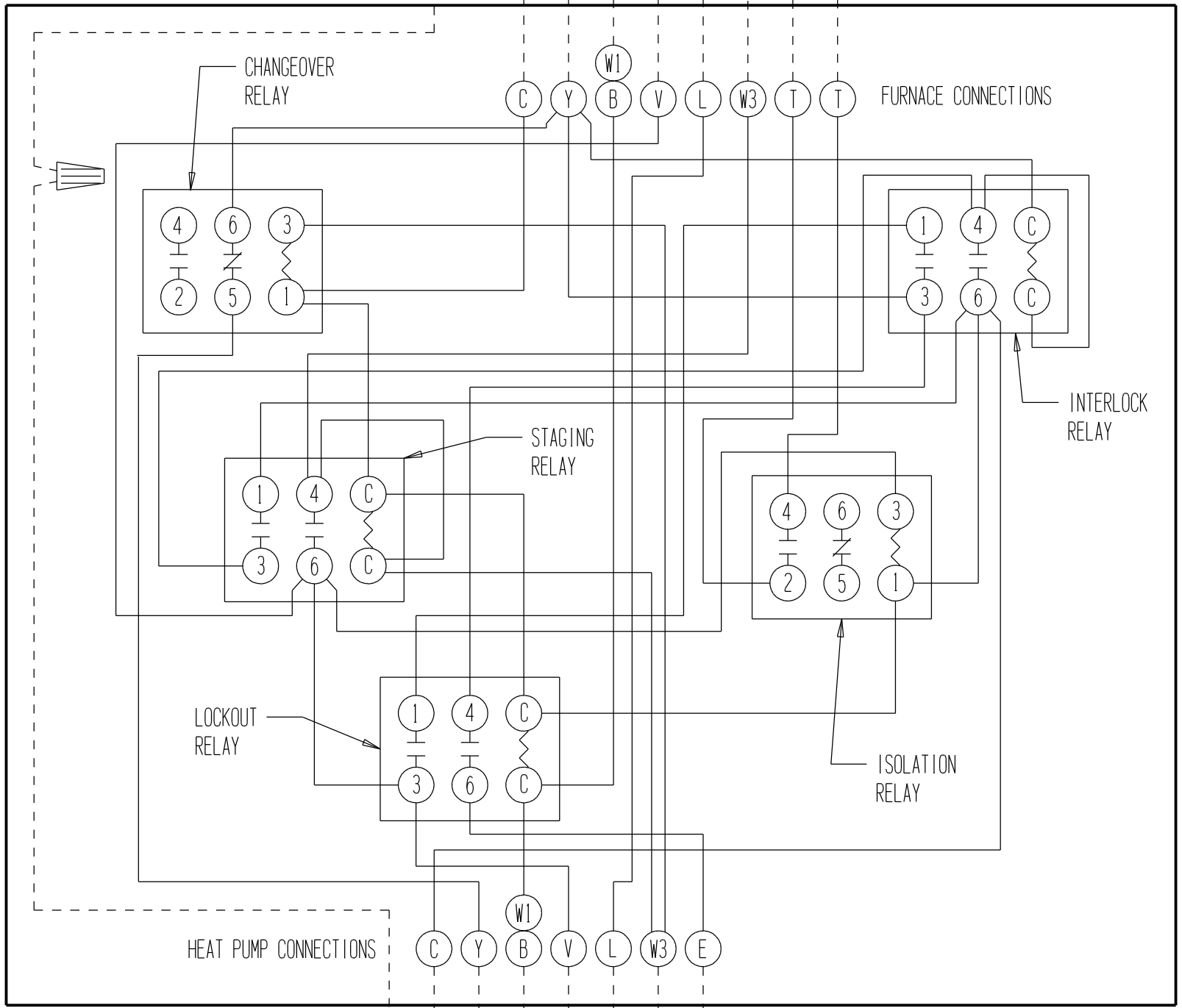
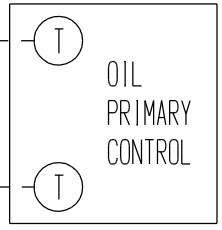
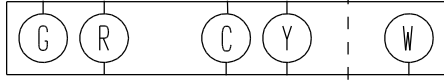

24 - 60 UHP MODELS
24V TERMINAL STRIP

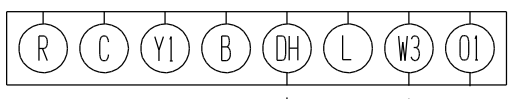

THESE WIRES REQUIRED
ONLY IF OPTIONAL
OUTDOOR THERMOSTAT
IS USED

BROWN
(NOT USED)

BLUE

OPTIONAL OUTDOOR
THERMOSTAT USED AS
LOW AMBIENT CUT OFF
OR ECONOMIC BALANCE
POINT CONTROL

YELLOW

⚠ OPTION SWITCH SETTING

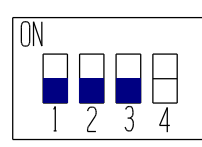

SWITCH #1 "OFF"
SWITCH #2 "OFF"
SWITCH #3 "OFF"
SWITCH #4 SEE THERMOSTAT
INSTALLATION INSTRUCTIONS

MAKE (DH) CONNECTION ONLY IF
DESIRED TO OPERATE THE FURNACE
DURING DEFROST CYCLE

λ ⚡