

---

# SERVICE INSTRUCTIONS

---

## FUSION-TEC™ WALL-MOUNT AIR CONDITIONER

Models:  
HR58APA  
HR58APB

Part of the Bard Free Cooling Unit System

***NOTE: LV1000 Controller is required for operation when multiple HR58AP\* units are used.***



Climate Control Solutions

Bard Manufacturing Company, Inc.  
Bryan, Ohio 43506  
[www.bardhvac.com](http://www.bardhvac.com)

Manual : 2100-670  
Supersedes: **NEW**  
Date: 6-2-17

# CONTENTS

---

## Using the TEC-EYE™ .....6

- TEC-EYE Hand-Held Diagnostic Tool ..... 6
- TEC-EYE Menu Structure ..... 7
- TEC-EYE Acronyms ..... 7
- Status Screen ..... 7
- Quick Menu ..... 7
  - Setpoints ..... 7
  - Information ..... 8
  - Data (Alarm) Log ..... 8
  - Menu Screens and Password Levels ..... 8

## Operation .....9

- Unit On/Off ..... 9
- Alarm Adjustment ..... 9
  - Acknowledging/Clearing Alarms ..... 9
- Stand Alone Mode ..... 9
- Temperature/Humidity Control ..... 9
  - Temperature/Humidity Control Components .. 9
    - Return Air Temperature Sensor ..... 9
    - Return Air Temperature Alarm ..... 10
  - Temperature/Humidity Control Operation .... 10
    - Cooling ..... 10
    - Heating ..... 11
    - Staging ..... 11
    - Dehumidification ..... 12
- Electronic Expansion Valve (EEV) ..... 12
  - EEV Components ..... 12
    - Electronic Expansion Valve ..... 12
    - Low Pressure Transducer ..... 12
      - Suction Pressure Alarm ..... 12
    - Suction Temperature Sensor ..... 12
      - Suction Temperature Alarm ..... 12
  - EEV Operation ..... 13
    - EEV Superheat Control ..... 13
    - EEV Instructions for Vacuum, Reclaim, Charge Unit ..... 13
    - System Pressures ..... 14
  - Additional EEV Alarms ..... 14
    - Low Superheat Alarm ..... 14
- Indoor Airflow ..... 14
  - Indoor Airflow Components ..... 14
    - Blower ..... 14
      - Blower Status Alarm ..... 15
    - Differential Airflow Switch ..... 15
    - Filters ..... 16
      - Dirty Filter Switch ..... 16
        - Dirty Filter Alarm ..... 17
      - Filter Indicator Light ..... 17
    - Freezestat ..... 17
      - Freezestat Alarm ..... 17
  - Indoor Airflow Operation ..... 18
    - Blower Speed Control ..... 18
  - Additional Indoor Airflow Alarms ..... 18
    - Supply Air Temperature Alarm ..... 18
- Condenser Fan ..... 18
  - Condenser Fan Components ..... 18

- Condenser Fan ..... 18
  - High Pressure Transducer ..... 19
    - High Pressure Transducer Alarm .... 19
  - Discharge Temperature Sensor ..... 19
- Condenser Fan Operation ..... 19
  - Condenser Fan Speed Control ..... 19
  - High Pressure Control ..... 20
  - Low Pressure Control ..... 20
  - Additional Condenser Fan Alarms ..... 20
    - Dirty Condenser Coil Alarm ..... 20
- Compressor ..... 21
  - Compressor Components ..... 21
    - Compressor ..... 21
    - Compressor Control Module (CCM) ..... 21
    - High Pressure Safety Switch ..... 21
      - Refrigerant High Pressure Alarm .... 21
    - Phase Monitor ..... 22
  - Compressor Operation ..... 22
    - Additional Compressor Alarms ..... 22
      - Refrigerant Low Pressure Alarm ..... 22
- Economizer ..... 23
  - Economizer Components ..... 23
    - Actuator ..... 23
    - Dust Sensor ..... 23
      - Dust Sensor Failure Alarm ..... 24
      - Dust Limit Alarm ..... 24
  - Damper Blade ..... 24
  - Damper Switch ..... 24
    - Damper Failed to Open Alarm ..... 25
    - Damper Failed to Close Alarm ..... 25
  - Outdoor Temperature and Humidity Combination Sensor ..... 25
    - Outdoor Temperature Sensor Failure Alarm ..... 26
    - Outdoor Humidity Sensor Failure Alarm ..... 26
  - Supply Temperature Sensor ..... 26
    - Supply Temperature Sensor Failure Alarm ..... 26
      - High Supply Air Temperature Alarm ..... 26
      - Low Supply Air Temperature Alarm ..... 27
  - Economizer Operation ..... 27
- Emergency Ventilation Mode ..... 29
- Model/Serial Number Configuration ..... 29
- Electric Heat Option ..... 29
  - Electric Heat Components ..... 29
    - Electric Heating Element ..... 29
    - Thermal Overload ..... 29
  - Electric Heat Operation ..... 29
- Bard Guard Anti-Theft System Option ..... 29
- Smoke Detector Option ..... 29
- Inverter Option ..... 29

<b>Refrigerant Information .....</b>	<b>30</b>
General .....	30
Topping Off System Charge.....	30
Safety Practices .....	30
Important Installer Note.....	30
R410-A Refrigerant Charge .....	30
Pressure Service Ports .....	31
<b>Maintenance.....</b>	<b>32</b>
Standard Maintenance Procedures .....	32
Bard Guard Anti-Theft System Option.....	32

## FIGURES AND TABLES

Figure 1	TEC-EYE Display and Interface .....	6
Figure 2	TEC-EYE Connection to Unit Control .....	6
Figure 3	Quick Menu Icons.....	7
Figure 4	Cool and Heat Setpoints.....	7
Figure 5	Clearing All Alarms .....	9
Figure 6	Adjusting Return Air Sensor.....	10
Figure 7	Cooling w/Economizer .....	10
Figure 8	Viewing Unit Stages.....	11
Figure 9	Cooling w/No Economizer .....	11
Figure 10	Heating .....	11
Figure 11	Adjusting Low Pressure Sensor Values ....	12
Figure 12	Adjusting Suction Temperature Sensor Values .....	13
Figure 13	Overriding EEV Output .....	13
Figure 14	Electronic Expansion Valve (EEV) and Service Tool .....	13
Figure 15	Putting Blower Output into Override Mode.....	14
Figure 16	Adjusting Air Flow Alarm Delay .....	15
Figure 17	Dirty Filter Switch/Blower Status Switch..	15
Figure 18	Verifying Differential Airflow Status .....	16
Figure 19	Dirty Filter Switch/Filter Indicator Light..	16
Figure 20	Verifying Freeze Switch Status .....	17
Figure 21	Adjusting Freezestat Alarm Delay .....	18
Figure 22	Verifying Condenser Fan Output .....	18
Figure 23	Fan Blade Setting.....	18
Figure 24	Adjusting High Pressure Input .....	19
Figure 25	Adjusting Discharge Temperature Input...	19
Figure 26	Pressure Control .....	20
Figure 27	Adjusting Dirty Condenser Alarm Settings.....	21
Figure 28	Adjusting Compressor Delays .....	22
Figure 29	Adjusting Low Pressure Alarm Settings ...	23
Figure 30	Damper Override .....	23
Figure 31	Dust Sensor .....	24
Figure 32	Adjusting Dust Sensor Alarm Setpoint ....	24
Figure 33	Damper Switch.....	24
Figure 34	Adjusting Damper Alarm Delay.....	25
Figure 35	Outdoor Air Sensor .....	25
Figure 36	Outdoor Humidity Sensor .....	26
Figure 37	Supply Air Sensor .....	26
Figure 38	Adjusting Supply Air Temperature Differential .....	27
Figure 39	Economizer Setup .....	27
Figure 40	Economizer Setup – Enthalpy Control .....	28
Figure 41	Economizer Setup – TempHum Control ...	28
Table 1	Unit Status Message.....	7
Table 2	LV1000/TEC-EYE Passwords (Defaults)....	8
Table 3	Blower Speeds .....	14
Table 4	Rated Airflow .....	15
Table 5	Indoor Blower Performance.....	15
Table 6	Maximum ESP of Operation: Electric Heat Only .....	15
Table 7	Filter Switch Pressure Settings .....	17
Table 8	Condenser Fan Speeds.....	20
Table 9	Economizer Default Settings.....	28
Table 10	Cooling Pressures .....	31

# GENERAL INFORMATION

---

## Free Cooling Unit System

This Bard Free Cooling Unit System is composed of FUSION-TEC wall-mounted air conditioners matched with an LV1000 lead/lag controller. The wall mounts are specifically engineered for telecom/motor control center rooms.

**NOTE:** *The LV1000 lead/lag controller and FUSION-TEC wall-mount units are designed specifically to work together. The controller cannot run other Bard models or other brands of systems, nor can other controllers run the FUSION-TEC wall-mount units. They are a complete system, and must be used together.*

## Wall-Mount Air Conditioner Units

The FUSION-TEC units operate on VAC power. The units will supply 100% of rated cooling airflow in free cooling mode with ability to exhaust the same amount through the unit itself without any additional relief openings in the shelter.

Each of these units are fully charged with refrigerant and have optional auxiliary heat.

## General

The equipment covered in this manual is to be installed by trained, experienced service and installation technicians.

The refrigerant system is completely assembled and charged. All internal wiring is complete.

The unit is designed for use without duct work. Flanges are provided for transition from unit to wall grilles.

These instructions explain the recommended method to install the air cooled self-contained unit and the electrical wiring connections to the unit.

These instructions and any instructions packaged with any separate equipment required to make up the entire air conditioning system should be carefully read before beginning the installation. Note particularly any tags and/or labels attached to the equipment.

While these instructions are intended as a general recommended guide, they do not supersede any national and/or local codes in any way. Authorities having jurisdiction should be consulted before the installation is made. See **Additional Publications** for information on codes and standards.

Sizing of systems for proposed installation should be based on heat loss and heat gain calculations made according to methods of Air Conditioning Contractors of America (ACCA). The supply flange should be installed in accordance with the *Standards of the National Fire Protection Association for the Installation of Air*

*Conditioning and Ventilating Systems of Other Than Residence Type, NFPA No. 90A, and Residence Type Warm Air Heating and Air Conditioning Systems, NFPA No. 90B.* Where local regulations are at a variance with instructions, installer should adhere to local codes.

## Shipping Damage

Upon receipt of equipment, the cartons should be checked for external signs of shipping damage. If damage is found, the receiving party must contact the last carrier immediately, preferably in writing, requesting inspection by the carrier's agent.

These units must remain in upright position at all times.

## Additional Publications

These publications can help when installing the furnace. They can usually be found at the local library or purchased directly from the publisher. Be sure to consult the current edition of each standard.

National Electrical Code .....ANSI/NFPA 70  
Standard for the Installation of Air Conditioning and Ventilating Systems .....ANSI/NFPA 90A  
Standard for Warm Air Heating and Air Conditioning Systems .....ANSI/NFPA 90B  
Load Calculation for Residential Winter and Summer Air Conditioning ..... ACCA Manual J

For more information, contact these publishers:

**Air Conditioning Contractors of America (ACCA)**  
1712 New Hampshire Ave. N.W.  
Washington, DC 20009  
Telephone: (202) 483-9370 Fax: (202) 234-4721

**American National Standards Institute (ANSI)**  
11 West Street, 13th Floor  
New York, NY 10036  
Telephone: (212) 642-4900 Fax: (212) 302-1286

**American Society of Heating, Refrigeration and Air Conditioning Engineers, Inc. (ASHRAE)**  
1791 Tullie Circle, N.E.  
Atlanta, GA 30329-2305  
Telephone: (404) 636-8400 Fax: (404) 321-5478

**National Fire Protection Association (NFPA)**  
Batterymarch Park  
P. O. Box 9101  
Quincy, MA 02269-9901  
Telephone: (800) 344-3555 Fax: (617) 984-7057

### **ANSI Z535.5 Definitions:**

**DANGER:** Indicate[s] a hazardous situation which, if not avoided, will result in death or serious injury. The signal word “DANGER” is to be limited to the most extreme situations. DANGER [signs] should not be used for property damage hazards unless personal injury risk appropriate to these levels is also involved.

**WARNING:** Indicate[s] a hazardous situation which, if not avoided, could result in death or serious injury. WARNING [signs] should not be used for property damage hazards unless personal injury risk appropriate to this level is also involved.

**CAUTION:** Indicate[s] a hazardous situation which, if not avoided, could result in minor or moderate injury. CAUTION [signs] without a safety alert symbol may be used to alert against unsafe practices that can result in property damage only.

**NOTICE:** [this header is] preferred to address practices not related to personal injury. The safety alert symbol shall not be used with this signal word. As an alternative to “NOTICE” the word “CAUTION” without the safety alert symbol may be used to indicate a message not related to personal injury.



## **WARNING**

***Electrical shock hazard.***

***Have a properly trained individual perform these tasks.***

***Failure to do so could result in electric shock or death.***

## **WARNING**

***Fire hazard.***

***Maintain minimum 1/4" clearance between the supply flange and combustible materials.***

***Failure to do so could result in fire causing damage, injury or death.***

## **WARNING**

***Heavy item hazard.***

***Use more than one person to handle unit.***

***Failure to do so could result in unit damage or serious injury.***

## **CAUTION**

***Cut hazard.***

***Wear gloves to avoid contact with sharp edges.***

***Failure to do so could result in personal injury.***

# USING THE TEC-EYE™

**FIGURE 1**  
TEC-EYE (Bard P/N 8301-059) Display and Interface (Status Screen Shown)



**ALARM KEY**

Allows viewing of active alarms  
Silences audible alarms  
Resets active alarms

**MENU KEY**

Allows entry to Main Menu

**ESCAPE KEY**

Returns to previous menu level  
Cancels a changed entry

**UP KEY**

Steps to next screen in the display menu  
Changes (increases) the value of a modifiable field

**ENTER KEY**

Accepts current value of a modifiable field  
Advances cursor

**DOWN KEY**

Steps back to previous screen in the display menu  
Changes (decreases) the value of a modifiable field

## TEC-EYE Hand-Held Diagnostic Tool

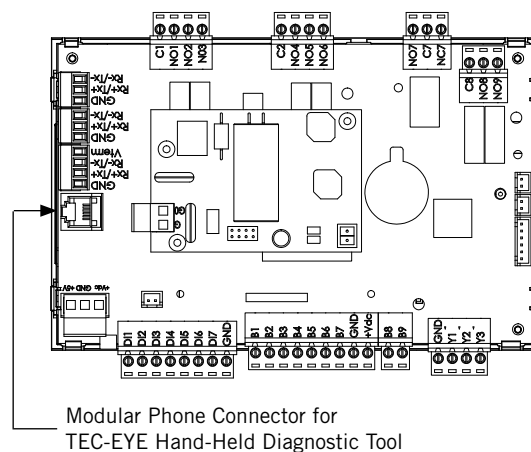
The microprocessor control used in the FUSION-TEC wall-mount air conditioners allows for complete control and monitoring through the use of the provided TEC-EYE hand-held monitor. This comprehensive service tool utilizes the latest in state-of-the-art technology including a large, easy-to-read backlit LCD graphic display.

The menu driven interface provides users the ability to scroll through two menu levels: Quick Menu and Main Menu. The menus permit the user to easily view, control and configure the unit.

The controller is completely programmed at the factory; the default setpoints and their ranges are easily viewed and adjusted from the TEC-EYE display. The program and operating parameters are permanently stored on FLASH-MEMORY in case of power failure. The controller is designed to manage temperature levels to a user-defined setpoint via control output signals to the wall mount air conditioning system.

The TEC-EYE connects to the wall-mount unit control board via an RJ11 modular phone connector as shown in Figure 2.

**FIGURE 2**  
TEC-EYE Connection to Unit Control



**NOTE:** Screenshots shown in this manual reflect default settings (when applicable).

When not being used, the TEC-EYE hand-held diagnostic tool should be stored inside or near the LV1000 controller. Do not let the TEC-EYE leave the shelter.

## TEC-EYE Menu Structure

### Quick Menu

- Setpoints
- Information
- Alarm Log

### Main Menu

- System Configuration
- Advanced System Configuration
- I/O Configuration
- On/Off
- Alarm Logs
- Settings
- Logout

In addition to the menu structure above, there are also Status and Alarm screens.

### TEC-EYE Acronyms

MAT – Mixed air temperature  
 RAT – Return air temperature  
 OAT – Outdoor air temperature  
 OAH – Outdoor air humidity  
 Blower – Indoor blower status  
 Damper – Free cooling damper position status  
 CL1 – Compressor stage 1 status  
 CL2 – Compressor stage 2 status  
 H1 – Heater stage 1 status  
 H2 – Heater stage 2 status  
 ODP – Calculated outdoor dew point  
 FC – Free cooling status  
 RN – Component run time in minutes in last hour  
 ST – Number of start requests in last hour

**NOTE:** *Digital refers to On/Off whereas analog is a variable input.*

### Status Screen

The Status screen is the default start-up screen and also the return screen after 5 minutes of no activity. The screen can be accessed any time by pressing the ESCAPE key repeatedly.

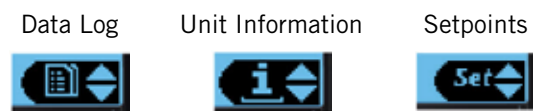
The wall-mount unit address is displayed in the upper right corner on the Status screen (see Figure 1). The Status screen also shows the current date, time, return air temperature, mixed air temperature, outdoor air temperature, outdoor humidity and outdoor dew point conditions. Blower, damper and unit status are also displayed. See Table 1 for wall-mount unit status messages.

The Quick Menu is accessible from the Status screen. Setpoints, Information and Data (Alarm) Log are available through the Quick Menu. Pressing the UP or DOWN keys while on the Status screen will change the Quick Menu icon displayed (see Figure 3). Press the ENTER key when the desired icon is displayed.

**TABLE 1**  
**Unit Status Messages**

Message	Description
Orphan Stby	Unit is on and in orphan mode with no calls for heating or cooling
Power Loss	Unit is operating under power loss conditions (inverter model)
Freecooling	Unit is actively economizing
Cooling	Unit is actively mechanical cooling
Heating	Unit is actively heating
Dehum Mode	Unit is actively dehumidifying
Off by Alarm	Unit has major fault preventing operation
Off by Keyboard	Unit has been turned off by local user
Off by LV	Unit has been turned off by the supervisory controller
Manual Mode	There is an active override on the system
Test Mode	System is performing a run test
Emergency Vent	Unit has active hydrogen alarm and is actively exhausting the air to outside
Emergency Off	Unit has active smoke alarm and Emergency Shutdown is active

**FIGURE 3**  
**Quick Menu Icons**



### Quick Menu

#### Setpoints

From this screen, the unit heating and cooling setpoints can be changed.

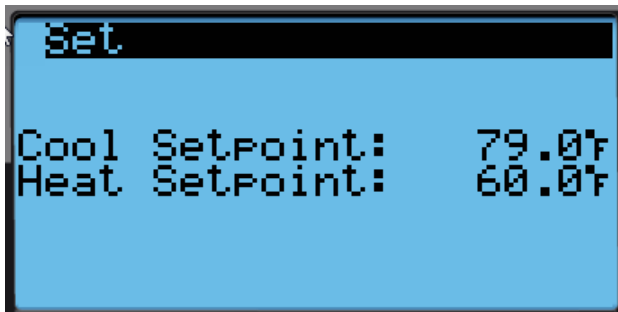
The *LV1000* setpoints will determine the cooling and heating setpoints when *communicating with the wall-mount units*. The *unit* cooling and heating setpoints will determine the cooling and heating setpoints when *in stand alone mode*.

If at any time the unit(s) loses communication with the LV1000 controller, the unit(s) will go into stand alone mode.

To verify or change the wall-mount unit cooling and heating setpoints in stand alone mode:

1. Connect the TEC-EYE diagnostic tool to the control board located in the unit.
2. From the Status screen, press UP or DOWN key until Quick Menu displays Setpoints icon. Press ENTER key.
3. Press ENTER key to scroll to the selected choice (see Figure 48).
4. Press UP or DOWN key on desired value until value displays correctly.
5. Press ENTER key to save and scroll to next parameter.
6. Press ESCAPE key until Main Menu screen is displayed.

**FIGURE 4**  
**Cool and Heat Setpoints**



**Information**

These screens show unit demand, wall unit status, serial/model number, hours, run hours, averages and program version information.

**Data (Alarm) Log**

The alarm log screens show a log of each alarm. There will be a log for when alarm occurred and if the alarm auto clears, it will show when the alarm cleared.

**TABLE 2**  
**LV1000/TEC-EYE Passwords (Defaults)**

User	2000
Technician	1313
Engineer	9254
Use UP or DOWN keys and ENTER key to enter password	

**Menu Screens and Password Levels**

- A** System Config: A1-A10 User
- B** Adv Sys Config: B1-B4 Technician
- C** I-O Config: C1-C18 Technician
- D** On/Off: User
- E** Alarm Logs: User
- F** Settings:
  - Date/Time: Technician
  - Language: User
  - Network Config: Technician
  - Serial Ports: Technician
  - Initialization:
    - Clear Logs: User
    - System Default: Engineer
    - Restart: User
    - Parameter Config: Engineer
    - Alarm Export: User
- G** Logout: Used to log out of the current password level. Entering back into the menu requires password.

**NOTE:** Screenshots shown in this manual reflect default settings (when applicable).



## Unit On/Off

The wall unit can be turned on and off from the TEC-EYE. Turning the unit off with the following instructions will disable heating and cooling operation but may not disable the blower. The blower may continue to run if the unit or the LV1000 have the continuous blower option enabled.

**NOTE:** Blower will run if the unit is in stand alone mode.

To turn the unit on or off:

1. Press MENU key to go to the Main Menu screen.
2. Press UP or DOWN keys and ENTER key to enter USER password 2000.
3. Press UP or DOWN keys to scroll to **On/Off**; press ENTER key.
4. Press UP or DOWN keys to change value from On to Off or from Off to On.
5. Press ESCAPE key several times to return to Main Menu screen.

The wall unit may also be turned off by certain alarms such as the smoke alarm input on the wall unit board or the return air temperature sensor failure when not connected to the LV1000.

## Alarm Adjustment

### Acknowledging/Clearing Alarms

Alarm conditions activate a red LED indicator that backlights the ALARM function key. As an option, an alarm condition may also be enunciated by an audible alarm signal. An alarm is acknowledged by pressing the ALARM key. This calls up alarm display screen(s) that provide a text message detailing the alarm condition(s). After an alarm condition is corrected, the alarm can be cleared by pressing the ALARM key for 3 seconds.

To clear all alarms, navigate to the end of the alarm list to the screen shown in Figure 5.

**FIGURE 5**  
Clearing All Alarms



## Stand Alone Mode

With the AC breakers turned on, each FUSION-TEC wall-mount unit has the capability to run without the LV1000 controller attached—this feature is called stand alone or orphan mode. This keeps the shelter between 60°F and 79°F (factory default settings) by the use of the factory-installed return air sensor in each wall-mount unit. In stand-alone mode, the wall unit uses a continuous blower setting to circulate room air into the return air inlet and uses the return air temperature sensor to control room temperature.

The wall-mount unit can be turned on and off with the TEC-EYE hand-held diagnostic tool. When ON is chosen, the wall unit will heat or cool. The blower will continue to run when OFF is chosen. If the wall unit is turned OFF by the TEC-EYE while in stand alone mode and power is interrupted, when repowered the blower will not run until the wall unit is turned back ON by the TEC-EYE (see **Unit On/Off**).

To change default setpoints, refer to **Setpoints** on page 7.

During installation, the ability to run in stand alone mode allows deactivation of one of the existing, older wall-mount units, while keeping the shelter cool with the other unit still operating. Once the first of the Bard FUSION-TEC wall-mount units is installed, orphan mode can be enabled early in the installation—keeping the climate inside the shelter stable and the installers comfortable while the remainder of the older equipment is removed and the remaining Bard FUSION-TEC wall-mount units and LV1000 controller are installed.

Additionally, should any or all of the FUSION-TEC wall-mount units lose communication with the LV1000 controller (such as during maintenance), they will continue to serve the shelter's needs until a repair can be made.

## Temperature/Humidity Control

### Temperature/Humidity Control Components

#### Return Air Temperature Sensor

The unit is equipped with a return air temperature sensor to monitor the space temperature when the unit is in stand alone mode. The return air sensor is located in the upper part of the return opening in such a way that it is exposed to the entering airstream. An alarm signal will be sent to the LV controller if the return air temperature sensor is disconnected. The temperature is measured with a 10k ohm NTC thermistor.

This sensor can be verified and adjusted by:

1. Press MENU key to go to the Main Menu screen.

2. Press UP or DOWN keys and ENTER key to enter TECHNICIAN password 1313.
3. Press UP or DOWN keys to scroll to **I/O Config**; press ENTER key.
4. Press UP or DOWN keys to scroll to **Return Air Sensor (C5)**; press ENTER key.
5. Verify the measurement displayed on screen is accurate (see Figure 6).
6. If the measurement needs to be adjusted, apply an offset value by pressing ENTER to scroll to **Offset**.
7. Press UP or DOWN keys to adjust the offset.
8. The update will not take effect until the cursor is moved out of the **Offset** parameter.
9. Once adjusted, press the ESCAPE key several times to return to Main Menu screen.

**FIGURE 6**  
Adjusting Return Air Sensor



### **Return Air Temperature Alarm**


When the return air temperature sensor value is out of range (-41.0 to 303.0°F), the controller will generate a sensor failure alarm to indicate the sensor is not working properly.

This alarm is fixed and cannot be adjusted.

### **Temperature/Humidity Control Operation**

The unit utilizes a PID control loop for space control. This control will compare the space temperature to the space setpoint. Based on how far away from the setpoint the temperature is, the loop will output a cooling or heating capacity number between 0 and 100%. The unit will then take all of the available cooling methods and distribute them evenly across the 0-100% range. The stages are then brought on as the heating or cooling capacity reaches the percentage that brings the stages on or off. There are separate setpoints for cooling and heating.

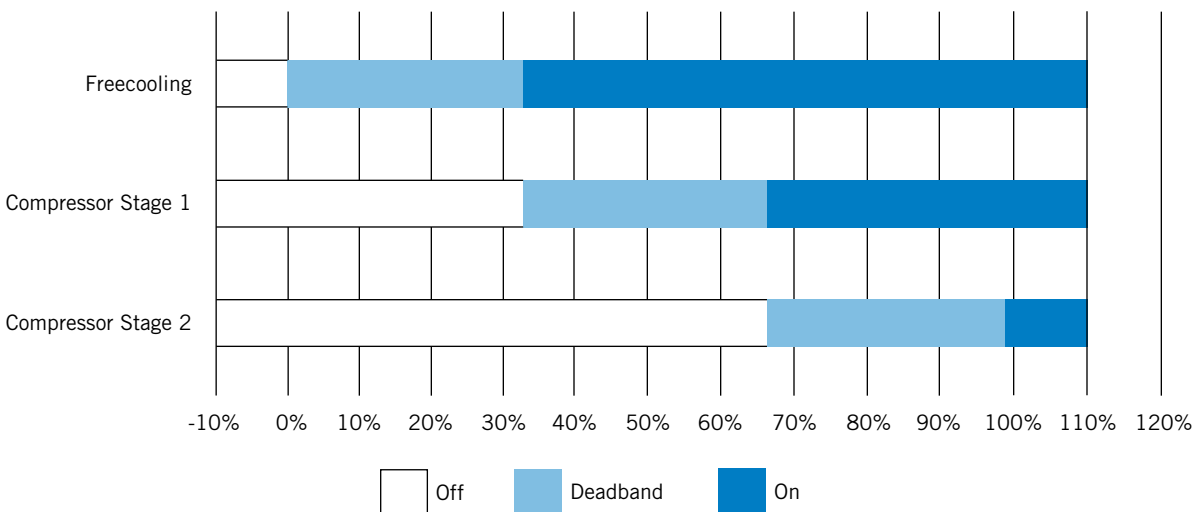
To change or view the unit setpoint:

1. From the Status screen, press UP or DOWN key until Quick Menu displays Setpoints icon (  ). Press ENTER key.
2. Press ENTER key to scroll to **Cool Setpoint** or **Heat Setpoint** (see Figure 4 on page 8).
3. Press UP or DOWN keys to change the value to desired heating and/or cooling setpoint.

### **Cooling**

The unit is equipped with 1 stage of freecooling and 2 stages of mechanical cooling (compressor and solenoid) for a total of 3 cooling stages (see Figure 7).

**FIGURE 7**  
Cooling w/Economizer



Deadband (sometimes called a neutral zone or dead zone) is an interval of a signal domain or band where no action occurs

The unit is equipped with 1 stage of freecooling and 2 stages of mechanical cooling (compressor and solenoid). However, the outdoor conditions are not favorable for economizer operation so there are a total of 2 cooling stages (see Figure 9).

**Heating**


The unit is equipped with 1 stage of electric heat (see Figure 10).

**Staging**

The unit will stage the cooling components based on the cooling demand referenced in the temperature control. The unit will stage the economizer on first if the indoor and outdoor conditions are favorable. The compressor stage 1 will be enabled next as the demand increases. Finally, the compressor stage 2 will be enabled as the demand continues to increase.

The unit is only equipped with one stage of heat and will turn on based on the heating demand.

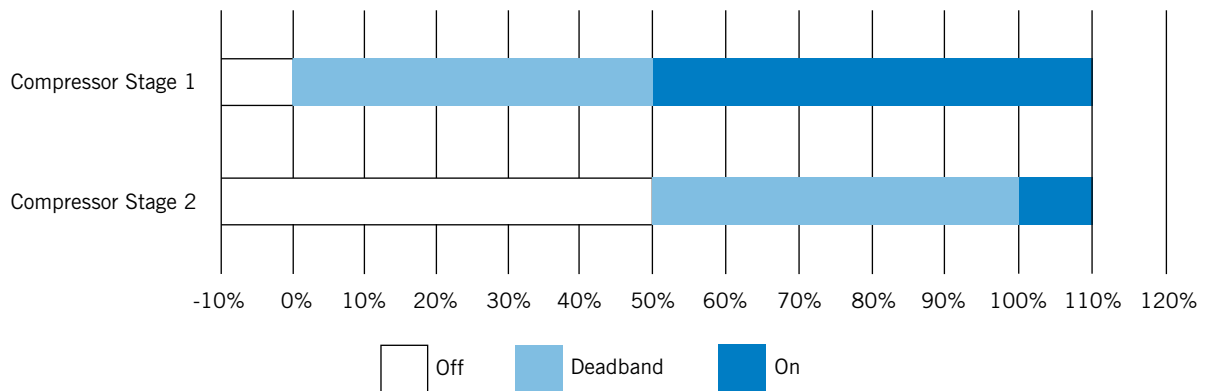
To view unit stages:

1. From the Status screen, press UP or DOWN key until Quick Menu displays Unit Information icon (  ). Press ENTER key.
2. The cooling and heating demand are visible on this screen. The unit stages will display here when active as FC, CL1, CL2 or H1 (see Figure 8).

**FIGURE 8**  
Viewing Unit Stages

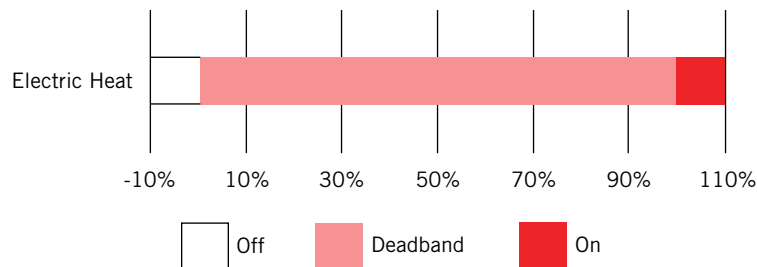


**FIGURE 9**  
Cooling w/No Economizer



Deadband (sometimes called a neutral zone or dead zone) is an interval of a signal domain or band where no action occurs

**FIGURE 10**  
Heating



Deadband (sometimes called a neutral zone or dead zone) is an interval of a signal domain or band where no action occurs

## Dehumidification

The unit uses a dehumidification sequence that does not require the electric heat to run at the same time as the compressor. Instead, the unit will turn on the compressor to cool down to the heating setpoint. Once the lower setpoint has been reached, the unit will heat the space back up to the upper setpoint. This cycle continues until the humidity level in the shelter reaches an acceptable level. At this point, the unit will revert back to normal operation. The economizer will also be disabled while the unit is in the dehumidification mode.

**NOTE:** This feature is dependent upon the LV1000 indoor humidity sensors and a command from the LV to enter dehumidification mode. See LV1000 Service Instructions 2100-673 for adjustment of the dehumidification setpoint and differentials.

## Electronic Expansion Valve (EEV)

### EEV Components

#### Electronic Expansion Valve

The electronic expansion valve is a stepper motor that is controlled with a step output from the controller. The valve is capable of 480 steps represented by a 0-100% signal on the controller. The motor drives a needle valve that regulates the flow of refrigerant.

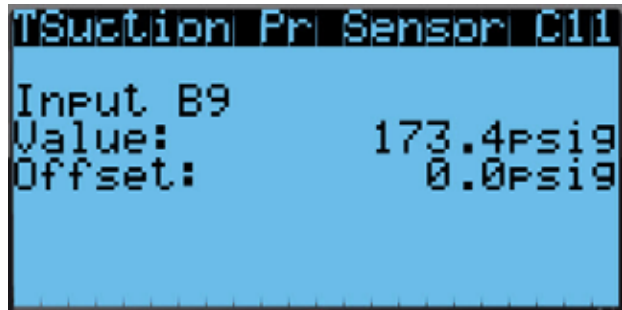
#### Low Pressure Transducer

The unit has a low side pressure transducer installed on the suction line between the evaporator coil and compressor. The transducer is used for system monitoring of low side system pressures. The sensor is used with the suction temperature sensor to provide a real time superheat calculation that determines the EEV position.

This sensor can be verified and adjusted by:

1. Press MENU key to go to the Main Menu screen.
2. Press UP or DOWN keys and ENTER key to enter TECHNICIAN password 1313.
3. Press UP or DOWN keys to scroll to **I/O Config**; press ENTER key.
4. Press UP or DOWN keys to scroll to **Suction Pr Sensor (C11)**; press ENTER key.
5. Verify the measurement displayed on screen is accurate (see Figure 11).
6. If the measurement needs to be adjusted, apply an offset value by pressing ENTER to scroll to **Offset**.
7. Press UP or DOWN keys to adjust the offset.
8. The update will not take effect until the cursor is moved out of the **Offset** parameter.
9. Once adjusted, press the ESCAPE key several times to return to Main Menu screen.

**FIGURE 11**  
**Adjusting Low Pressure Sensor Values**



#### Suction Pressure Alarm

When the suction temperature sensor value is out of range (0-250 PSIG), the controller will generate a sensor failure alarm to indicate the sensor is not working properly.

This alarm cannot be adjusted.

#### Suction Temperature Sensor

The suction temperature sensor is used to calculate superheat. The EEV uses this value to control the EEV. The temperature is measured with a 10k ohm NTC thermistor.

The suction temperature sensor measurement can be verified and adjusted by:

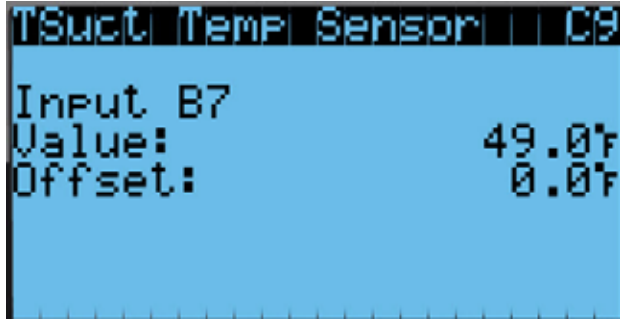
1. Press MENU key to go to the Main Menu screen.
2. Press UP or DOWN keys and ENTER key to enter TECHNICIAN password 1313.
3. Press UP or DOWN keys to scroll to **I/O Config**; press ENTER key.
4. Press UP or DOWN keys to scroll to **Suct Temp Sensor (C9)**; press ENTER key.
5. Verify the measurement displayed on screen is accurate (see Figure 12 ).
6. If the measurement needs to be adjusted, apply an offset value by pressing ENTER to scroll to **Offset**.
7. Press UP or DOWN keys to adjust the offset.
8. The update will not take effect until the cursor is moved out of the **Offset** parameter.
9. Once adjusted, press the ESCAPE key several times to return to Main Menu screen.

#### Suction Temperature Alarm

When the suction temperature sensor value is out of range (-41.0 to 303.0°F), the controller will generate a sensor failure alarm to indicate the sensor is not working properly.

This alarm cannot be adjusted.

**FIGURE 12**  
Adjusting Suction Temperature Sensor Values



**EEV Operation**

**EEV Superheat Control**

The electronic expansion valve (EEV) will open or close to maintain 10° of superheat while the compressor is running. When the compressor is not running, the valve will close.

Low superheat protection will be active once the superheat value is at or below 5°F. At this point, the control will aggressively close the valve so that superheat is maintained.

**EEV Instructions for Vacuum, Reclaim, Charge Unit**

The electronic expansion moves to the 0 position when the unit is not actively cooling. The valve may need to be manually positioned for service or troubleshooting.

The valve can be positioned by using a menu override.

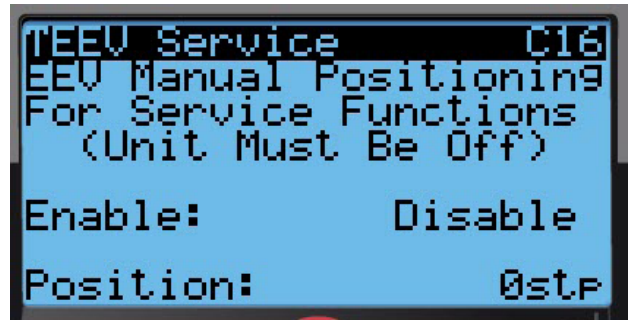
To manually override the valve:

**NOTE:** *The unit must be off to perform this override.*

1. Press MENU key to go to the Main Menu screen.

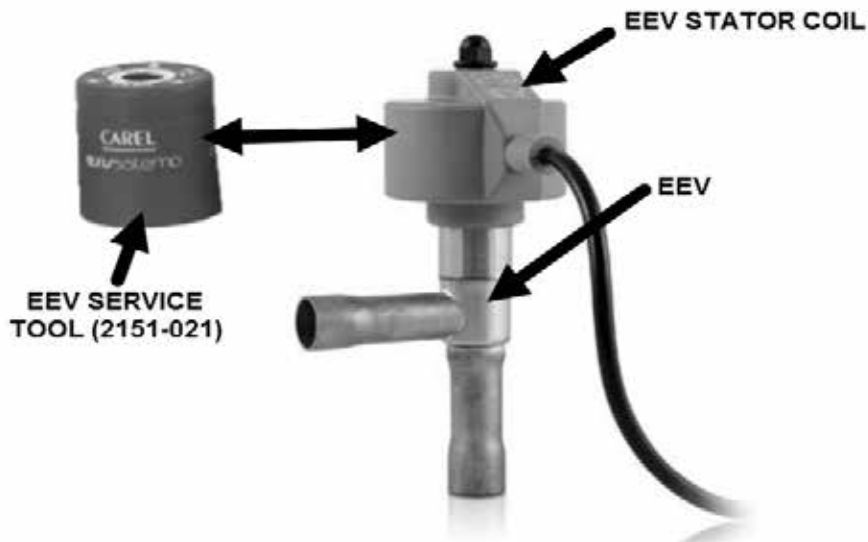
2. Press UP or DOWN keys and ENTER key to enter TECHNICIAN password 1313.
3. Press UP or DOWN keys to scroll to **I/O Config**; press ENTER key.
4. Press UP or DOWN keys to scroll to **TEEV Service (C16)**; press ENTER key.
5. Press ENTER key to scroll to **Enable** (see Figure 13).
6. Press UP or DOWN key to change **Disable** to **Enable**.
7. Press ENTER key to scroll to **Position**.
8. Press UP or DOWN keys to adjust to the desired value.
9. Press ENTER key to save.
10. Press the ESCAPE key several times to return to Main Menu screen.

**FIGURE 13**  
Overriding EEV Output



The valve can also be opened or closed using the EEV service tool (Bard Part # 2151-021). This magnetic EEV service tool (shown in Figure 14) is used to

**FIGURE 14**  
Electronic Expansion Valve (EEV) and Service Tool






manually open the EEV. To do this, remove the EEV stator coil (red color with retaining nut on top), slide the magnetic tool over the shaft where the stator was removed and turn in a clockwise direction to open the valve to the full open position (directional arrows are provided on the tool). Opening the valve to the full open position will aid in the refrigerant reclamation and evacuation processes.

Following the above procedure, reapply the EEV stator coil and retaining nut. Upon powering the unit back up, the control board will automatically drive the EEV back to the fully shut position, and then back to the 20% open position prior to starting the compressor back up. Once the compressor starts, the control board will again modulate the EEV position to control the system superheat.

**System Pressures**

To view system pressure and temperatures during this process:

1. From the Status screen, press UP or DOWN key until Quick Menu displays Unit Information icon (  ). Press ENTER key.
2. Press UP or DOWN keys to scroll to **EEV 1 Circuit** and **EVD 1 Compressor** screens.
3. Reference the **Pressures** and **Temperatures** on **EVD 1 Compressor** and the **Superheat** and **Subcooling** on **EEV 1 Circuit**.

**Additional EEV Alarms**

**Low Superheat Alarm**

This alarm will become active when the calculated superheat goes below 5°F. This alarm will clear itself when the condition is no longer present.

This alarm cannot be adjusted.

**Indoor Airflow**

**Indoor Airflow Components**

**Blower**

The unit is equipped with a blower that is driven by an electronically commutated motor (ECM). This blower is controlled by a 0-10v signal provided from the controller. This 0-10v signal is converted to a PWM signal with an adapter. This blower uses a 10" diameter wheel operating between 250-1400 rpm.

The blower output can be put into an override mode for verification or troubleshooting. To put the blower into override:

1. Press MENU key to go to the Main Menu screen.
2. Press UP or DOWN keys and ENTER key to enter TECHNICIAN password 1313.
3. Press UP or DOWN keys to scroll to **I/O Config**; press ENTER key.

4. Press UP or DOWN keys to scroll to **Blower Fan (C13)**; press ENTER key.
5. Press ENTER key to scroll to **Blower OV Speed** (see Figure 15).
6. Press UP or DOWN keys to adjust the speed to the desired output (see Table 3).
7. Press ENTER key to scroll to **Override**.
8. Press UP or DOWN key to change **Disabled** to **Enabled**.
9. Press ENTER key to save.
10. Press the ESCAPE key several times to return to Main Menu screen.

**FIGURE 15**  
**Putting Blower Output into Override Mode**



**TABLE 3**  
**Blower Speeds**

Mode	Speed Percentage	Controller Output Volts	CFM
Freezestat Active	80.0	8.0 v	2260
High Sensible Full Load Cooling	75.0	7.5 v	2180
High Sensible Part Load Cooling	50.0	5.0 v	1705
Standard Full Load Cooling	55.0	5.5 v	1830
Standard Part Load Cooling	35.0	3.5 v	1335
Economizer Speed	45.0	4.5 v	1600
Heating	35.0	3.5 v	1335
Dehumidification Mode	35.0	3.5 v	1335

**TABLE 4**  
**Rated Airflow**

Nominal Rated CFM		Nominal Rated ESP
High	Low	
1800	1400	.10

**TABLE 5**  
**Indoor Blower Performance**

Speed	High		Low	
	Dry Coil	Wet Coil	Dry Coil	Wet Coil
ESP (Inch H2O)				
0.1	1885	1800	1470	1400

**TABLE 6**  
**Maximum ESP of Operation**  
**Electric Heat Only**

Model	Static Pressure*
-A0Z	.00"
-A05	.00"
-B0Z	.00"
-B06	.00"

\* Unit is rated for free blow non-ducted operation with SGR-5W Supply Grille and RGR-5W Return Grille.

#### **Blower Status Alarm**

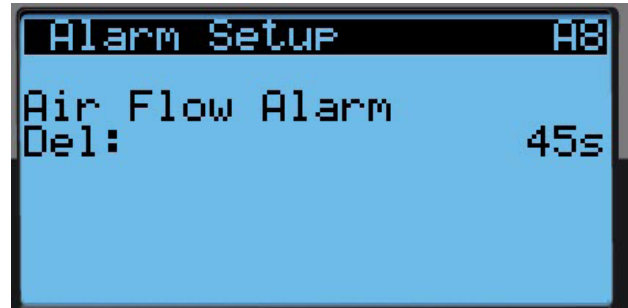
If the blower is commanded on and the fan status switch (differential pressure) has not indicated the fan is running within 45 seconds, the system will generate an alarm.

This alarm is just a notification and will clear itself when the conditions are no longer present.

To adjust the air flow alarm delay:

1. Press MENU key to go to the Main Menu screen.
2. Press UP or DOWN keys and ENTER key to enter USER password 2000.
3. Press UP or DOWN keys to scroll to **System Config**; press ENTER key.
4. Press UP or DOWN keys to scroll to **Alarm Setup (A8)**; press ENTER key.
5. Press ENTER key to scroll to **Air Flow Alarm Del** (see Figure 16).
6. Press UP or DOWN keys to change to the desired value.
7. Press ENTER key to save the value.

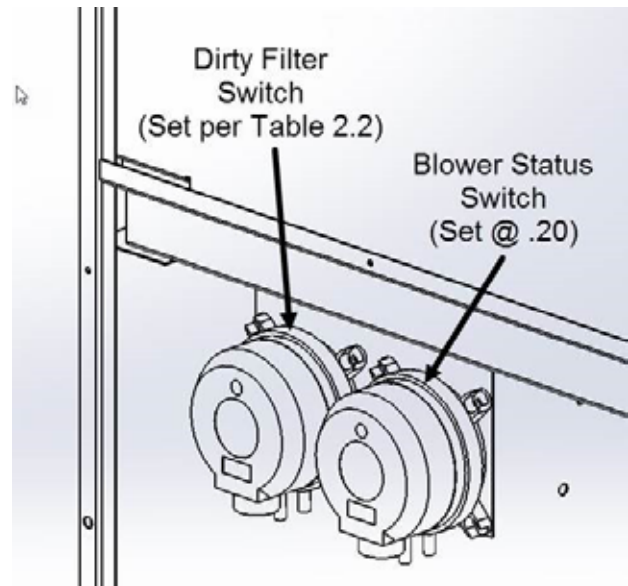
**FIGURE 16**  
**Adjusting Air Flow Alarm Delay**



#### **Differential Airflow Switch**

The unit is equipped with a differential pressure airflow switch to monitor the blower (see Figure 17). If the blower is turned on and the switch doesn't close to indicate there is differential pressure between the inlet and outlet of the blower, an alarm will be generated. The switch should be set at .20.

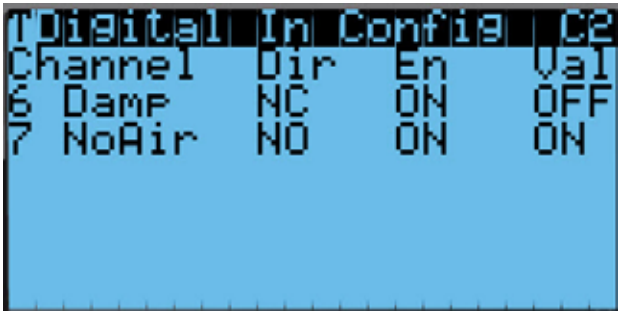
**FIGURE 17**  
**Dirty Filter Switch and Blower Status Switch**



Differential airflow status can be viewed by:

1. Press MENU key to go to the Main Menu screen.
2. Press UP or DOWN keys and ENTER key to enter TECHNICIAN password 1313.
3. Press UP or DOWN keys to scroll to **I/O Config**; press ENTER key.
4. Press UP or DOWN keys to scroll to **Digital In Config (C2)**; press ENTER key.
5. Reference **7 NoAir** row and **Val** column (see Figure 18 on page 16).

**FIGURE 18**  
**Verifying Differential Airflow Status**



**Filters**

The unit is equipped with two (2) 20" x 30" x 2" MERV 8 filters. The filters slide into position making them easy to service. The filters can be serviced from the outside by removing either the right or left filter access panel.

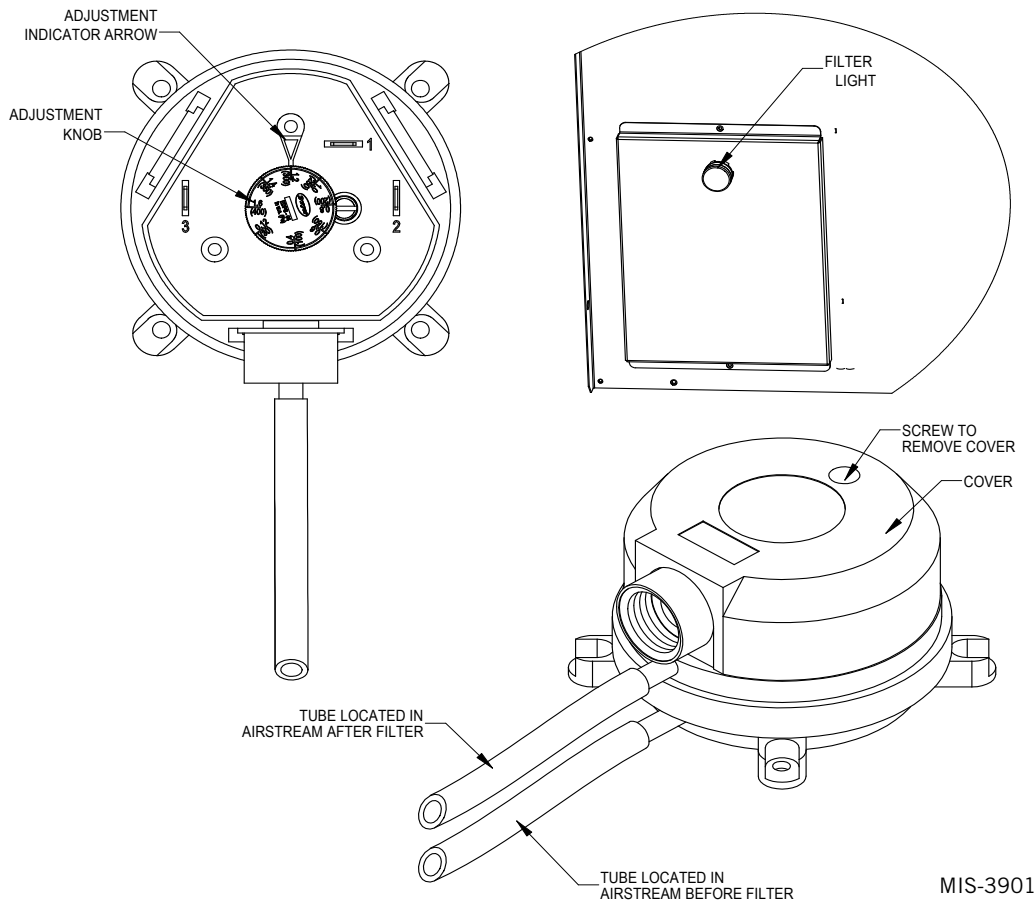
**Dirty Filter Switch**

These units are equipped with a differential pressure switch to indicate when the filter(s) needs to be replaced (see Figure 17). The dirty filter switch measures the pressure difference across the filter through silicone tubing routed to the blower and vent areas of the unit.

The switch circuit consists of a *normally open* filter pressure switch. The switch will open when the pressure differential goes above the setting indicated on the dial. When the pressure difference returns below the setting on the dial, the switch will close.

Adjustment of dirty filter switch may be necessary to ensure proper operation. See Figure 19 and Table 7 to aid in setting the filter switch to operate at different percentages of filter blockage.

**FIGURE 19**  
**Dirty Filter Switch and Filter Indicator Light**



MIS-3901



**TABLE 7**  
**Filter Switch Pressure Settings**

Unit	Filter Blockage %	0%	10%	20%	30%	40%	50%	60%	70%
HR58APA (Default) High S/T	Switch Static Setting	0.40	0.50	0.60	0.70	0.75	0.80	0.90	1.00
	Evaporator Airflow %	100%	98.7%	98.1%	97.5%	91.7%	81.3%	79.1%	78.6%
HR58APA Standard Airflow	Switch Static Setting	0.30	0.35	0.40	0.45	0.50	0.65	0.70	0.90
	Evaporator Airflow %	100%	99.8%	99%	98.5%	96.8%	89.9%	84%	82.2%

All units tested equipped with MERV 8 filters. Appropriate supply (SG) and return (RG) grilles installed during testing. Pressure switch adjustment may be necessary due to variations in filter type, installation and room pressure.

**Bard recommends the filter switch be set at 50% filter blockage or less. Higher settings may significantly hinder unit performance.**

**Dirty Filter Alarm**

The wall unit is equipped with a differential pressure switch input to the controller. When the switch indicates a dirty filter, the controller will generate an alarm. Once the condition is no longer present, the alarm will automatically clear. Additionally, an indicator light will be turned on with the alarm and turned off when the alarm clears.

The threshold of this alarm is adjusted by changing the settings on the switch (see Table 7).

**Filter Indicator Light**

These units are equipped with a 24v indicator light mounted on side of unit that displays the current status of the filter (see Figure 19). When the light is on, the filter needs to be replaced. Once the filter(s) has been changed, the indicator light will turn off.

**Freezestat**

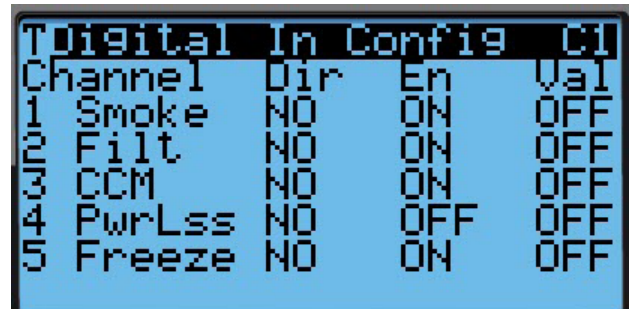
These units are equipped with a switch that monitors the temperature of the refrigerant line leaving the evaporator coil. To prevent the coil from freezing and potentially allowing liquid refrigerant from the evaporator to enter the compressor, the switch will open when the temperature at this sensor is between 26.5°F and 37.5°F and close again when the temperature is between 49.5°F and 64.5°F.

This switch can be verified by:

1. Press MENU key to go to the Main Menu screen.
2. Press UP or DOWN keys and ENTER key to enter TECHNICIAN password 1313.
3. Press UP or DOWN keys to scroll to **I/O Config**; press ENTER key.
4. Press UP or DOWN keys to scroll to **Digital In Config (C1)**; press ENTER key.
5. Reference **5 Freeze** row and **Val** column (see Figure 20).
6. This value will display ON when the freezestat has tripped and OFF when the freezestat is in its normal position.

**NOTE:** This input is automatically configured by the model number and cannot be enabled or disabled on this screen.

**FIGURE 20**  
**Verifying Freeze Switch Status**



**Freezestat Alarm**

When the freezestat digital input indicates a low temperature event has occurred for longer than 120 seconds, the controller will generate a freezestat alarm. This will then change the blower to high speed and turn off the compressor for a minimum of 300 seconds. The blower speed will return to normal once the alarm condition has been removed. The compressor will start again when the freezestat indicates no alarm and 300 seconds has passed. Once the condition is no longer present, the alarm will automatically clear.

To adjust the freezestat alarm delay:

1. Press MENU key to go to the Main Menu screen.
2. Press UP or DOWN keys and ENTER key to enter USER password 2000.
3. Press UP or DOWN keys to scroll to **System Config**; press ENTER key.
4. Press UP or DOWN keys to scroll to **Alarm Setup (A7)**; press ENTER key.
5. Press ENTER key to scroll to **FreezeStat Alarm Delay** (see Figure 21 on page 18).

- Press UP or DOWN keys to change to the desired value.
- Press ENTER key to save the value.

**FIGURE 21**  
Adjusting Freezestat Alarm Delay



## Indoor Airflow Operation

### Blower Speed Control

The blower is capable of changing speeds to best match the requirements of the system depending on which mode the system is in (see Table 3 on page 14).

The unit will automatically switch to the required speed for each mode. High sensible mode and dehumidification mode are both communicated separately from the LV. For more information on the high sensible command from LV, please see LV1000 Service Instructions 2100-673.

### Additional Indoor Airflow Alarms

#### Supply Air Temperature Alarm

When the supply air temperature sensor value is out of range (-41.0 to 303.0°F), the controller will generate a sensor failure alarm to indicate the sensor is not working properly.

This alarm is fixed and cannot be adjusted.

## Condenser Fan

### Condenser Fan Components

#### Condenser Fan

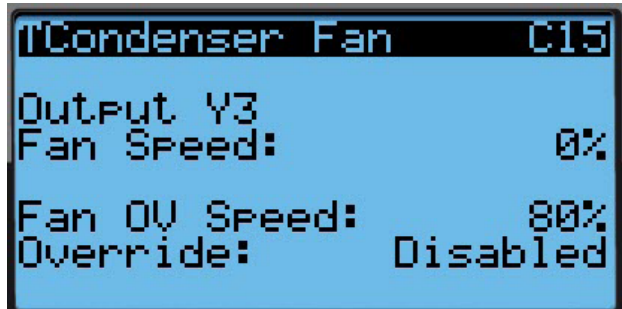
The unit is equipped with a condenser fan that is driven by an electronically commutated motor (ECM). This fan is controlled by a 0-10v signal provided from the controller. The fan operates between 100-1200 rpm.

To view the output of the condenser fan:

- Press MENU key to go to the Main Menu screen.
- Press UP or DOWN keys and ENTER key to enter TECHNICIAN password 1313.
- Press UP or DOWN keys to scroll to **I/O Config**; press ENTER key.

- Press UP or DOWN keys to scroll to **Condenser Fan (C15)**; press ENTER key.
- Reference **Fan Speed** parameter for the current output to the condenser fan (see Figure 22).

**FIGURE 22**  
Verifying Condenser Fan Output



If required, the condenser fan output can be manually set for 5 minutes for troubleshooting purposes.

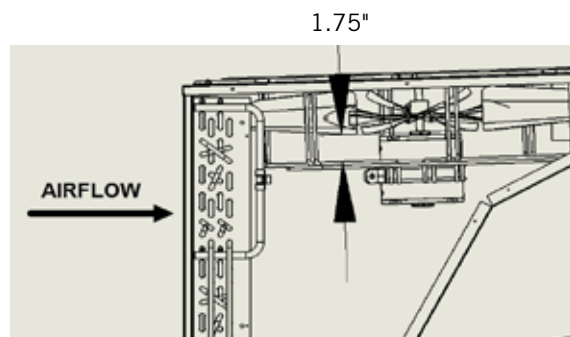
While looking at **Condenser Fan (C15)** screen:

- Press ENTER key to scroll to **Fan OV Speed** (see Figure 22).
- Press UP or DOWN keys to change the value to the desired override speed.
- Press ENTER key to save the value and move cursor to the **Override** parameter.
- Press UP or DOWN keys to change the value from **Disabled** to **Enabled**.
- The fan should now run at the selected speed. The output can be verified by again referencing the **Fan Speed** parameter.

The override will last for 5 minutes or until the **Override** parameter is set to **Disabled** again.

Due to design considerations of the condenser section of the wall unit, placement/clearance of the motor/fan blade is critical to heat dispersal. Should a change of motor or fan blade be necessary, see Figure 23 for proper clearance adjustment.

**FIGURE 23**  
Fan Blade Setting



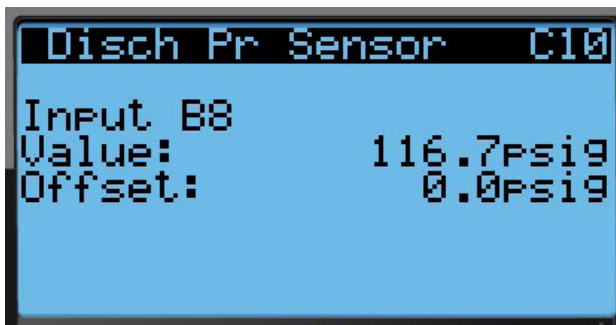
## High Pressure Transducer

The unit has a high side pressure transducer installed on the liquid line between the condenser and electronic expansion valve (EEV). The transducer is used for system monitoring of high side system pressures. This information is used to indicate when outdoor coil cleaning is necessary based on outdoor conditions and system pressures. The sensor is also used to adapt the condenser fan speed for high and low ambient conditions.

The high pressure input can be verified and adjusted by:

1. Press MENU key to go to the Main Menu screen.
2. Press UP or DOWN keys and ENTER key to enter TECHNICIAN password 1313.
3. Press UP or DOWN keys to scroll to **I/O Config**; press ENTER key.
4. Press UP or DOWN keys to scroll to **Disch Pr Sensor (C10)**; press ENTER key.
5. Verify the measurement displayed on screen is accurate (see Figure 24).
6. If the measurement needs to be adjusted, apply an offset value by pressing the ENTER key to scroll to **Offset**.
7. Press UP or DOWN keys to adjust the offset. The update will not take effect until the cursor is moved out of the offset parameter.
8. Once adjusted, the ESCAPE key several times to return to Main Menu screen.

**FIGURE 24**  
Adjusting High Pressure Input



### High Pressure Transducer Alarm

When the high pressure transducer sensor value is out of range (0-650 PSIG), the controller will generate a sensor failure alarm to indicate the sensor is not working properly.

This alarm is fixed and cannot be adjusted.

### Discharge Temperature Sensor

The unit is equipped with a liquid line temperature sensor to monitor the temperature of the liquid

refrigerant leaving the condenser and entering the EEV. The temperature is measured with a 10k ohm NTC thermistor.

The discharge temperature sensor can be verified and adjusted by:

1. Press MENU key to go to the Main Menu screen.
2. Press UP or DOWN keys and ENTER key to enter TECHNICIAN password 1313.
3. Press UP or DOWN keys to scroll to **I/O Config**; press ENTER key.
4. Press UP or DOWN keys to scroll to **Disch Temp Sensor (C3)**; press ENTER key.
5. Reference the **Value** to verify the temperature (see Figure 25).
6. If an offset needs to be applied, press ENTER key to scroll to **Offset**.
7. Press UP or DOWN keys to change the offset to desired value.
8. Press ENTER key to save.
9. Press ESCAPE key several times to return to Main Menu screen.

**FIGURE 25**  
Adjusting Discharge Temperature Input



### Condenser Fan Operation

#### Condenser Fan Speed Control

The condenser fan motor maintains its high efficiency across a wide operating range. The result is a significant reduction in energy use when the motor is run at reduced speeds. See Table 8 on page 20.

**TABLE 8  
Condenser Fan Speeds**

Mode	Speed %	Controller Output Volts	CFM
High Ambient	71 – 100	7.1 v – 10.0 v	2726 – 3703
Low Ambient	25 – 71	2.5 v – 7.1 v	1130 – 2726
Normal	71	7.1 v	2726

**High Pressure Control**

*Condenser Fan Speed*

When the discharge pressure reaches 590 PSI, the condenser fan will begin to speed up to attempt to bring the pressure back down. The speed will continue to ramp up until the discharge pressure reaches 630 PSI. At this point, the fan will be operating at full speed, moving as much air as possible.

*Second Stage Drop Out*

The second stage of cooling will be disabled when the discharge pressure reaches 620 PSI to reduce the required condenser airflow.

*High Pressure Cut Out*

See chart in Figure 26.

**Low Pressure Control**

When the discharge pressure reaches 375 PSI, the condenser fan will begin to slow down to attempt to

bring the pressure back up. The speed will continue to ramp down until the discharge pressure reaches 340 PSI. At this point, the fan will be operating at minimum speed, moving as little air as possible.

If the discharge pressure continues to go down to 250 PSI, the condenser fan will turn off. The fan will remain off with the compressor running until the pressure reaches 340 PSI. The fan will then turn back on at the minimum speed. The fan will continue to run at the minimum speed until the pressure drops again or starts to rise above the 340 PSI setpoint and begins to speed up again.

**Additional Condenser Fan Alarms**

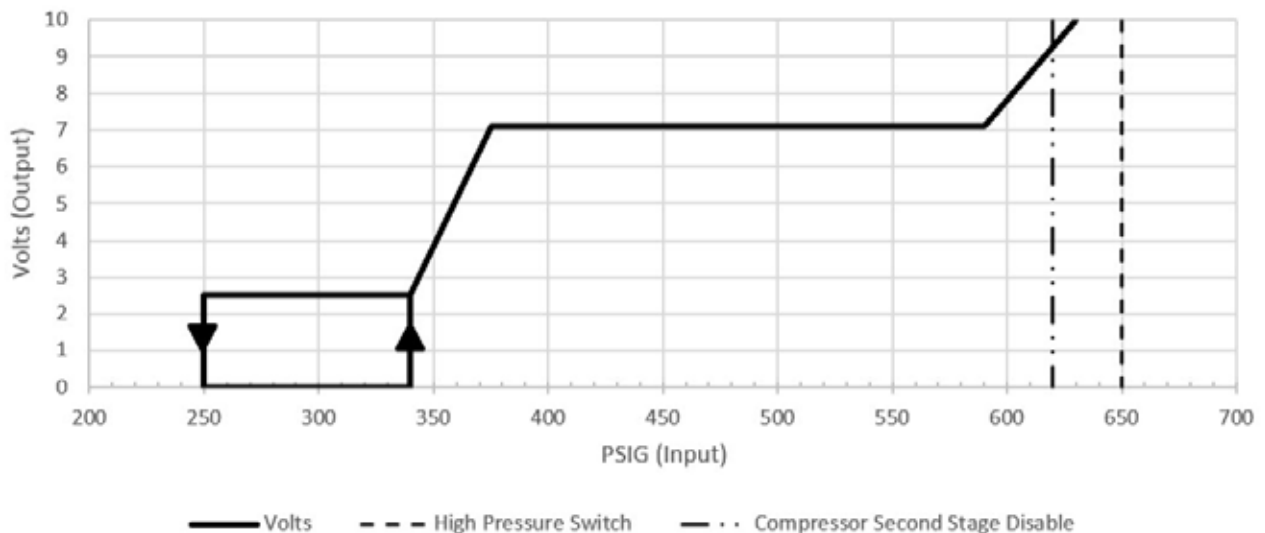
**Dirty Condenser Coil Alarm**

The unit will continuously monitor system conditions to determine if the condenser coil is dirty or blocked. If the system monitors three consecutive cooling cycles that indicate a dirty condenser coil, an alarm will be generated. This alarm is a notification and will automatically reset when conditions are no longer present. The end user has the ability to adjust how dirty the coil gets before an alarm is generated and how many consecutive cycles before the alarm is triggered.

To change these settings:

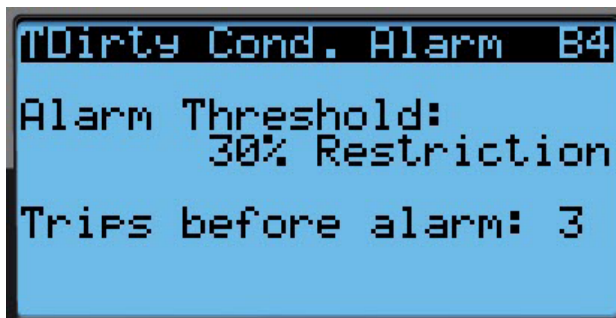
1. Press MENU key to go to the Main Menu screen.
2. Press UP or DOWN keys and ENTER key to enter TECHNICIAN password 1313.
3. Press UP or DOWN keys to scroll to **Adv System Config**; press ENTER key.
4. Press UP or DOWN keys to scroll to **Dirty Cond Alarm (B4)**; press ENTER key.

**FIGURE 26  
Pressure Control**



5. Press ENTER key to scroll to **Alarm Threshold** (see Figure 27).
6. Press UP or DOWN keys to adjust the % restriction to desired level.
7. Press ENTER key to save value and move the cursor to **Trips before alarm**.
8. Press UP or DOWN keys to change the **Trips before alarm** to the desired value.
9. Press ENTER key to save.
10. Press ESCAPE key several times to return to Main Menu screen.

**FIGURE 27**  
**Adjusting Dirty Condenser Coil Alarm Settings**



## Compressor

### Compressor Components

#### Compressor

##### *Three Phase Scroll Compressor Start Up Information*

Scroll compressors, like several other types of compressors, will only compress in one rotational direction. Direction of rotation is not an issue with single phase compressors since they will always start and run in the proper direction.

However, three phase compressors will rotate in either direction depending upon phasing of the power. Since there is a 50-50 chance of connecting power in such a way as to cause rotation in the reverse direction, verification of proper rotation must be made. Verification of proper rotation direction is made by observing that suction pressure drops and discharge pressure rises when the compressor is energized. Reverse rotation also results in an elevated sound level over that with correct rotation, as well as substantially reduced current draw compared to tabulated values.

Verification of **proper rotation** must be made at the time the equipment is put into service. If improper rotation is corrected at this time, there will be no negative impact on the durability of the compressor. However, reverse operation for over 1 hour may have a negative impact on the bearing due to oil pump out.

**NOTE:** *If compressor is allowed to run in reverse rotation for an extended period of time, the compressor's internal protector will trip.*

All three phase compressors are wired identically internally. As a result, once the correct phasing is determined for a specific system or installation, connecting properly phased power leads to the same Fusite terminal should maintain proper rotation direction.

The direction of rotation of the compressor may be changed by reversing any two line connections to the unit.

#### **Compressor Control Module (CCM)**

The compressor control module is a low voltage monitoring device necessary to monitor power and indicate a low incoming voltage situation caused by inadequate shore power or generator operation. The monitoring device protects the unit against compressor contactor "chatter" and reverse compressor rotation during these situations.

Compressor protection device has an adjustable 30-second to 5-minute timer (red-dial). This module features a delay-on-make for initial start up (or anytime power is interrupted) for a minimum 2 minutes plus 10% of the red-dial setting. There is no delay during routine operation of the unit. The compressor control module also monitors the high pressure switch, and will allow one automatic retry (after soft lockout delay) before disabling the compressor in a hard lockout (requires manual reset). If hard lockout does occur, the ALR terminal on the CCM will become active with 24v, which will power the high pressure relay within the wall unit. The relay contacts are monitored by the unit controller. If the CCM indicates an alarm to the wall unit controller, an alarm will be generated and the compressor will be locked out by the controller.

**NOTE:** *The controller will remove cooling call on the Y terminal of the CCM, resetting it almost instantly. The compressor remains locked out by the controller until manually cleared.*

Switch is jumpered in this application. Instead, the low pressure transducer is used for low pressure monitoring.

#### **High Pressure Safety Switch**

All units have a high pressure switch as a safety device. This device will open when pressure in the system reaches 650 PSIG. The sensor is directly connected to the dedicated compressor control module. This module will disable any call for cooling if the pressure is above this limit. If tripped, the high pressure switch can be reset by turning the output off and then back on again.

#### **Refrigerant High Pressure Alarm**

When the wall unit receives a signal from the compressor control module (CCM) indicating a high pressure event, the wall unit will generate an alarm.



Upon receiving the alarm, the wall unit will remove the “Y” call from the CCM, resetting the status of the CCM. The alarm will stay present on the wall unit until manually cleared.

In addition to the CCM, the discharge pressure transducer is used to prevent a high pressure event. When the discharge pressure is above the discharge pressure alarm setpoint (set 30 pounds below high pressure switch, which is 650), the system will disable stage 2 of mechanical cooling.

### Phase Monitor

Used only on three phase equipment, the phase monitor is a compressor protection device that will prohibit operation of the compressor if the device senses a possible reverse-rotation situation due to incorrect phasing. On a call for compressor (and only compressor), the device will check incoming phase, check for severe voltage imbalance and check for proper frequency. Under nominal conditions, a green LED light will show on the face of the monitor. If there is improper phasing, voltage imbalance or frequency deviation, the device will show a red LED light and prohibit compressor operation.

If a fault condition occurs, reverse two of the supply leads to the unit. **Do not reverse any of the unit factory wires as damage may occur.**

### Compressor Operation

The compressor will be enabled when the unit (in stand alone mode) or LV provide a cooling stage 1 call. The compressor call from the controller has several delays that may affect the start or stop time of the compressor in regards to the cooling demand. The compressor has a minimum on time of 180 seconds to prevent short cycling the compressor. The compressor also has a minimum off time of 120 seconds to prevent start ups before the pressure in the refrigeration system equalizes. When the second stage is engaged, it also has a minimum run time of 120 seconds to allow the system to stabilize before returning to single stage or shutting down.

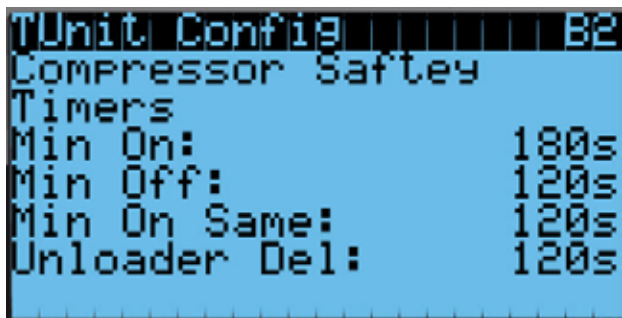
These delays can be changed by:

1. Press MENU key to go to the Main Menu screen.
2. Press UP or DOWN keys and ENTER key to enter TECHNICIAN password 1313.
3. Press UP or DOWN keys to scroll to **Adv System Config**; press ENTER key.
4. Press UP or DOWN keys to scroll to **Unit Config (B2)**; press ENTER key.
5. Press ENTER key to scroll to **Min On, Min Off, Min On Same, Unloader Del or Address Delay** (see Figure 28).
6. Press UP or DOWN keys to change the value.

7. Press ENTER key to save value and move the cursor to next parameter or top of screen.
8. Press ESCAPE key several times to return to Main Menu screen.

The address-based delay only applies to the wall unit when in stand alone mode. The controller will delay the unit compressor based on the value entered on screen B2 multiplied by the unit address. This is intended to keep multiple units from starting their compressors at the same time when there is a quick change in the load. When connected to the LV, this is taken care of by LV logic.

**FIGURE 28**  
**Adjusting Compressor Delays**



### Additional Compressor Alarms

#### Refrigerant Low Pressure Alarm

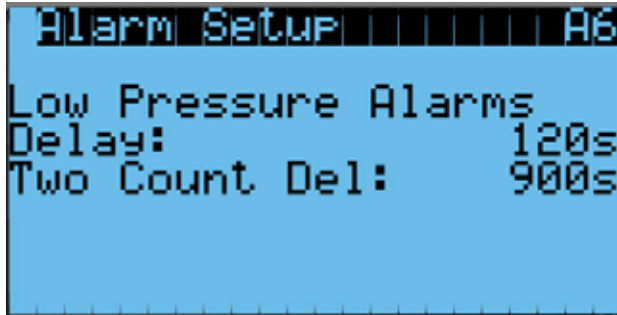
When the low pressure transducer indicates a pressure value less than the low pressure alarm setpoint of 40 PSIG and there is an active call for cooling, the controller will disable the compressor (after a 180-second delay). **NOTE: The second call will be delayed based on the delay off value mentioned in the compressor section.** The controller will try to run the refrigeration system two (2) times within 900 seconds before the alarm will lock the compressor out. This alarm needs to be manually cleared before compressor operation will resume.

To adjust the low pressure alarm settings:

1. Press MENU key to go to the Main Menu screen.
2. Press UP or DOWN keys and ENTER key to enter USER password 2000.
3. Press UP or DOWN keys to scroll to **System Config**; press ENTER key.
4. Press UP or DOWN keys to scroll to **Alarm Setup (A6)**; press ENTER key.
5. Press ENTER key to scroll to **Delay** to adjust how long the compressor waits before turning the compressor off (see Figure 29).
6. Press UP or DOWN keys to adjust the time delay.
7. Press ENTER key to scroll to **Two Count Del**.

8. Press UP or DOWN keys to adjust the delay value.
9. Press ENTER key to save.
10. Press the ESCAPE key several times to return to Main Menu screen.

**FIGURE 29**  
Adjusting Low Pressure Alarm Settings



## Economizer

### Economizer Components

#### Actuator

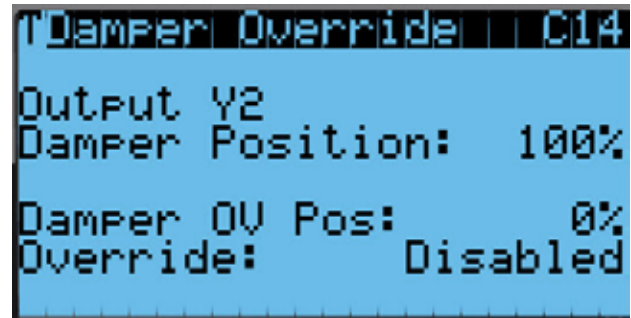
The actuator rotates up to 90° based on a 2-10v signal sent to it by the controller. The actuator is rated at 44 lb-in and is spring return when power is lost. This component is what opens and closes the damper blade.

To verify the output from the controller to the actuator:

1. Press MENU key to go to the Main Menu screen.
2. Press UP or DOWN keys and ENTER key to enter TECHNICIAN password 1313.
3. Press UP or DOWN keys to scroll to **I/O Config**; press ENTER key.
4. Press UP or DOWN keys to scroll to **Damper Override (C14)**; press ENTER key.
5. Reference the **Damper Position** for the current output to the damper (see Figure 2.30).
6. To override the current position, press ENTER key to scroll to **Damper OV Pos**.
7. Press UP or DOWN keys to change the value to the desired output.
8. Press ENTER key to save the value and move cursor to **Override**.
9. Press UP or DOWN keys to change the value from **Disabled** to **Enabled**.
10. The **Damper Position** will update with the new override value and the damper will travel to that position.

**NOTE:** This override will last for 5 minutes or until the **Override** is changed back to **Disabled**.

**FIGURE 30**  
Damper Override



#### Dust Sensor

The unit has a dust sensor installed near the outdoor air inlet. The dust sensor checks for excessive particulates in the outdoor air, and will close the economizer if the dust is excessive. The sensor uses a PWM signal converted to 0-5v output to the controller.

To ensure proper performance, cleaning may be required. Vacuuming or blowing the dust off the sensor with forced air is recommended. **Avoid inserting any objects into the sensor.**

The dust sensor can be verified by:

1. Press MENU key to go to the Main Menu screen.
  2. Press UP or DOWN keys and ENTER key to enter TECHNICIAN password 1313.
  3. Press UP or DOWN keys to scroll to **I/O Config**; press ENTER key.
  4. Press UP or DOWN keys to scroll to **Dust Sensor (C8)**; press ENTER key.
  5. Reference the **Value** for the current sensor reading (see Figure 31 on page 24).
  6. To apply an offset to the current reading, press ENTER key to scroll to **Offset**.
  7. Press UP or DOWN keys to adjust the value to the desired value.
  8. Press ENTER key to save the value and move cursor to next parameter.
- NOTE:** The sensor can be disabled if required for troubleshooting.
9. With the cursor on the **Enable** parameter, press UP or DOWN keys to change the value from **ON** to **OFF**.
  10. Press ENTER key to save.

**FIGURE 31**  
Dust Sensor



**Dust Sensor Failure Alarm**

When the sensor reads a value that is outside of the acceptable 0 to 100% RH range, an alarm will be generated indicating the sensor has failed. This alarm is just a notification and will not disable any other features on the controller.

This alarm is fixed and cannot be adjusted.

**Dust Limit Alarm**

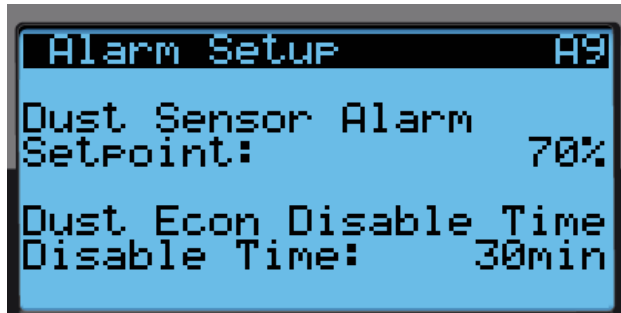
The controller has adjustable software setpoints (default to 80%) to indicate dust levels are too high and disable the economizer operation for 30 minutes. This alarm is not communicated to the NOC. Once the conditions are no longer present, the alarm will automatically clear.

To adjust the dust sensor alarm setpoint:

1. Press MENU key to go to the Main Menu screen.
2. Press UP or DOWN keys and ENTER key to enter USER password 2000.
3. Press UP or DOWN keys to scroll to **System Config**; press ENTER key.
4. Press UP or DOWN keys to scroll to **Alarm Setup (A9)**; press ENTER key.
5. Press ENTER key to scroll to **Setpoint** (see Figure 32).
6. Press UP or DOWN keys to change to the desired value.
7. Press ENTER key to save the value.

**NOTE:** When the temperature outside is measured at or below 0°F, the dust sensor alarm will be disabled to allow economizer operation. This is done because the compressor is disabled below 0°F and the system would not have the capability to cool.

**FIGURE 32**  
Adjusting Dust Sensor Alarm Setpoint



**Damper Blade**

The system utilizes three damper blades used to bring in outdoor air and exhaust space air for economizer operation. The damper blades are made of sheet metal and are integrated into the equipment.

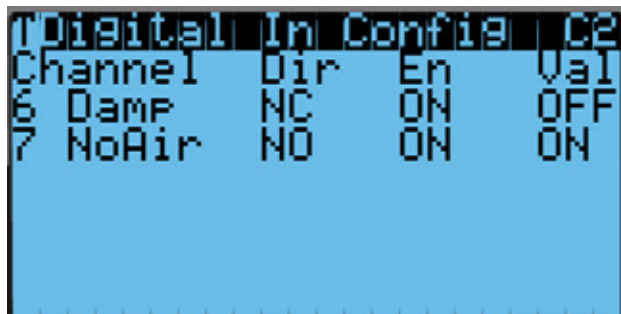
**Damper Switch**

The economizer utilizes a magnetic switch to determine if the damper is operating correctly. This switch will be closed when the damper is closed and open when the damper is open.

To verify the status of the switch:

1. Press MENU key to go to the Main Menu screen.
2. Press UP or DOWN keys and ENTER key to enter TECHNICIAN password 1313.
3. Press UP or DOWN keys to scroll to **I/O Config**; press ENTER key.
4. Press UP or DOWN keys to scroll to **Digital In Config (C2)**; press ENTER key.
5. Reference the value located at **6 Damp** row and **Val** column (see Figure 33).
6. The input will display **ON** when the damper is closed (reflecting closed circuit on damper switch) and will display **OFF** when the damper is open (reflecting open circuit on damper switch).

**FIGURE 33**  
Damper Switch





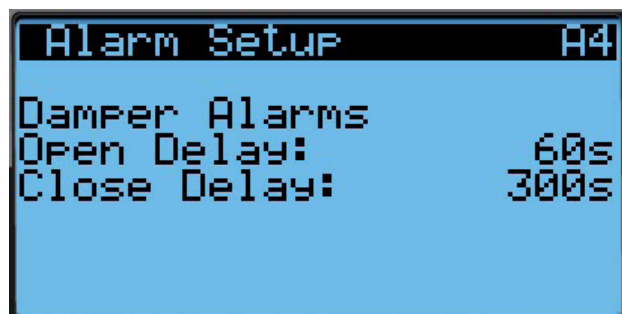
### ***Damper Failed to Open Alarm***

When the controller commands the economizer damper actuator to a position other than 0% and the damper switch indicates the damper is not open, after a delay of 20 seconds the controller will generate a damper failed to open alarm. This alarm is just a notification and will not disable any features on the controller.

To adjust the damper failed to open delay:

1. Press MENU key to go to the Main Menu screen.
2. Press UP or DOWN keys and ENTER key to enter USER password 2000.
3. Press UP or DOWN keys to scroll to **System Config**; press ENTER key.
4. Press UP or DOWN keys to scroll to **Alarm Setup (A4)**; press ENTER key.
5. Press ENTER key to scroll to **Open Delay** (see Figure 34).
6. Press UP or DOWN keys to change to the desired value.
7. Press ENTER key to save the value.

**FIGURE 34**  
**Adjusting Damper Alarm Delay**



### ***Damper Failed to Close Alarm***

When the controller commands the economizer damper actuator to the 0% position and the damper switch indicates the damper is not closed, after a delay of 300 seconds the controller will generate a damper failed to close alarm. This alarm is just a notification and will not disable any features on the controller.

To adjust the damper failed to close delay:

1. Press MENU key to go to the Main Menu screen.
2. Press UP or DOWN keys and ENTER key to enter USER password 2000.
3. Press UP or DOWN keys to scroll to **System Config**; press ENTER key.
4. Press UP or DOWN keys to scroll to **Alarm Setup (A4)**; press ENTER key.

5. Press ENTER key to scroll to **Close Delay** (see Figure 34).
6. Press UP or DOWN keys to change to the desired value.
7. Press ENTER key to save the value.

### **Outdoor Temperature and Humidity Combination Sensor**

The unit is equipped with a combination outdoor temperature and humidity sensor to monitor outdoor conditions for the economizer operation. The temperature is measured with a 10k ohm NTC thermistor. The humidity is measured with a humidity sensor that outputs a 4-20mA signal to the controller.

The outdoor temperature can be verified by:

1. Press MENU key to go to the Main Menu screen.
2. Press UP or DOWN keys and ENTER key to enter TECHNICIAN password 1313.
3. Press UP or DOWN keys to scroll to **I/O Config**; press ENTER key.
4. Press UP or DOWN keys to scroll to **Outdoor Air Sensor (C4)**; press ENTER key.
5. Reference the **Value** to see the input of the sensor (see Figure 35).
6. To apply an offset, press ENTER key to scroll to **Offset**.
7. Press UP or DOWN keys to change to the desired value.
8. Press ENTER key to save the value.

**FIGURE 35**  
**Outdoor Air Sensor**



The outdoor humidity can be verified by:

1. Press MENU key to go to the Main Menu screen.
2. Press UP or DOWN keys and ENTER key to enter TECHNICIAN password 1313.
3. Press UP or DOWN keys to scroll to **I/O Config**; press ENTER key.
4. Press UP or DOWN keys to scroll to **Outdoor Hum Sensor (C7)**; press ENTER key.

5. Reference the **Value** to see the input of the sensor (see Figure 36).
6. To apply an offset, press ENTER key to scroll to **Offset**.
7. Press UP or DOWN keys to change to the desired value.
8. Press ENTER key to save the value.

**FIGURE 36**  
Outdoor Humidity Sensor



#### **Outdoor Temperature Sensor Failure Alarm**

When the sensor reads a value that is outside of the acceptable -41 to 303.0° range, an alarm will be generated indicating the sensor has failed. This alarm condition will disable the economizer.

This alarm is fixed and cannot be adjusted.

#### **Outdoor Humidity Sensor Failure Alarm**

When the sensor reads a value that is outside of the acceptable 0 to 100% RH range, an alarm will be generated indicating the sensor has failed. This alarm condition will disable the economizer when the mode is set to temperature and humidity or enthalpy.

This alarm is fixed and cannot be adjusted.

#### **Supply Temperature Sensor**

The unit is equipped with a supply air temperature sensor to monitor the leaving air temperature of the unit. The temperature is measured with a 10k ohm NTC thermistor.

The supply air temperature can be verified by:

1. Press MENU key to go to the Main Menu screen.
2. Press UP or DOWN keys and ENTER key to enter TECHNICIAN password 1313.
3. Press UP or DOWN keys to scroll to **I/O Config**; press ENTER key.
4. Press UP or DOWN keys to scroll to **Supply Air Sensor (C6)**; press ENTER key.
5. Reference the **Value** to see the input of the sensor (see Figure 37).

6. To apply an offset, press ENTER key to scroll to **Offset**.
7. Press UP or DOWN keys to change to the desired value.
8. Press ENTER key to save the value.

**FIGURE 37**  
Supply Air Sensor



#### **Supply Temperature Sensor Failure Alarm**

When the sensor reads a value that is outside of the acceptable -41.0 to 303.0° range, an alarm will be generated indicating the sensor has failed.

This alarm is fixed and cannot be adjusted.

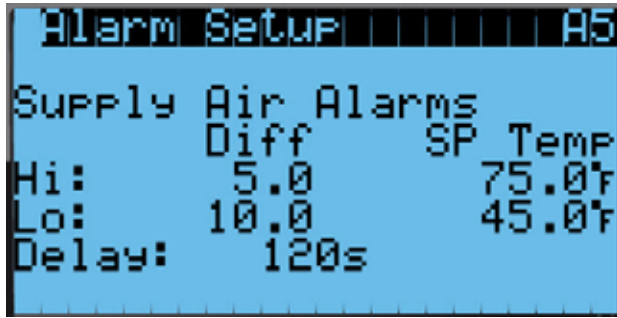
#### **High Supply Air Temperature Alarm**

When the supply air temperature measurement is above the outdoor air temperature setpoint (70°F) for the economizer to be enabled for 120 seconds, an alarm will be generated and the economizer will be disabled until the cooling call has been removed. This alarm will automatically reset once the economizer is no longer disabled.

To change the high supply air temperature alarm:

1. Press MENU key to go to the Main Menu screen.
2. Press UP or DOWN keys and ENTER key to enter USER password 2000.
3. Press UP or DOWN keys to scroll to **System Config**; press ENTER key.
4. Press UP or DOWN keys to scroll to **Alarm Setup (A5)**; press ENTER key.
5. Press ENTER key to scroll to **Hi and Diff** value (see Figure 38).
6. Press UP or DOWN keys to change the differential to the desired value.
7. Press ENTER key to save and scroll to the next parameter.

**FIGURE 38**  
**Adjusting Supply Air Temperature Differential**



**Low Supply Air Temperature Alarm**

When the supply air temperature is below 45°F for 120 seconds, an alarm will be generated and the economizer will be disabled until the cooling call has been removed. This alarm will automatically reset when the economizer is no longer disabled.

To change the low supply air temperature alarm:

1. Press MENU key to go to the Main Menu screen.
2. Press UP or DOWN keys and ENTER key to enter USER password 2000.
3. Press UP or DOWN keys to scroll to **System Config**; press ENTER key.
4. Press UP or DOWN keys to scroll to **Alarm Setup (A5)**; press ENTER key.
5. Press ENTER key to scroll to **Lo and Diff** value (see Figure 38).
6. Press UP or DOWN keys to change the differential to the desired value.
7. Press ENTER key to save value and scroll to **Delay**.
8. Press UP or DOWN keys to adjust the delay value.

**NOTE:** This delay is also applied to the high supply air temperature alarm.

9. Press ENTER key to save.

**Economizer Operation**

The economizer has four types of operation. The first mode is "None" where the economizer is never utilized. The second mode is "Dry Bulb Only" where the outdoor temperature is the only consideration for economizer use on a cooling call. The third mode is "Temperature and Humidity" where the outdoor temperature and humidity are considered for economizer use on a cooling call. The fourth mode is "Enthalpy" where the outdoor temperature, humidity and calculated dew point are considered for economizer operation on a cooling call.

To change the economizer type:

1. Press MENU key to go to the Main Menu screen.

2. Press UP or DOWN keys and ENTER key to enter USER password 2000.
3. Press UP or DOWN keys to scroll to **System Config**; press ENTER key.
4. Press UP or DOWN keys to scroll to **Economizer Setup (A2)**; press ENTER key.
5. Press ENTER key to scroll to **Type** (see Figure 39).
6. Press UP or DOWN keys to change the **Type** desired value to **None**, **Dry Bulb**, **TempHum** or **Enthalpy**.
7. Press ENTER key to save the value and scroll to the next parameter.

**FIGURE 39**  
**Economizer Setup**



**NOTE:** The following parameters are for the temperature consideration for economizer use. Applies to **Dry Bulb**, **TempHum** and **Enthalpy** type.

8. The cursor should now be on the **Outdoor Set** parameter.
9. Press UP or DOWN keys to change the parameter to the desired value.
10. Press ENTER key to save the value and scroll to the next parameter.
11. The cursor should now be on **Off Diff** parameter.
12. Press UP or DOWN keys to change the parameter to the desired value.
13. Press ENTER key to save the value and move to the next parameter.
14. The cursor is now on the **Mixed FC Set** parameter.
15. Press UP or DOWN keys to change the parameter to the desired value.
16. Press ENTER key to save the value.
17. Press the DOWN key to navigate to the **A3** screen.

**NOTE:** This screen will not display if economizer mode is set to **Dry Bulb** or **None**. Also, the contents of the screen will change when type is set to **Enthalpy** (see Figure 40 on page 28) as compared to when type is set to **TempHum**

(see Figure 41). The following menu shows the **Enthalpy** content which also contains parameters that would be shown on **TempHum**.

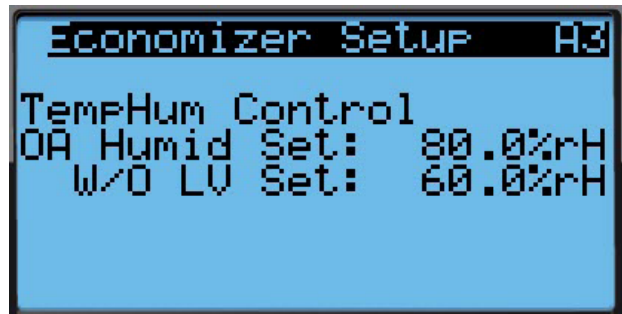
18. Press ENTER key to scroll to **OA Humid Set** (see Figure 40).
19. Press UP or DOWN keys to change the humidity setpoint to desired value.
20. Press ENTER key to save the value and scroll to **W/O LV Set**.
21. Press UP or DOWN keys to change the humidity setpoint for stand alone mode to desired value.
22. Press ENTER key to save the value and scroll to **OA Dew Pt Set**.
23. Press UP or DOWN keys to adjust the dew point setpoint for economizer operation to the desired value.
24. Press ENTER key to save the value and scroll to **Off Diff**.
25. Press UP or DOWN keys to adjust the differential where dew point no longer allows economizer operation.
26. Press ENTER key to save the value and scroll to parameter **Delay**.
27. Press UP or DOWN keys to adjust the delay before the dew point consideration will allow the economizer to operate.
28. Press ENTER key to save the value.
29. Press ESCAPE key several times to return to Main Menu screen.

See Table 9 for default settings for economizer operation.

**FIGURE 40**  
**Economizer Setup – Enthalpy Control**



**FIGURE 41**  
**Economizer Setup – TempHum Control**



If the economizer is activated during a cooling call using any of the previously mentioned modes, a 0-10v signal will be sent to the actuator. The actuator will then open and close the damper blades to maintain a mixed air temperature of 55°F. When the mixed air temperature increases the damper will open and when the mixed air temperature decreases the damper will close.

**TABLE 9**  
**Economizer Default Settings**

Mode		Consideration	Economizer Available for Cooling	Economizer Not Available for Cooling	
Temp Only	Temp & Humidity	Enthalpy*	Temperature	When the outdoor air temperature is below 70°F	When the outdoor air temperature is above 75°F
			Humidity	<b>LV Online:</b> When the outdoor humidity is below 80%	<b>LV Online:</b> When the outdoor humidity is above 80%
				<b>LV Offline:</b> When the outdoor humidity is below 60%	<b>LV Offline:</b> When the outdoor humidity is above 60%
		Dew Point	When the outdoor dew point is below 55°F	When the outdoor dew point is above 60°F	

\* In Enthalpy mode, outdoor temperature, humidity and calculated dew point are all considered for economizer operation.

The economizer may be disabled by the LV if the system determines it needs to enter dehumidification mode. More information about the dehumidification sequence can be found on page 12 and in LV1000 Service Instructions 2100-673. In addition to dehumidification mode, the economizer may be disabled for 30 minutes (adjustable) if the dust sensor indicates the outdoor air is not acceptable for cooling. After the time has expired and on a call for cooling, the economizer will open again to sample the air. The unit will either return to normal operation or remain locked out for another 30 minutes.

## **Emergency Ventilation Mode**

If the shelter temperature is above the high temperature alarm 2 on the LV, the unit will be commanded into emergency ventilation mode. In this mode, the unit will open the economizer to 100%. The compressor may run during this mode. This will stay active until the LV returns the unit to normal operation. This mode is only available when connected to the LV.

## **Model/Serial Number Configuration**

The system will automatically configure some settings based on the model number input into the unit. The model and serial number are entered at the factory. During a program update, the model and serial number may be lost and need to be re-entered.

The unit will look at model number character number 10 to determine if the economizer should be disabled. If the character is a E or e, the economizer operation will be disabled.

The unit will look at model number characters 8 and 9 to determine how many heat stages are available. If the characters are OZ, Oz, MZ, Mz, mZ or mz, the unit will be set to 0 stages of heat. If the characters are 05, m5 or M5, the unit will be set to 1 stage of heat.

## **Electric Heat Option**

### **Electric Heat Components**

#### **Electric Heating Element**

The unit is optionally equipped with a 5kw heat strip. The heat strip is located next to the blower assembly and uses resistive heat.

#### **Thermal Overload**

The heater assembly has a thermal overload wired in series with the heating element. This device has a cycling limit which opens at 130°F and resets at 80°F. The limit is also equipped with a redundant thermal fuse that will open at 150°F.

### **Electric Heat Operation**

The heat strip will be activated on a call for heat. This call can be generated by the LV or the wall unit operating in stand alone mode.

## **Bard Guard Anti-Theft System Option**

The unit has the option to be shipped from the factory with a low pressure switch, panel sensors and a speaker. These devices are used with the Bard Guard BG1000 anti-theft controller to provide an anti-theft measure. These sensors and switch form a loop that when connected to the BG1000 controller will cause the system to go into alarm if any of the front panels or coil assemblies are removed without being disarmed. The speaker provides an audible alert that the system is being tampered with. The Bard Guard anti-theft control sensor connection is wired to terminals 7 and 8 on the wall unit. The speaker connection is wired to terminals 5 and 6 on the wall unit. See the BG1000 Installation Instructions 2100-672 for directions on connecting the wall units to the BG1000 controller.

## **Smoke Detector Option**

The unit is equipped with an input that requires a dry contact. This will disable unit operation and is intended to be used with a smoke detector (not supplied). When this input indicates a smoke event, the system will be shut down. The alarm will automatically clear when the alarm condition is no longer present.

## **Inverter Option**

The inverter is only used in applications where a generator is not present and the units must run during a power loss. The inverter will detect when power is lost to the wall unit and automatically turn on. The inverter will convert 48 vdc to 230 vac. It will also energize a power loss relay that will only allow the blower and economizer to run while powering the controller. A relay output from the inverter will also communicate to the controller that a power loss event has occurred. This data point will be communicated back to the LV1000 (powered by -48 vdc all the time). This variable will then be available as a relay output for remote communication applications or communicated through the board Ethernet port for integration into building management system. The units will continue to run in economizer-only operation until power has been restored or the battery power has been depleted.



# REFRIGERANT INFORMATION

## NOTICE

These units require R-410A refrigerant and polyol ester oil.

### General

1. Use separate service equipment to avoid cross contamination of oil and refrigerants.
2. Use recovery equipment rated for R-410A refrigerant.
3. Use manifold gauges rated for R-410A (800 PSI/250 PSI low).
4. R-410A is a binary blend of HFC-32 and HFC-125.
5. R-410A is nearly azeotropic—similar to R-22 and R-12. Although nearly azeotropic, charge with liquid refrigerant.
6. R-410A operates at 40-70% higher pressure than R-22, and systems designed for R-22 cannot withstand this higher pressure.
7. R-410A has an ozone depletion potential of zero, but must be reclaimed due to its global warming potential.
8. R-410A compressors use polyol ester oil.
9. Polyol ester oil is hygroscopic; it will rapidly absorb moisture and strongly hold this moisture in the oil.
10. A liquid line dryer must be used—even a deep vacuum will not separate moisture from the oil.
11. Limit atmospheric exposure to 15 minutes.
12. If compressor removal is necessary, always plug compressor immediately after removal. Purge with small amount of nitrogen when inserting plugs.

### Topping Off System Charge

If a leak has occurred in the system, Bard Manufacturing recommends reclaiming, evacuating (see criteria above) and charging to the nameplate charge. If done correctly, topping off the system charge can be done without problems.

With R-410A, there are no significant changes in the refrigerant composition during multiple leaks and recharges. R-410A refrigerant is close to being an azeotropic blend (it behaves like a pure compound or single component refrigerant). The remaining refrigerant charge in the system may be used after leaks have

occurred. “Top-off” the charge by utilizing the pressure charts on the inner control panel cover as a guideline.

**REMEMBER:** When adding R-410A refrigerant, it must come out of the charging cylinder/tank as a liquid to avoid any fractionation and to insure optimal system performance. Refer to instructions for the cylinder that is being utilized for proper method of liquid extraction.

### Safety Practices

1. Never mix R-410A with other refrigerants.
2. Use gloves and safety glasses. Polyol ester oils can be irritating to the skin, and liquid refrigerant will freeze the skin.
3. Never use air and R-410A to leak check; the mixture may become flammable.
4. Do not inhale R-410A—the vapor attacks the nervous system, creating dizziness, loss of coordination and slurred speech. Cardiac irregularities, unconsciousness and ultimately death can result from breathing this concentration.
5. Do not burn R-410A. This decomposition produces hazardous vapors. Evacuate the area if exposed.
6. Use only cylinders rated DOT4BA/4BW 400.
7. Never fill cylinders over 80% of total capacity.
8. Store cylinders in a cool area, out of direct sunlight.
9. Never heat cylinders above 125°F.
10. Never trap liquid R-410A in manifold sets, gauge lines or cylinders. R-410A expands significantly at warmer temperatures. Once a cylinder or line is full of liquid, any further rise in temperature will cause it to burst.

### Important Installer Note

For improved start-up performance, wash the indoor coil with a dishwashing detergent.

### R410-A Refrigerant Charge

This unit was charged at the factory with the quantity of refrigerant listed on the serial plate. AHRI capacity and efficiency ratings were determined by testing with this refrigerant charge quantity.

Table 10 shows nominal pressures for the units. Since many installation specific situations can affect the pressure readings, this information should only be used by certified technicians as a guide for evaluating proper system performance. They shall not be used to adjust charge. If charge is in doubt, reclaim, evacuate and recharge the unit to the serial plate charge.

**TABLE 10**  
**Cooling Pressures**

Full Load Cooling			Air Temperature Entering Outdoor Coil °F										
Model	Return Air Temp (DB/WB)	Pressure	75	80	85	90	95	100	105	110	115	120	125
HR58	75/62	Low Side	129	130	131	132	133	134	136	137	137	139	140
		High Side	318	340	365	389	414	440	467	495	527	553	584
	80/67	Low Side	138	139	140	141	142	143	145	146	147	149	150
		High Side	326	349	374	399	425	451	479	508	537	567	599
	85/72	Low Side	143	144	145	146	147	148	150	151	152	154	155
		High Side	337	361	387	413	440	467	496	526	556	587	620

Part Load Cooling			Air Temperature Entering Outdoor Coil °F										
Model	Return Air Temp (DB/WB)	Pressure	75	80	85	90	95	100	105	110	115	120	125
HR58	75/62	Low Side	135	136	136	137	137	138	138	140	141	142	143
		High Side	283	304	327	350	375	402	428	456	486	416	547
	80/67	Low Side	144	145	145	146	147	148	148	150	151	152	153
		High Side	290	312	335	359	385	412	439	468	498	529	561
	85/72	Low Side	149	150	150	151	152	153	154	155	156	157	158
		High Side	300	323	347	372	398	426	454	484	515	548	581

Low side pressure ± 4 PSIG  
High side pressure ± 10 PSIG

Tables are based upon rated CFM (airflow) across the evaporator coil. If there is any doubt as to correct operating charge being in the system, the charge should be removed and system evacuated and recharged to serial plate charge weight.

**NOTE:** Pressure table based on high speed condenser fan operation. If condensing pressures appear elevated check condenser fan wiring. See "Condenser Fan Operation".

### Pressure Service Ports

High and low pressure service ports are installed on all units so that the system operating pressures can be observed. Pressures are shown in Table 9.

This unit employs high-flow Coremax valves instead of the typical Schrader type valves.

**WARNING! Do NOT use a Schrader valve core removal tool with these valves. Use of such a tool could result in eye injuries or refrigerant burns!**

To change a Coremax valve without first removing the refrigerant, a special tool is required which can be obtained at [www.fastestinc.com/en/SCCA07H](http://www.fastestinc.com/en/SCCA07H). See the replacement parts manual for replacement core part numbers.

# MAINTENANCE

---

## Standard Maintenance Procedures

### **WARNING**

**Electrical shock hazard.**

**Disconnect all power supplies before servicing.**

**Failure to do so could result in electric shock or death.**

### **CAUTION**

**Cut hazard.**

**Wear gloves to avoid contact with sharp edges.**

**Failure to do so could result in personal injury.**

1. Disable system from LV1000 controller (see LV1000 Service Instructions 2100-673).
2. Turn off AC breakers at wall-mount units.
3. Check inlet sides of condenser and evaporator coils for obstructions/debris—clean if necessary using a quality manufactured coil cleaning product specific for the evaporator or condenser coil.
  - Condenser coil: Remove the upper side panels from the condenser section. This will give clear access to the inlet side of the coil for cleaning. Follow the coil cleaner manufacturer's directions for necessary safety gear and precautions, as well as for application and use. More than one application may be necessary. Rinse thoroughly.
  - Evaporator coil: Open filter access panels and remove filters. Apply specific evaporator cleaner directly to the inlet side of coil, being very careful not to overspray into insulation or surrounding panels and wiring. Residual cleaner and dissolved debris should drip into the drain pan and leave the unit through the condensate hose. More than one application may be necessary. Rinse thoroughly.
4. Manually spin fan and blower motors to ensure they turn freely. All motors are permanently lubricated, so no oil is necessary.
5. Inspect free cooling damper actuator and linkage.
6. Install new air filter; check for additional filter grilles internal to the structure.
7. Inspect the control panel of the system.
  - Look for insect or rodent activity and remove any nesting materials.
  - Manually push contactor closed, observe for movement—contactor points should have minimal discoloration, no spalling or other signs of arcing. Replace if doubtful.
  - Check field and factory wiring for tightness and look for signs of overheating (discoloration of terminals or wire insulation).
8. Ensure that supply and return registers are not obstructed, and more importantly, are not recycling the air to one another. Adjust supply louvers if necessary to direct discharge air away from any direct route to the return grille.
9. Re-assemble wall-mount unit, turn breakers back on.
10. Enable system to LV1000 controller (see LV1000 Service Instructions 2100-673).
11. Repeat steps for additional wall-mount units.

## **Bard Guard Anti-Theft System Option**

For situations that require an individual unit to be disconnected from the Bard Guard security system for an extended period of service time (longer than the maximum 250 minutes disarm time), place a jumper across the appropriate terminals on the BG1000 terminal block to temporarily remove the unit from the security system. **Be sure to remove the jumper from the terminals after service has been completed.**

See the BG1000 Installation Instructions 2100-672 for information on operating the BG1000 controller.