

MANUAL 2100-036B

INSTALLATION INSTRUCTIONS



WALL MOUNTED PACKAGE AIR CONDITIONERS

MODELS

20WA1

24WA2

BAR D MANUFACTURING COMPANY
P. O. Box 607 Bryan, Ohio 43506
(419) 636-1194

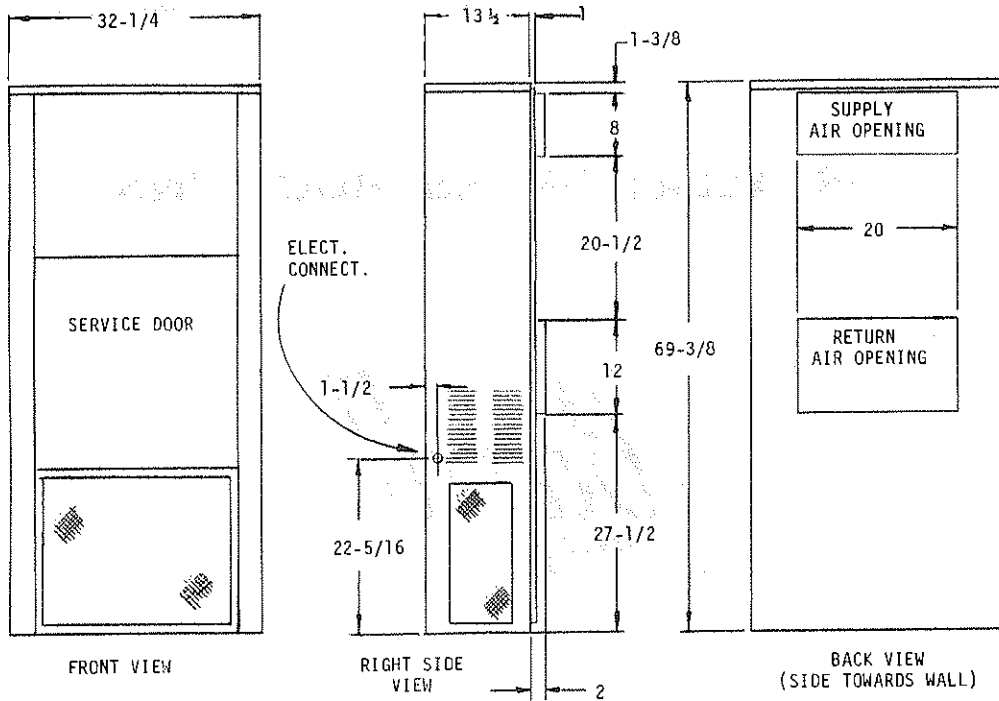

UNIT VOLTAGE RANGE
 230/208-1 240/208-1 480/208-1

ELECTRICAL INFORMATION								WIRING INFORMATION**			
MODEL	Rated Volts & Ph	Operating Voltage Range	Heater* KW	Max Unit Amps	No. Field Power Circuits	Internal Fuses Ckt. A/B	Required Overcurrent Protection	Min. Ckt. Ampacity Ckt. A/B	Field Power Wiring Ckt. A/B	Ground Wire Size Ckt. A/B	Wiring Diagram Number
20WA1	230/208-1	197-253	0	12.8	1		25	16	12	12	4007-110C
			4	17.9	1		25	23	10	10	-120C
			5	22	1		30	28	10	10	-120C
			8	34.5	1		45	43	6	10	-130C
			10	42.8	1		60	54	6	10	-130C
24WA2	230/208-1	197-253	0	16.3	1		30	20	12	12	4007-110C
			4	17.9	1		30	23	10	10	-120C
			5	22	1		30	28	10	10	-120C
			8	34.5	1		45	43	6	10	-130C
			10	42.8	1		60	54	6	10	-130C

*Electric heaters are nominal Kw @ 240V or 480V.
 **Based on 60°C copper wire. Other wiring materials must be rated for marked "minimum circuit ampacity" or greater. Not all models approved for aluminum wire.

⚠ Time delay fuses or "HACR Type" circuit breakers must be used for 60 and smaller sizes. Standard fuses or circuit breakers are suitable for 70 and larger.

APPLICATION AND INSTALLATION INSTRUCTIONS
FOR WA PACKAGE AIR CONDITIONERS

IMPORTANT

The equipment covered in this manual is to be installed by trained, experienced service and installation technicians. Any heat pump is more critical of proper operating, charge and an adequate duct system than a straight air conditioning unit. All ductwork, supply and return, must be properly sized for the design air flow requirement of the equipment. NESCA is an excellent guide to proper sizing. All duct work or portions thereof not in the conditioned space should be properly insulated in order to both conserve energy and prevent condensation or moisture damage.

SHIPPING DAMAGE

Upon receipt of equipment, the carton should be checked for external signs of shipping damage. If damage is found, the receiving party must contact the last carrier immediately, preferably in writing, requesting inspection by the carrier's agent.

GENERAL

The refrigerant system is completely assembled and charged. All internal wiring is complete.

The unit is designed for use with or without duct work. Flanges are provided for attaching the supply and return ducts.

These instructions explain the recommended method to install the air cooled self-contained unit and the electrical wiring connections to the unit.

These instructions and any instructions packaged with any separate equipment required to make up the entire air conditioning system should be carefully read before beginning the installation. Note particularly "Starting Procedure" and any tags and/or labels attached to the equipment.

While these instructions are intended as a general recommended guide, they do not supersede any national and/or local codes in any way. Authorities having jurisdiction should be consulted before the installation is made.

INSTALLATION

Size of unit for a proposed installation should be based on heat loss calculation made according to methods of National Warm Air Heating and Air Conditioning Association. The air duct should be installed in accordance with the Standards of the National Fire Protection Association for the Installation of Air Conditioning and Ventilating Systems of Other Than Residence Type, NFPA No. 90A, and Residence Type Warm Air Heating and Air Conditioning Systems, NFPA No. 90B. Where local regulations are at a variance with instructions, installer should adhere to local codes.

DUCTWORK

Design the ductwork according to methods given by the National Warm Air Heating and Air Conditioning Association. When duct runs through unheated spaces, it should be insulated with a minimum of two inches of insulation. Use insulation with a vapor barrier on the outside of the insulation. Flexible joints should be used to connect the ductwork to the equipment in order to keep the noise transmission to a minimum.

A one inch clearance to combustible material for the first three feet of duct attached to the outlet air frame is required. See page 6 for further details.

FILTER

A 1" throwaway filter is supplied with each unit. The filter slides into position making it easy to service. This filter can be serviced from the outside by removing the service door.

FRESH AIR INTAKE

All units are built with a fresh air inlet hole punched in the service panel. The fresh air damper assembly is shipped with each unit, and must be attached at the installation site. See Figure 1 for typical installation procedure.

The fresh air damper assembly is standard equipment with the unit because of the variety of state or local codes requiring fresh air capability.

All capacity, efficiency and cost of operation information as required for Department of Energy "Energy-guide" Fact Sheets is based upon the fresh air blank-off plate in place and is recommended for maximum energy efficiency.

The blank-off plate is available upon request from the factory and is installed in place of the fresh air damper shipped with each unit.

WALL MOUNTING

1. Two holes, the size of the supply and return air openings must be cut through the wall as shown in Figure 2.
2. On wood-frame walls, the wall construction must be strong and rigid enough to carry the weight of the unit without transmitting any unit vibration.
3. Concrete block walls must be thoroughly inspected to insure that they are capable of carrying the weight of the installing unit.
4. Ducts through the walls must be insulated and all joints taped or sealed to prevent air or moisture entering the wall cavity.
5. Some installations may not require any return air duct. It is recommended that on this type of installation that a filter grille be located in the wall. Filters must be of sufficient size to allow a maximum velocity of 400 FPM.

NOTE: If no return air duct is used, applicable installation codes may limit this cabinet to installation only in a single story structure.

WIRING - MAIN POWER

Refer to the unit rating plate for wire sizing information and maximum fuse or "HACR Type" circuit breaker size. Each outdoor unit is marked with a "Minimum Circuit Ampacity." This means that the field wiring used must be sized to carry that amount of current. Depending on the installed Kw of electric heat, there may be two field power circuits required. If this is the case, the unit serial plate will so indicate. Some models are suitable only for connection with copper wire, while others can be wired with either copper or aluminum wire. Each unit and/or wiring diagram will be marked "Use Copper Conductors Only" or "Use Copper or Aluminum Conductors." These instructions MUST BE adhered to. Refer to the National Electrical Code for complete current carrying capacity data on the various insulation grades of wiring material.

The electrical data lists fuse and wire sizes (60°F copper) for all models, including the most commonly used heater sizes. Also shown are the number of field power circuits required for the various models with heaters.

The unit rating plate lists a "Maximum Time Delay Fuse" or "HACR Type" circuit breaker that is to be used with the equipment. The correct size must be used for proper circuit protection and also to assure that there will be no nuisance tripping due to the momentary high starting current of the compressor motor.

IMPORTANT INSTALLER NOTES:

1. For improved start-up performance wash the indoor coil with a dishwasher detergent.

PRESSURE SERVICE PORTS

High and low pressure service ports are installed on all units so that the system operating pressures can be observed. Pressure curves can be found later in the manual covering all models on both cooling and heating cycles. It is imperative to match the correct pressure curve to the unit by model number.

CRANKCASE HEATERS

All units are provided with some form of compressor crankcase heat. Some single phase units utilize the compressor motor start winding in series with a portion of the run capacitor to generate heat within the compressor shell to prevent liquid refrigerant migration.

Some three phase units utilize a wraparound type of crankcase heater that warms the compressor oil from the outside.

Some single and three phase models have an insertion well-type heater located in the lower section of the compressor housing. This is a self-regulating type heater that draws only enough power to maintain the compressor at a safe temperature.

Some form of crankcase heat is essential to prevent liquid refrigerant from migrating to the compressor, causing oil pump out on compressor start-up and possible valve failure due to compressing a liquid.

Refer to unit wiring diagram to find exact type of crankcase heater used.

The following decal is affixed to all outdoor units detailing start-up procedure. This is very important. Please read carefully.

<p style="text-align: center;"><u>IMPORTANT</u></p> <p>THESE PROCEDURES MUST BE FOLLOWED AT INITIAL START-UP AND AT ANY TIME POWER HAS BEEN REMOVED FOR 12 HOURS OR LONGER.</p> <p>TO PREVENT COMPRESSOR DAMAGE WHICH MAY RESULT FROM THE PRESENCE OF LIQUID REFRIGERANT IN THE COMPRESSOR CRANKCASE</p> <ol style="list-style-type: none">1. MAKE CERTAIN THE ROOM THERMOSTAT IS IN THE "OFF" POSITION (THE COMPRESSOR IS NOT TO OPERATE).2. APPLY POWER BY CLOSING THE SYSTEM DISCONNECT SWITCH THIS ENERGIZES THE COMPRESSOR HEATER WHICH EVAPORATES THE LIQUID REFRIGERANT IN THE CRANKCASE.3. ALLOW 4 HOURS OR 80 MINUTES PER POUND OF REFRIGERANT IN THE SYSTEM AS NOTED ON THE UNIT RATING PLATE, WHICHEVER IS GREATER.4. AFTER PROPERLY ELAPSED TIME THE THERMOSTAT MAY BE SET TO OPERATE THE COMPRESSOR.5. EXCEPT AS REQUIRED FOR SAFETY WHILE SERVICING - <u>DO NOT OPEN SYSTEM DISCONNECT SWITCH.</u> <p style="text-align: right;">7961-061</p>
--

FAN BLADE SETTING DIMENSIONS

Shown in the drawing below are the correct fan blade setting dimensions for proper air delivery across the outdoor coil.

Any service work requiring removal or adjustment in the fan and/or motor area will require that the dimensions below be checked and blade adjusted in or out on the motor shaft accordingly.

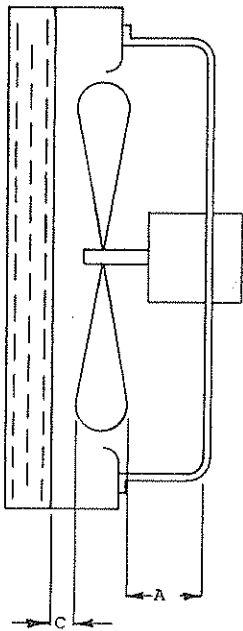

MODEL	DIM. A	DIM. C
20WA1	3/4"	1-1/2"
24WA2	3/4"	1-1/4"

FAN BLADE REMOVAL

To facilitate removal of the fan blade for replacement or inspection, it is easiest to remove the air inlet grille on the right side (located under the electrical connections to the cabinet), and then to remove the three screws securing the fan enclosure to the coil and the three screws securing the fan enclosure to the unit base. The three screws at the opposite end that secure the fan enclosure to the coil remain in place. The fan enclosure can then be swung back towards the rear of the unit, gaining enough clearance for the fan blade to be extruded from the unit.

Reverse the above procedure to put the unit back into an operating condition. Be sure to adjust the fan blade to the correct setting as shown under "Fan Blade Setting Dimensions" before locking down the set screws on to the flats of the motor shaft.

REFRIGERANT CHARGE

The correct system R-22 charge is shown on the unit rating plate. Optimum unit performance will occur with a refrigerant charge resulting in a suction line temperature (6" from compressor) as shown in the following table:

Model	Rated Airflow	95°F OD Temp.	82°F OD Temp.
20WA1	710	56-58	63-65
24WA2	815	51-53	56-58

The above suction line temperatures are based upon 80°F dry bulb/67°F wet bulb (50% R.H.) temperature and rated airflow across the evaporator during cooling cycle.

INDOOR BLOWER PERFORMANCE CFM — DRY COIL WITH FILTER	
E.S.P. INCHES H ₂ O	MODEL 20WA1, 24WA2
.0	950
.1	890
.2	815
.3	740
.4	655
.5	575
.6	--

RATED CFM AND E.S.P. (WET COIL—COOLING)			
MODEL	RATED CFM	RATED E.S.P.	RECOMMENDED AIRFLOW RANGE
20WA1	710	.29	640 - 800
24WA2	815	.10	725 - 900

UNIT MODELS

20WA1
24WA2
18WH2
24WH2

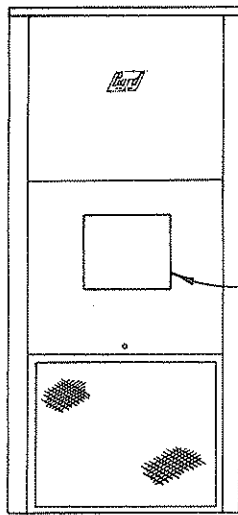

Model FAD10
Fresh Air Cover
With Adjustable
Damper

UNIT MODELS

30WA2
36WA4
30WH1
36WH2
42WA
49WA
48WH2

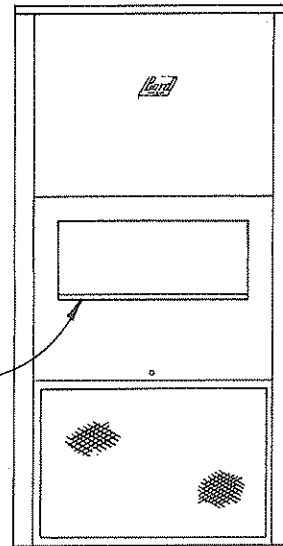

MODEL FAD25
Fresh Air Cover
With Adjustable
Damper

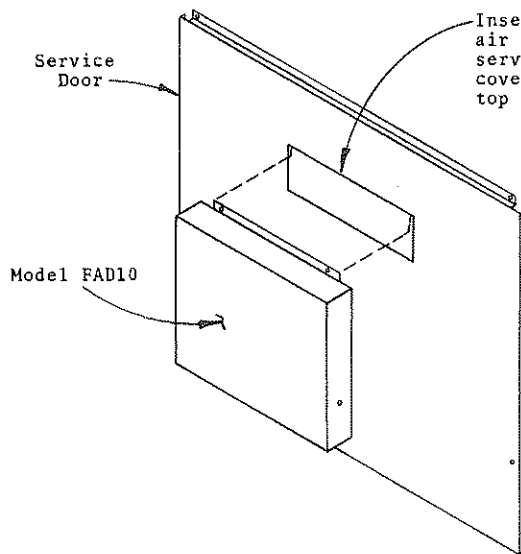

Insert top flange of fresh
air cover into opening in
service door and push top of
cover assembly all the way to
top of opening.

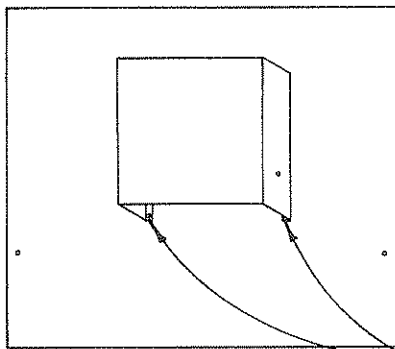
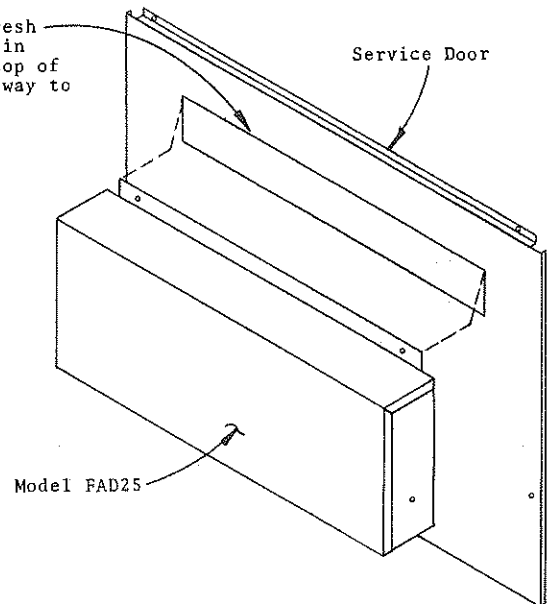

Secure bottom of
Fresh Air Cover Assembly
with two screws.

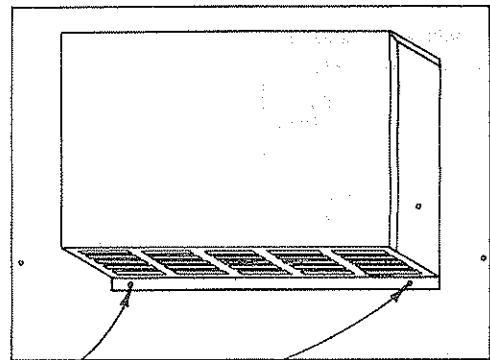
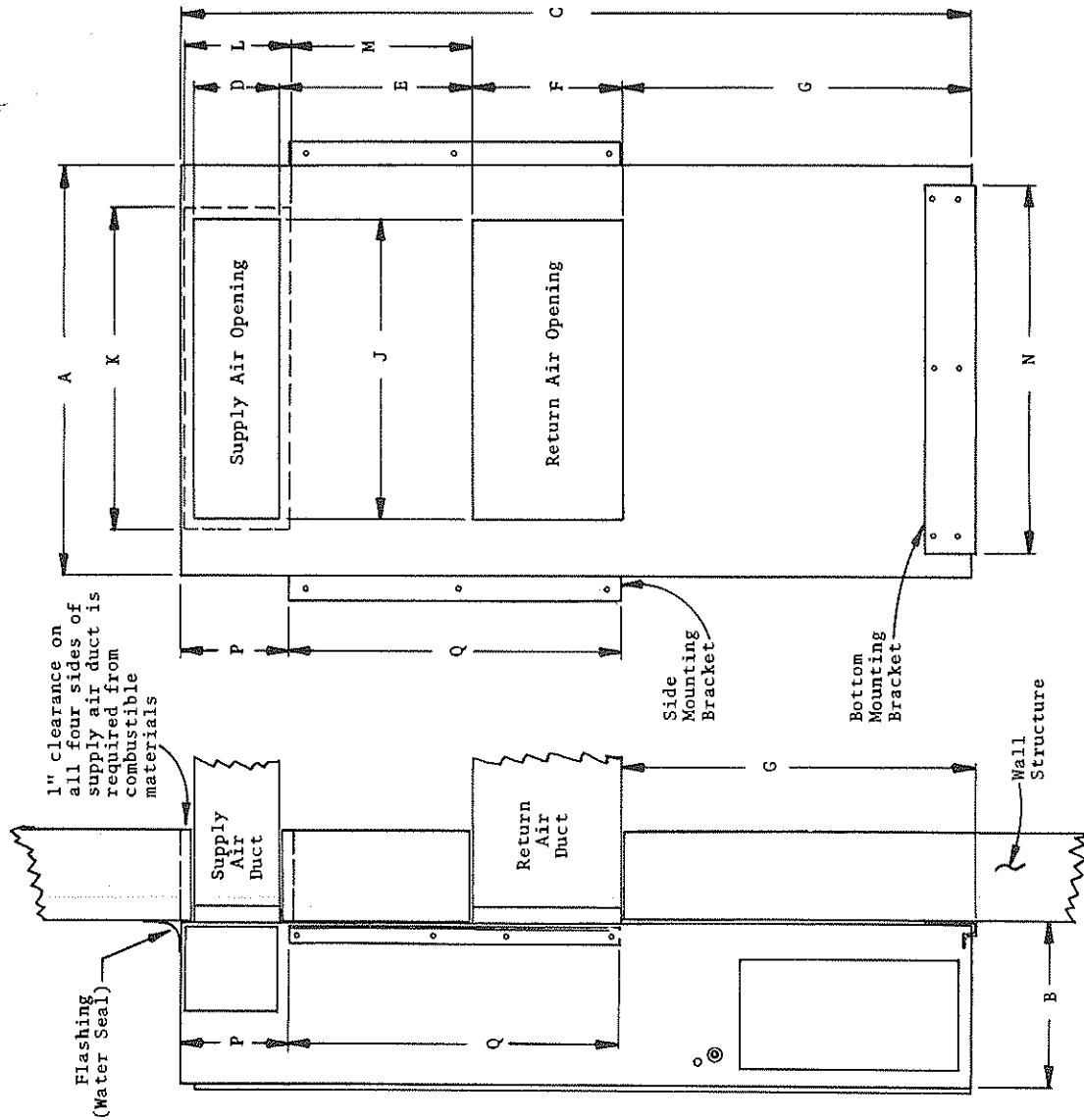

FIGURE 1

SIDE VIEW

WALL VIEW



MOUNTING INSTRUCTIONS

1. These units are secured by wall mounting brackets which secure the unit to the outside wall surface at both sides and at the bottom.
2. The unit itself is suitable for "0" inch clearance, but the supply air duct flange and the first few feet of supply air duct require 1 inch clearance to combustible material. If combustible wall, use K and L dimensions for sizing, if non-combustible, use D and J.
3. After the wall opening positions have been selected, lay out the position for the bottom and side brackets. Fasten the brackets securely to the wall (type of fasteners will depend on wall construction).
4. Be sure to observe the P dimension when attaching the side brackets. This will assure that no screws are driven into the unit sides damaging any internal parts. One-half inch sheet metal screws are recommended.
5. For additional mounting rigidity, the return air and supply air (depending upon wall construction) frames or collars can be drilled and screwed or welded to the structural wall itself. Be sure to observe required clearance if combustible wall.

MODEL	A	B	C	D	E	F	G	J	K	L	M	N	P	Q
20WAL, 24WA2	32-1/4	13-1/2	69-3/8	8	20-1/2	12	27-1/2	20	22	10	19-1/2	24	10	31
18WHZ, 24WHZ														
30WA2, 36WA4	38-1/4	15-1/4	74	8	18	14	32-5/8	28	30	10	17	34	10	31
30WH1, 36WH2														
42WA, 49WA	42	22	84	10	30	16	26-5/8	30	32	12	29	34	10	42
48WHZ														

FIGURE 2

BARD MANUFACTURING COMPANY

24WA2

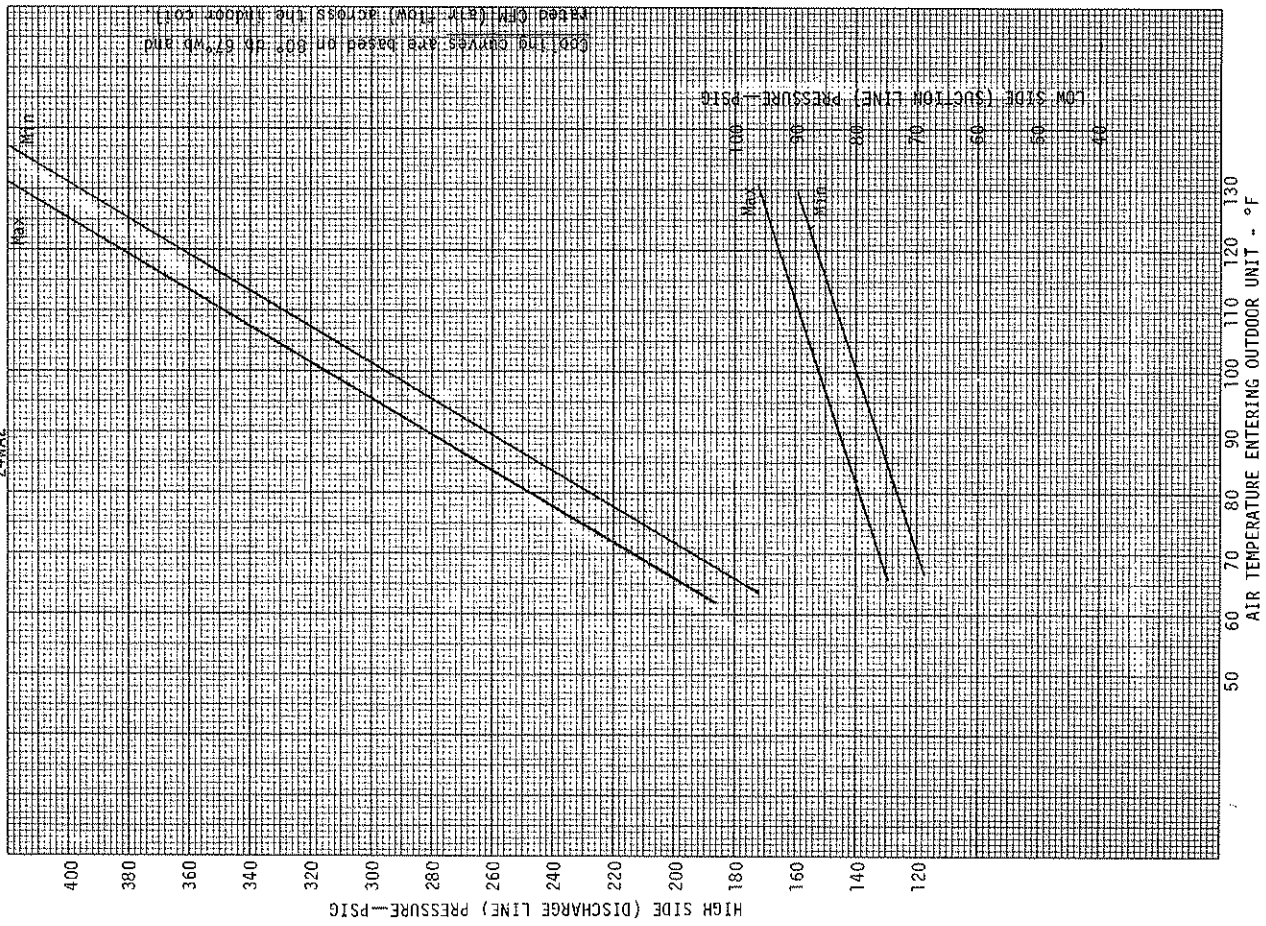

BARD MANUFACTURING COMPANY

20WA1

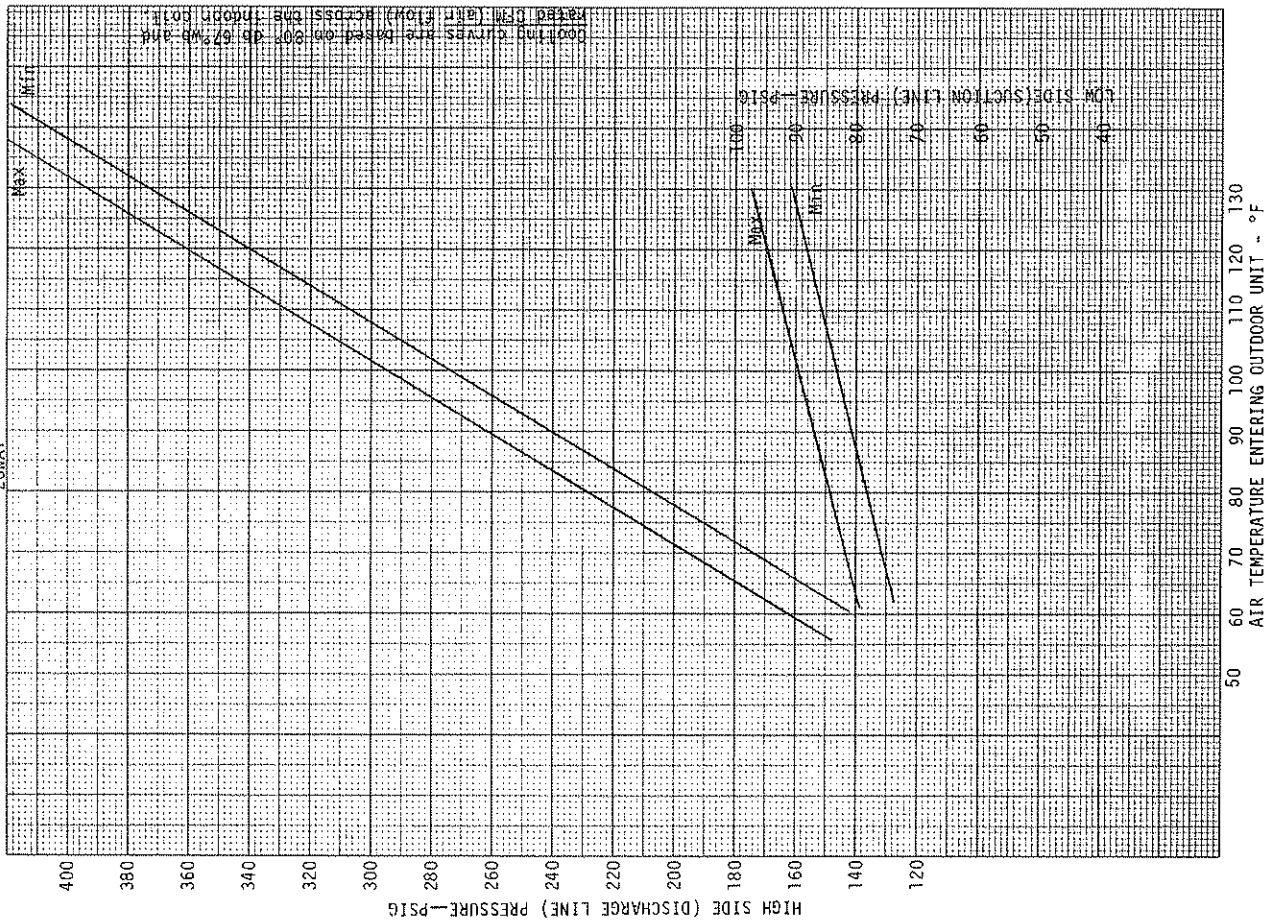

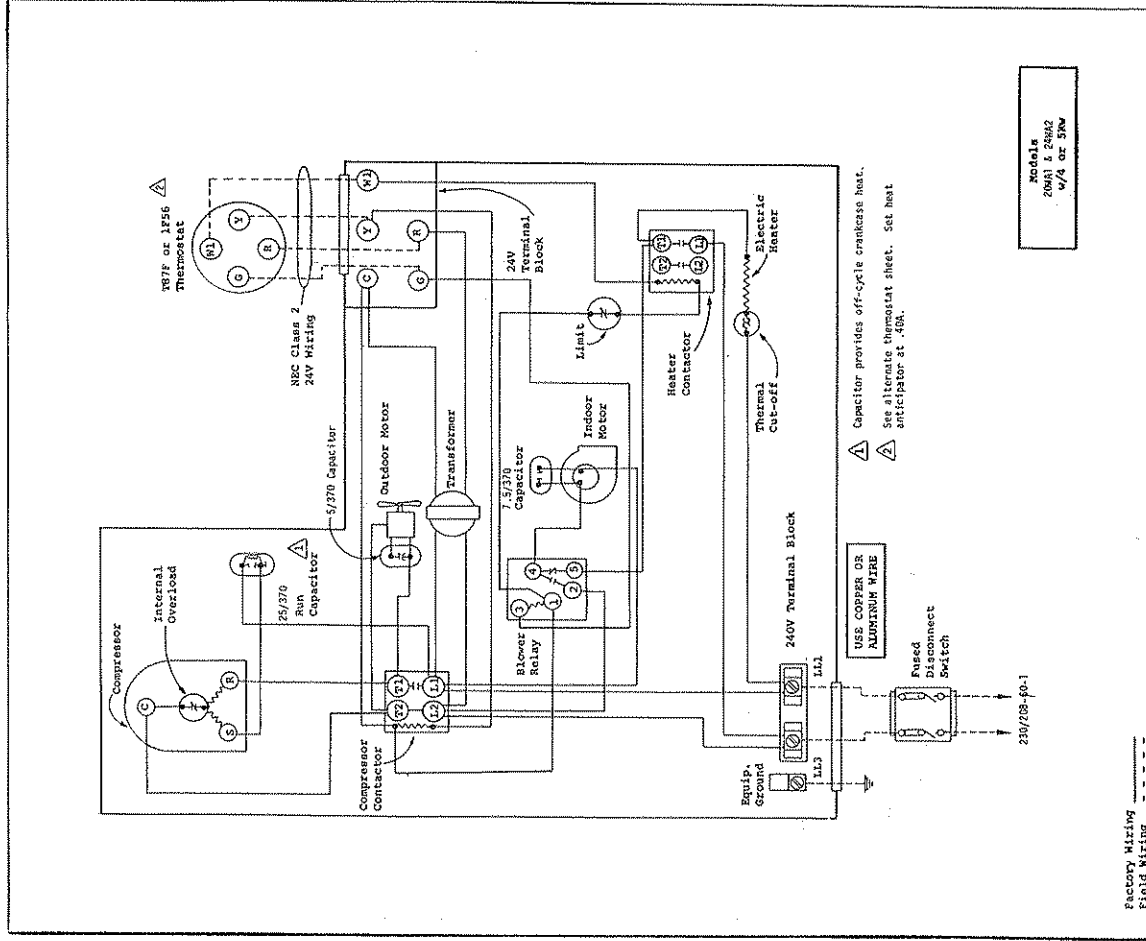
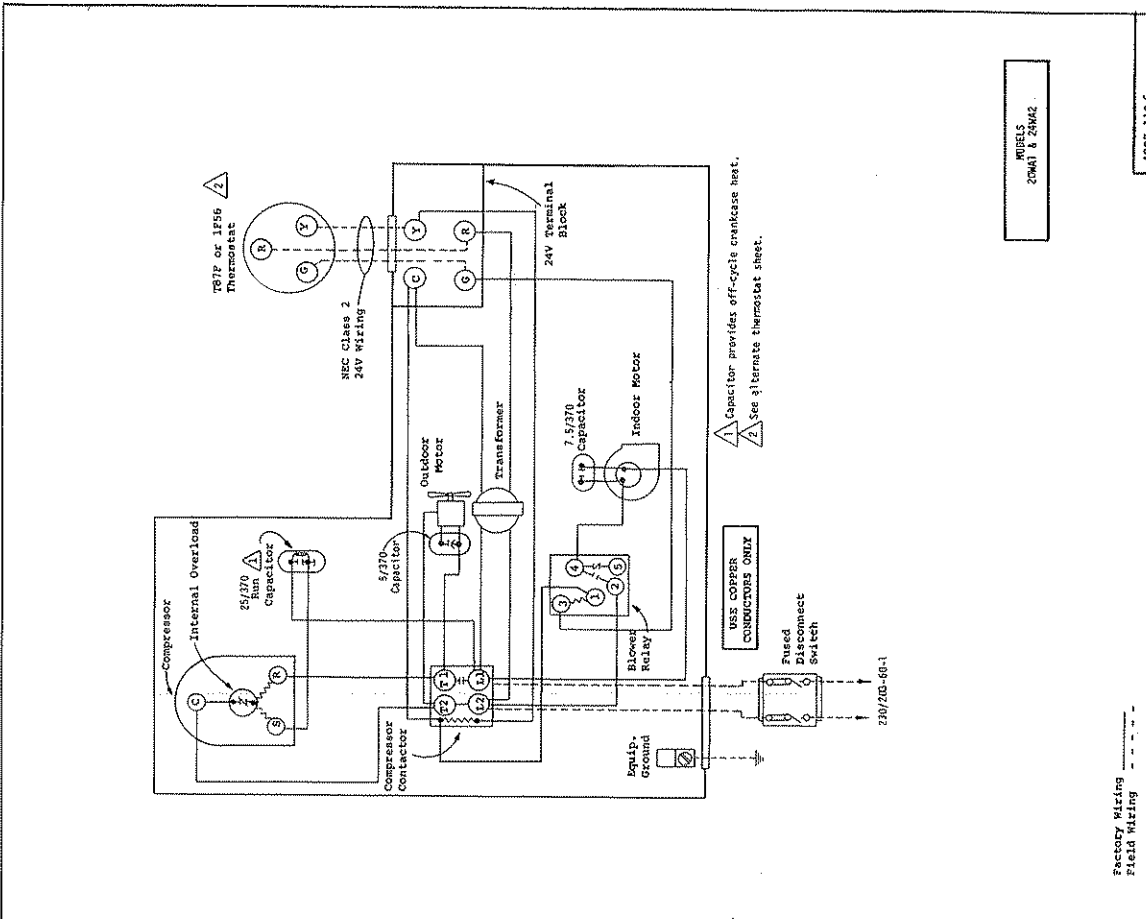

PARTS LIST
SINGLE PACKAGE AIR CONDITIONERS

Effective 1/1/80
Supersedes 1/1/79

PART NO.	DESCRIPTION	20WA1	24WA2
5152-030	Blower Housing 9-7	X	X
5152-028	Blower Wheel 9-7	X	X
5152-029	Blower Wheel 9-7	X	X
8552-027	Capacitor 25/370V	X	X
8552-002	Capacitor 5/370V	X	X
5811-021	Capillary Tube - Cool	X	X
5811-020	Capillary Tube - Cool	X	X
8000-061	Compressor RES3-0175-PFV-270	X	X
8000-062	Compressor AB224FT-014-A4	X	X
5051-017	Condenser Coil	X	X
5051-025	Condenser Coil	X	X
8401-007	Contact - Heater 25A	X	X
8401-006	Contact - Heater 2P18	X	X
5060-024	Evaporator Coil	X	X
5151-024	Fan Blade A-1831-5	X	X
7004-006	Filter 14x25	X	X
8604-041	Heat Strip 4Kw	X	X
8604-042	Heat Strip 5Kw	X	X
8604-043	Heat Strip 8Kw	X	X
8604-044	Heat Strip 10Kw	X	X
8402-029	Limit Switch 160°	X	X
8102-008	Motor - Blower 1/6 hp	X	X
8103-009	Motor - Fan 1/5 hp	X	X
8552-004	Capacitor 7.5/370V	X	X
8200-023	Motor Mount - Fan	X	X
5210-002	Strainer	X	X
8201-009	Relay - Blower	X	X
8607-006	Terminal Board 24V	X	X
8607-001	Terminal Block 230V	X	X
8402-03D	Thermal Cut-off	X	X
8407-007	Transformer 40VA	X	X

Minimum Net Billing \$15.00. Supersedes all previous lists.
Subject to change without notice. F.O.B. Bryan, Ohio.

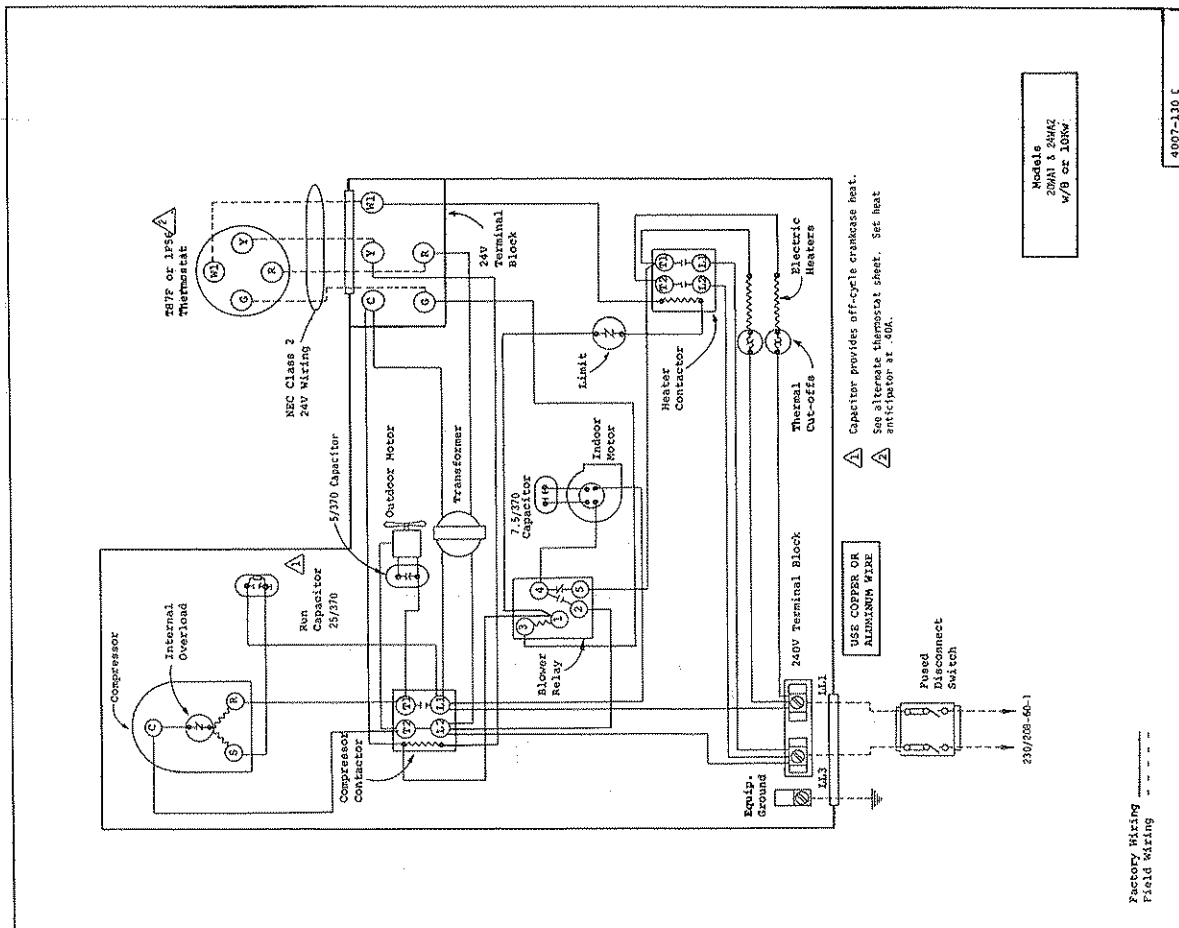

Factory Wiring
Field Wiring