

INSTALLATION INSTRUCTIONS



WALL MOUNTED PACKAGE AIR CONDITIONERS

MODELS
30WA2
36WA4

BAR D MANUFACTURING COMPANY
P. O. Box 607 Bryan, Ohio 43506
(419) 636-1194

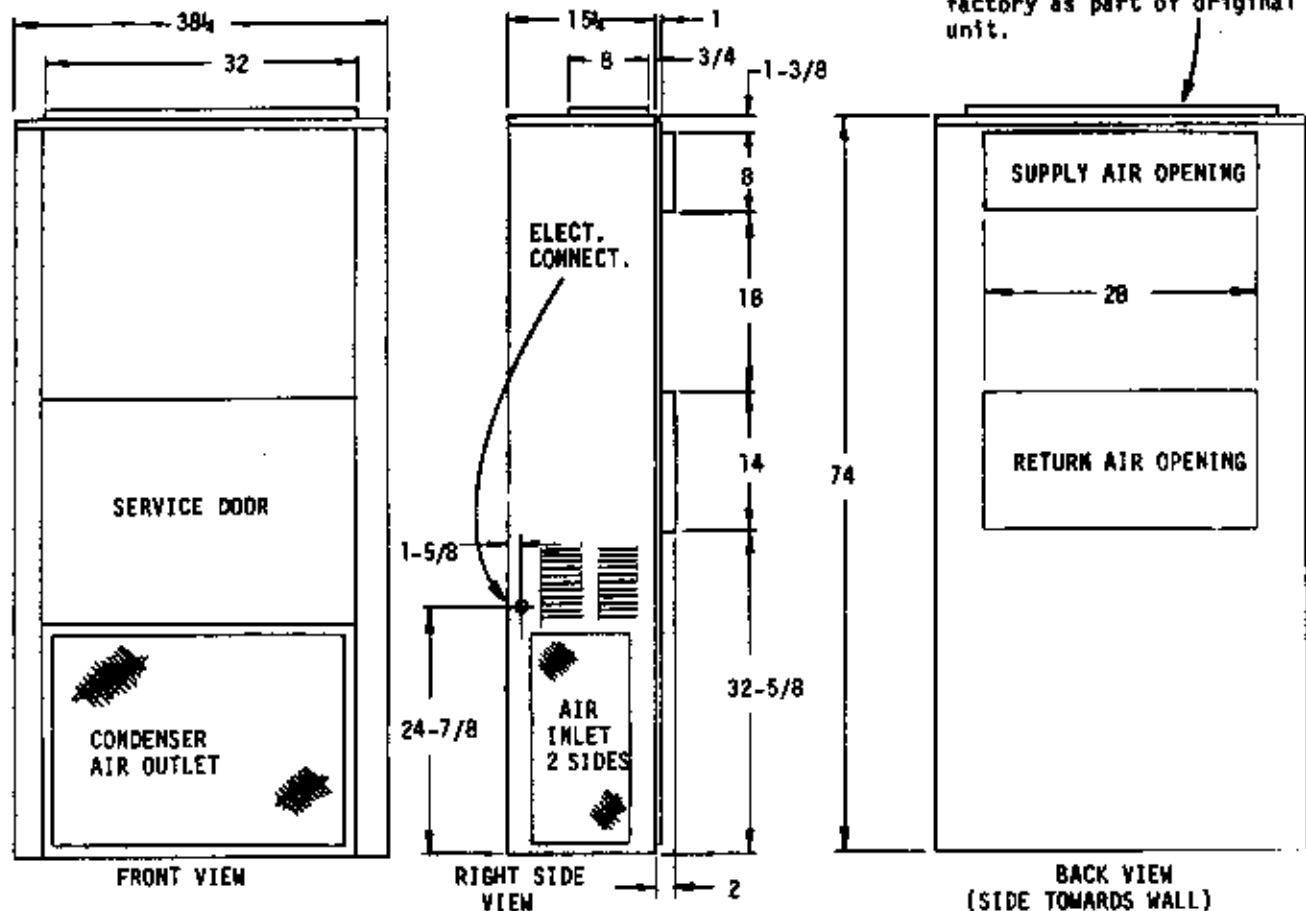

| ELECTRICAL INFORMATION | | | | | | | | WIRING INFORMATION** | | | |
|------------------------|------------------|-------------------------|-------------|---------------|--------------------------|----------------|------------------|----------------------|--------------------|------------------|---|
| Model | Rated Volts & Ph | Operating Voltage Range | Heater** Kw | Max Unit Amps | No. Field Power Circuits | Internal Fuses | Req'd Ext. Fuses | Min. Ckt. Ampacity | Field Power Wiring | Ground Wire Size | Wiring Diagram Number |
| 30WA2 | 230/208-1 | 197-253 | 0 | 21.3 | 1 | 60/30 | 40 | 25 | 10 | 10 | 4008-110D -120C -130C -140C |
| | | | 5 | 23 | 1 | | 40 | 30 | 10 | | |
| | | | 10 | 43.8 | 1 | | 60 | 56 | 4 | 10 | |
| | | | 15 | 64.7 | 1 | | 90 | 82 | 2 | 8 | |
| 36WA4 | 230/208-1 | 197-253 | 0 | 24.3 | 1 | 60/30 | 45 | 30 | 10 | 10 | 4009-110E -120E -130F -140F |
| | | | 5 | 24.3 | 1 | | 45 | 30 | 10 | 10 | |
| | | | 10 | 43.8 | 1 | | 60 | 56 | 4 | 10 | |
| | | | 15 | 64.7 | 1 | | 90 | 82 | 2 | 8 | |
| 36WA4 | 230/208-3 | 187-253 | 0 | 17.3 | 1 | | 30 | 21 | 10 | 10 | 4009-210C -220E -220E -230E -230E |
| | | | 6 | 17.3 | 1 | | 30 | 21 | 10 | 10 | |
| | | | 9 | 23.9 | 1 | | 35 | 31 | 8 | 10 | |
| | | | 12 | 31.1 | 1 | | 40 | 40 | 8 | 10 | |
| | | | 15 | 38.3 | 1 | | 50 | 50 | 6 | 10 | |
| 36WA4 | 460/3 | 414-506 | 0 | 9.5 | 1 | | 15 | 15 | 14 | 14 | 4009-310B -320C -320C -320C -320C |
| | | | 6 | 9.5 | 1 | | 15 | 15 | 14 | 14 | |
| | | | 9 | 11.9 | 1 | | 15 | 15 | 14 | 14 | |
| | | | 12 | 15.5 | 1 | | 20 | 20 | 12 | 10 | |
| | | | 15 | 19.1 | 1 | | 25 | 24 | 10 | 10 | |

*Electric heaters are nominal Kw @ 240V.

**Based on using 60°C copper wire. Other wiring materials must be rated for marked minimum circuit ampacity or greater. Not all models approved for aluminum wire.

⚠ Time Delay Fuse or Circuit Breaker.

APPLICATION AND INSTALLATION INSTRUCTIONS

GENERAL

Units are shipped completely assembled and internally wired, requiring only duct connections, thermostat wiring and external 220-240 volt AC power supply. The refrigerant system is completely assembled and charged.

These instructions and any instructions packaged with any separate equipment should be carefully read before beginning the installation. Note particularly any tags and/or labels attached to the equipment.

While these instructions are intended as a general recommended guide, they do not supersede any national and/or local codes in any way. Authorities having jurisdiction should be consulted before the installation is made.

SHIPPING DAMAGE

Upon receipt of equipment, the carton should be checked for external signs of shipping damage. If damage is found, the receiving party must contact the last carrier immediately, preferably in writing, requesting inspection by the carrier's agent.

INSTALLATION

Size of unit for a proposed installation should be based on heat loss calculation made according to methods of National Warm Air Heating and Air Conditioning Association. The air duct should be installed in accordance with the Standards of the National Fire Protection Association for the Installation of Air Conditioning and Ventilating Systems of Other Than Residence Type, NFPA No. 90A, and Residence Type Warm Air Heating and Air Conditioning Systems, NFPA No. 90B. Where local regulations are at a variance with instructions, installer should adhere to local codes.

DUCTWORK

Design the ductwork according to methods given by the National Warm Air Heating and Air Conditioning Association. When duct runs through unheated spaces, it should be insulated with a minimum of two inches of insulation. Use insulation with a vapor barrier on the outside of the insulation. Flexible joints should be used to connect the ductwork to the equipment in order to keep the noise transmission to a minimum.

A one inch clearance to combustible material for the first three feet of duct attached to the outlet air frame is required. See page 4 for further details.

FILTER

A 1" throwaway filter is supplied with each unit. The filter slides into position making it easy to service. This filter can be serviced from the outside by removing the service door.

FRESH AIR INTAKE

All units are built with a fresh air inlet hole punched in the service panel. The fresh air damper assembly is shipped with each unit, and must be attached at the installation site. See Fig. 3 on page 6 for typical installation procedure.

The fresh air damper assembly is standard equipment with the unit because of the variety of state or local codes requiring fresh air capability.

All capacity, efficiency and cost of operation information as required for Department of Energy "Energyguide" Fact Sheets is based upon the fresh air blank off plate in place and is recommended for maximum energy efficiency.

The blank off plate is available upon request from the factory and is installed in place of the fresh air damper shipped with each unit.

WALL MOUNTING

1. Two holes, the size of the supply and return air openings must be cut through the wall as shown in Fig. 1 and 2 on page 5.
2. On wood-frame walls, the wall construction must be strong and rigid enough to carry the weight of the unit without transmitting any unit vibration.
3. Concrete block walls must be thoroughly inspected to insure that they are capable of carrying the weight of the installing unit.
4. Ducts through the walls must be insulated and all joints taped or sealed to prevent air or moisture entering the wall cavity.
5. Some installations may not require any return air duct. It is recommended that on this type of installation, a filter grille be located in the wall. Filters must be of sufficient size to allow a maximum velocity of 400 FPM.

WIRING - MAIN POWER

Refer to the unit rating plate for wiring size information and maximum fuse size. Each outdoor unit is marked with a "Minimum Circuit Ampacity." This means that the field wiring used must be sized to carry that amount of current. Depending on the installed Kw of electric heat, there may be two field power circuits required. If this is the case, the unit serial plate will so indicate. Some models are suitable only for connection with copper wire, while others can be wired with either copper or aluminum wire. Each unit and/or wiring diagram will be marked "Use Copper Conductors Only" or "Use Copper or Aluminum Conductors." These instructions MUST BE adhered to. Refer to the National Electrical Code for complete current carrying capacity data on the various insulation grades of wiring material.

The electrical specifications on page 1 lists fuse and wire sizes (60°F copper) for all models, including the most commonly used heater sizes. Also shown are the number of field power circuits required for the various models with heaters.

The unit rating plate lists a "Maximum Time Delay Fuse" that is to be used with the equipment. The correct size fuse must be used for proper circuit protection and also to assure that there will be no nuisance tripping due to the momentary high starting current of the compressor motor.

PRESSURE SERVICE PORTS

High and low pressure service ports are installed on all units so that the system operating pressures can be observed. Pressure curves can be found later in the manual covering all models on both cooling and heating cycles. It is imperative to match the correct pressure curve to the unit by model number.

CONDENSATE DRAIN

A plastic drain hose extends from the drain pan at the top of the unit down to the unit base. There are openings in the unit base for the drain hose to pass through. In the event the drain hose is connected to a drain system of some type, it must be an open or vented type system to assure proper drainage.

FAN BLADE SETTING DIMENSIONS

Shown in the drawing below are the correct fan blade setting dimensions for proper air delivery across the outdoor coil.

Any service work requiring removal or adjustment in the fan and/or motor area will require that the dimensions below be checked and blade adjusted in or out on the motor shaft accordingly.

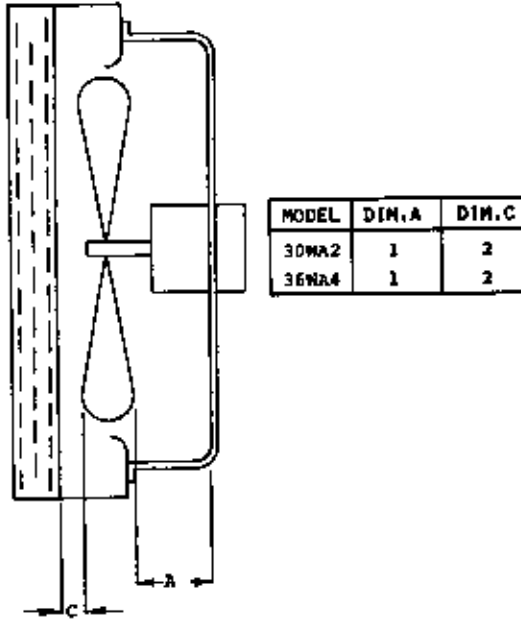

REFRIGERANT CHARGE

The correct system R-22 charge is shown on the unit rating plate. Optimum unit performance will occur with a refrigerant charge resulting in a suction line temperature (6" from compressor) as shown in the following table:

| Model | Rated Airflow | 95°F OD Temp. | 82°F OD Temp. |
|-------|---------------|---------------|---------------|
| 30WA2 | 1140 | 48-50 | 57-59 |
| 36WA4 | 1185 | 46-48 | 51-53 |

The above suction line temperatures are based upon 80°F dry bulb/67°F wet bulb (50% R.H.) temperature and rated airflow across the evaporator during cooling cycle.

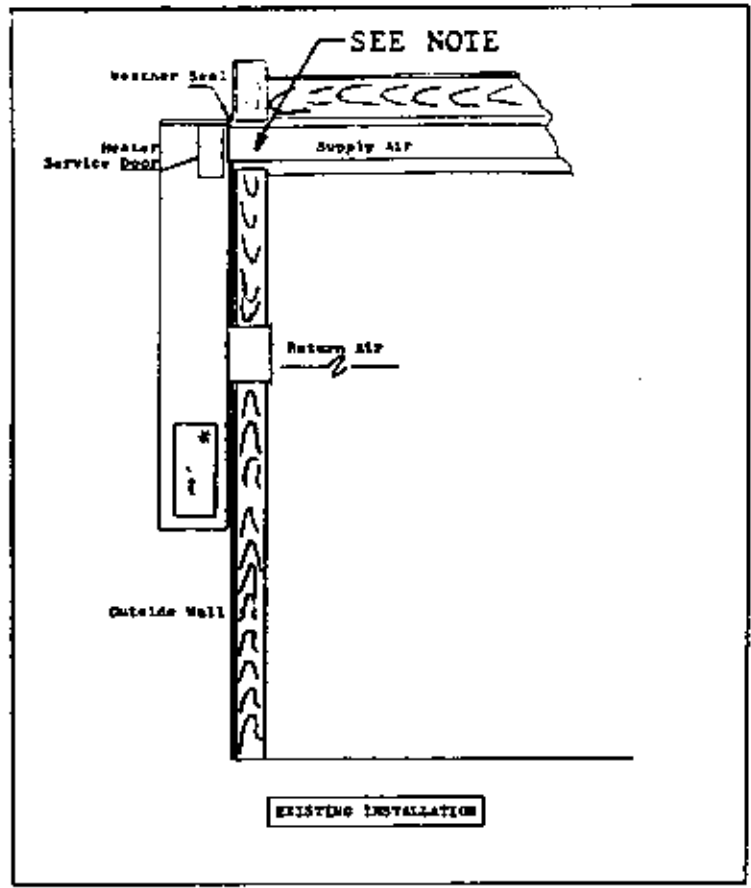
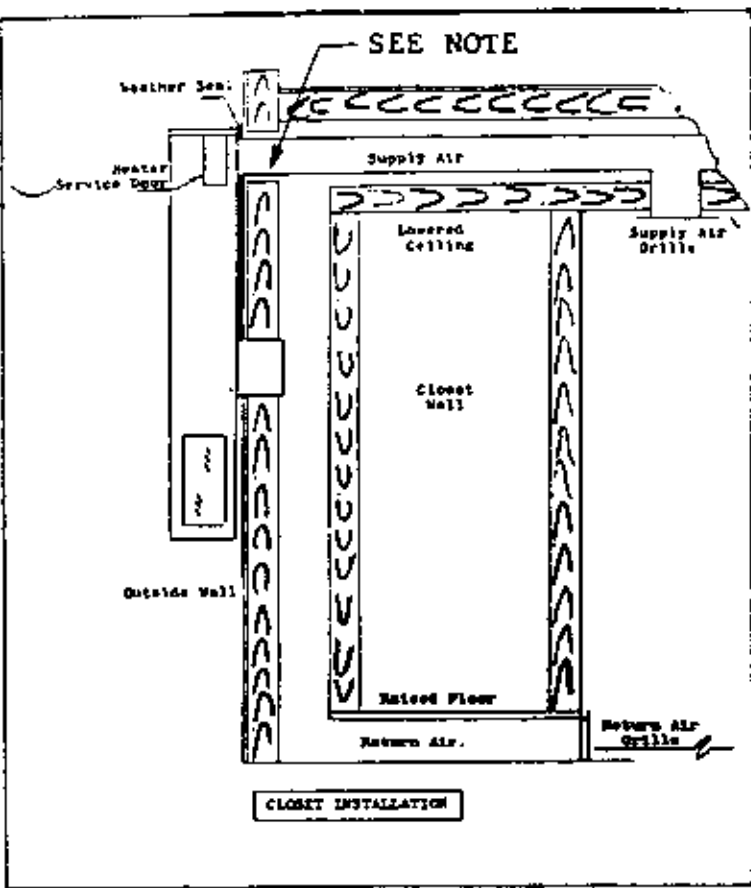

NOTE: 1" clearance to combustable materials required for first 3 feet of supply air duct system.

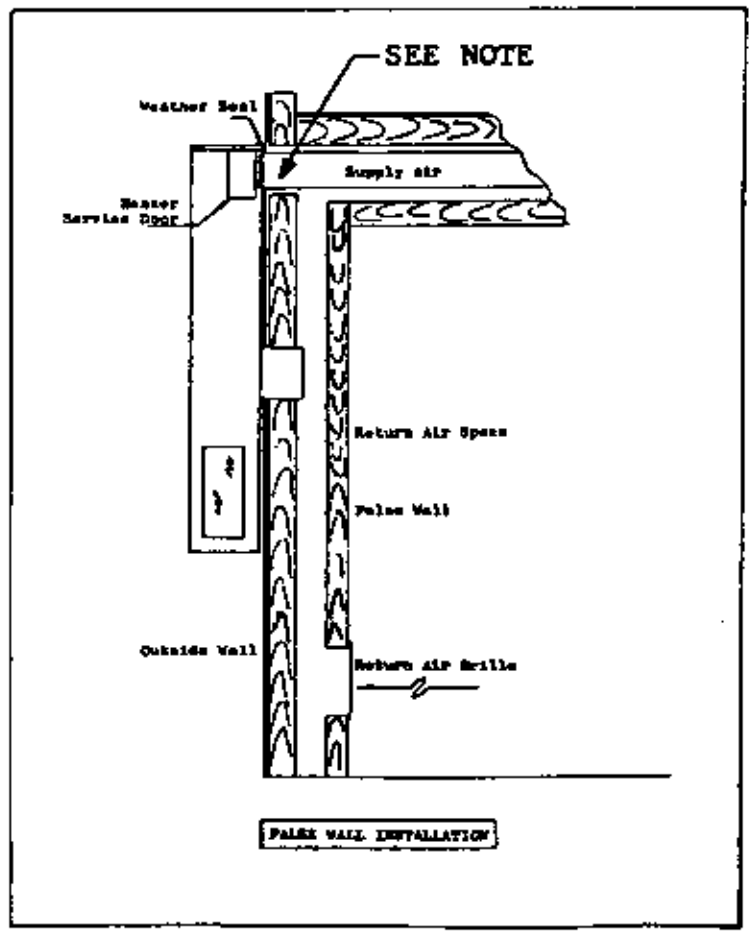
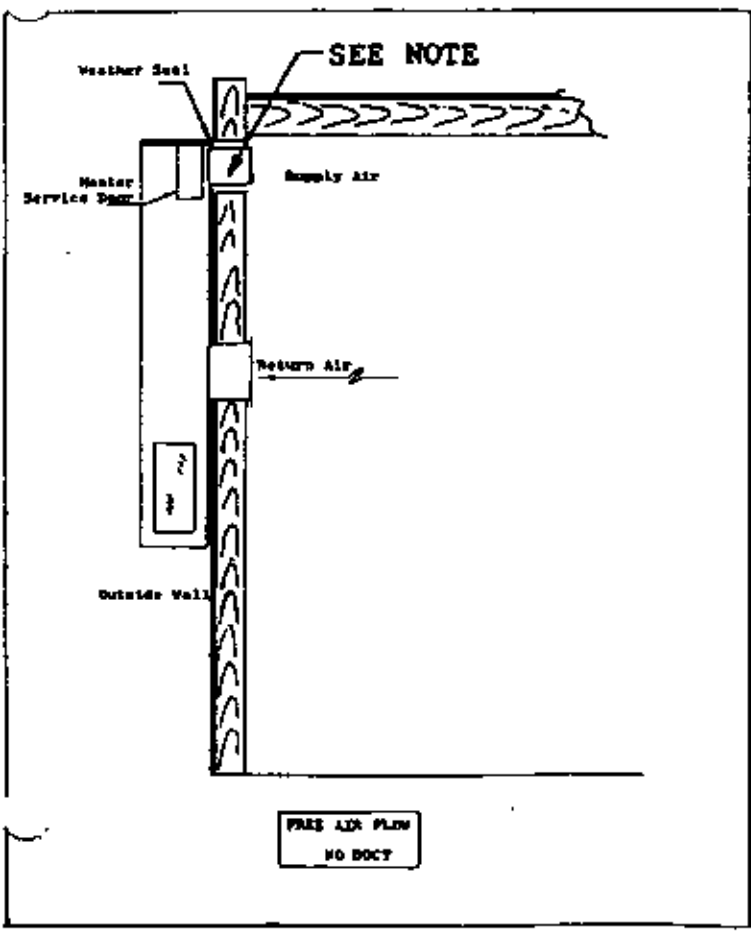

MODELS 30WA2 and 36WA4

MOUNTING ON CONCRETE BLOCK WALL

These units are secured by wall mounting brackets which secure the unit to the outside wall surface at both sides and at the bottom (Fig.).

In a standard 8 x 16 in. block wall, knock out two 26 in. sections of concrete blocks normally the 7th, 8th, and 11th course of blocks above floor level. In both cases this should be one whole block plus 7 in. of the block on each side.

On the wall, lay out approximately the position for the bottom and side brackets. Fasten these brackets to the wall firmly with 3/8 in. lag screws.

The side brackets should be located approximately 15 in. down from the top of the unit and fastened to both sides with metal screws. Before drilling into side of casing, check inside tubing for clearance. After mounting the unit on the wall a metal weather stripping should be installed at the top to insure a water tight application.

INSTALLATION SCHEMATIC

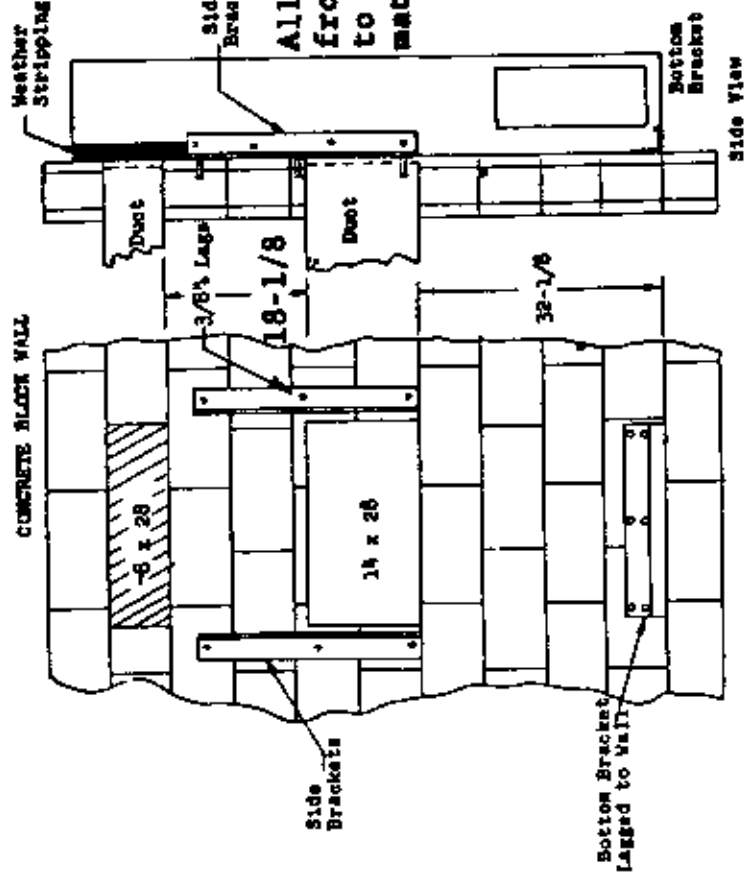

Fig. 1

MODELS 30WA2 and 36WA4

MOUNTING ON WOOD FRAME WALLS

Locate and cut out two openings as shown in (Fig.). Cut away the outside siding to the depth of the sheathing. Install metal stripping at the top and oak or otherwise seal joints between siding and sheathing. Frame in the openings between the wall studs as necessary for the particular wall involved with the plates at the bottom of each wall opening being sufficiently strong to carry the weight of the unit.

Install the two side brackets to the unit (15 in. down from the top). Before drilling into side of casing, check inside tubing for clearance. Mount unit on wall and pull in firmly using three 3/8 in. lag screws through each of the wall mounting brackets.

For additional mounting rigidity, each air opening collar may be screwed to the plate at the bottom of each wall opening. Drill two 1/8 in. holes in the bottom flange of each collar before hanging the unit, then fasten to wall plates with No. 10 by 1-1/2 in. wood screws.

OUTSIDE FRAME WALL SCHEMATIC

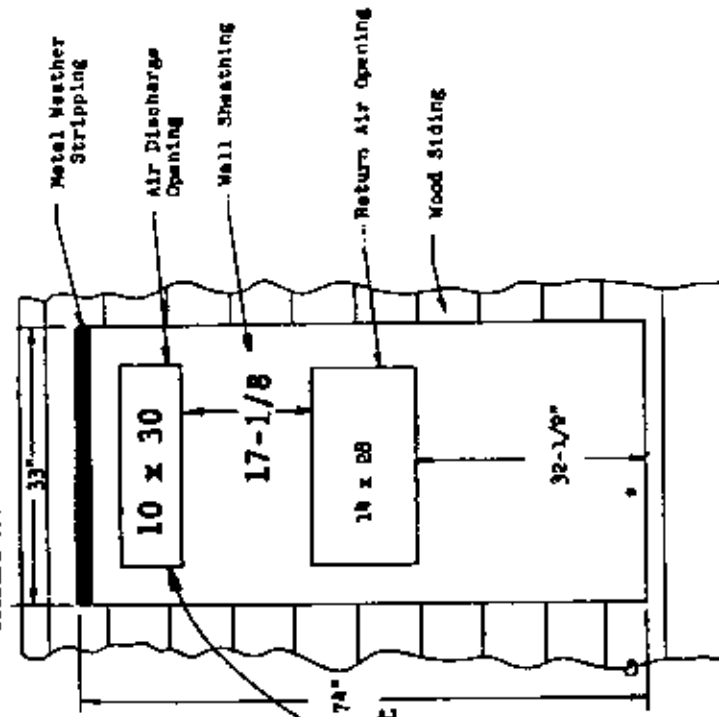
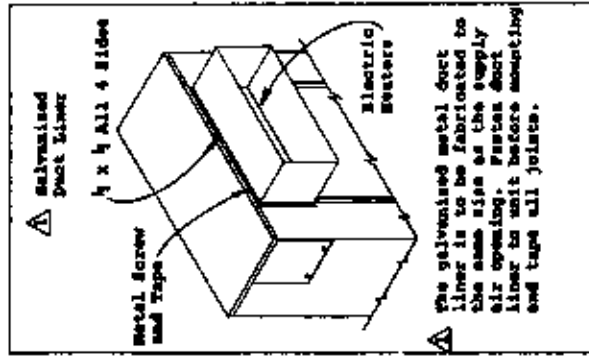
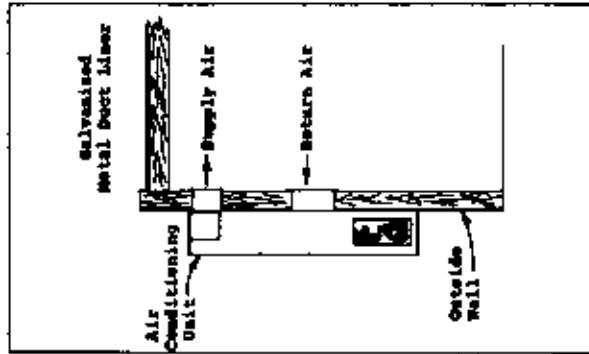

Fig. 2

SUPPLY AIR DUCT JOINT LINER
MODELS WA AND WZ

The cabinets on all models, with or without electric heaters, are approved for 0" clearance to combustible material. The outlet duct on all models with electric heaters must have 1" clearance to combustible materials for at least the first 3 feet of duct.

Whenever a model WA or WZ is installed, a galvanized metal duct liner must always be attached (Fig. 3). Before installing, determine the wall thickness. If the installation is free air flow, with no external duct, then the liner should be cut flush with the inside wall opening. In order to insure no sweating, the duct liner should be wrapped with a minimum of 1" insulation.



COOLING AND HEATING ANTICIPATORS FOR WALL THERMOSTATS

All 24V wall thermostats are built with both cooling and heating anticipators. The purpose of these anticipators is to compensate the thermostat for various system controls and allow the best possible cycle rates.

The cooling anticipator for all thermostats, and the heating anticipator on a limited number, are fixed and require no adjustment. Most heating anticipators are adjustable and DO NOT REQUIRE ADJUSTMENT to match the current rating of the relay, contactor or other control being cycled by that heating stage. In the case of a two stage heating thermostat there will be an anticipator for each stage, either both adjustable, one fixed and one adjustable, or both fixed.

The fixed anticipators are rated for a maximum of 1.5A. The adjustable anticipators generally have a range of .2 - 1.2A, and MUST BE ADJUSTED. Failure to adjust the anticipator lever to correspond to the actual current draw passing through that stage mercury switch and anticipator will cause severe short cycling conditions if set too low and room temperature may never attain the thermostat set point, and if set too high, will cause room temperature over-shoot.

While oil burner primary controls and gas valves are normally marked with the nominal current rating, the contactors and relays installed in air conditioners and heat pumps are not. Listed below are some of the more popularly used controls and their nominal current ratings.

| Contactors or Relay | Nominal Current Rating |
|-------------------------|------------------------|
| Rooswell - R3008 Series | .55 |
| - R3110 Series | .60 |
| - R3211 Series | .60 |
| - R3214 Series | .60 |
| - R3122 Series | .38 |
| - R3218 Series | .38 |
| - R3242 Series | .38 |
| - R3263 Series | .38 |
| NRK - Type 84 | .17 |
| - Type 91 | .34 |
| - Type 112 | .34 |
| - Type 143 | .34 |
| - Type 154 | .36 |
| - Type 184 | .32 |
| Siemco - 307020 | .39 |
| - 307029 | .39 |
| - 307028 | .39 |
| - 307029 | .31 |
| - 307038 | .31 |
| - 307038 | .31 |
| - 307036 | .21 |

Below is a procedure which allows accurate low amperage current measurements with a standard clamp-on ammeter with a 0-5A range. It is actually recommended that this measurement always be taken, since variations in voltage, thermostat wire length, etc. can all cause some change in current draw.

1. Wrap exactly 10 loops of thermostat wire (W1) around the prongs of an Amprobe.
2. Let the heating system operate for one minute before reading the W1 or W2 current draw.
3. Divide the reading obtained in Step 1 by 10.
4. Use the value calculated in step 3 to set the heat anticipator.
5. Repeat the procedure for (W2) if 2-stage heat.



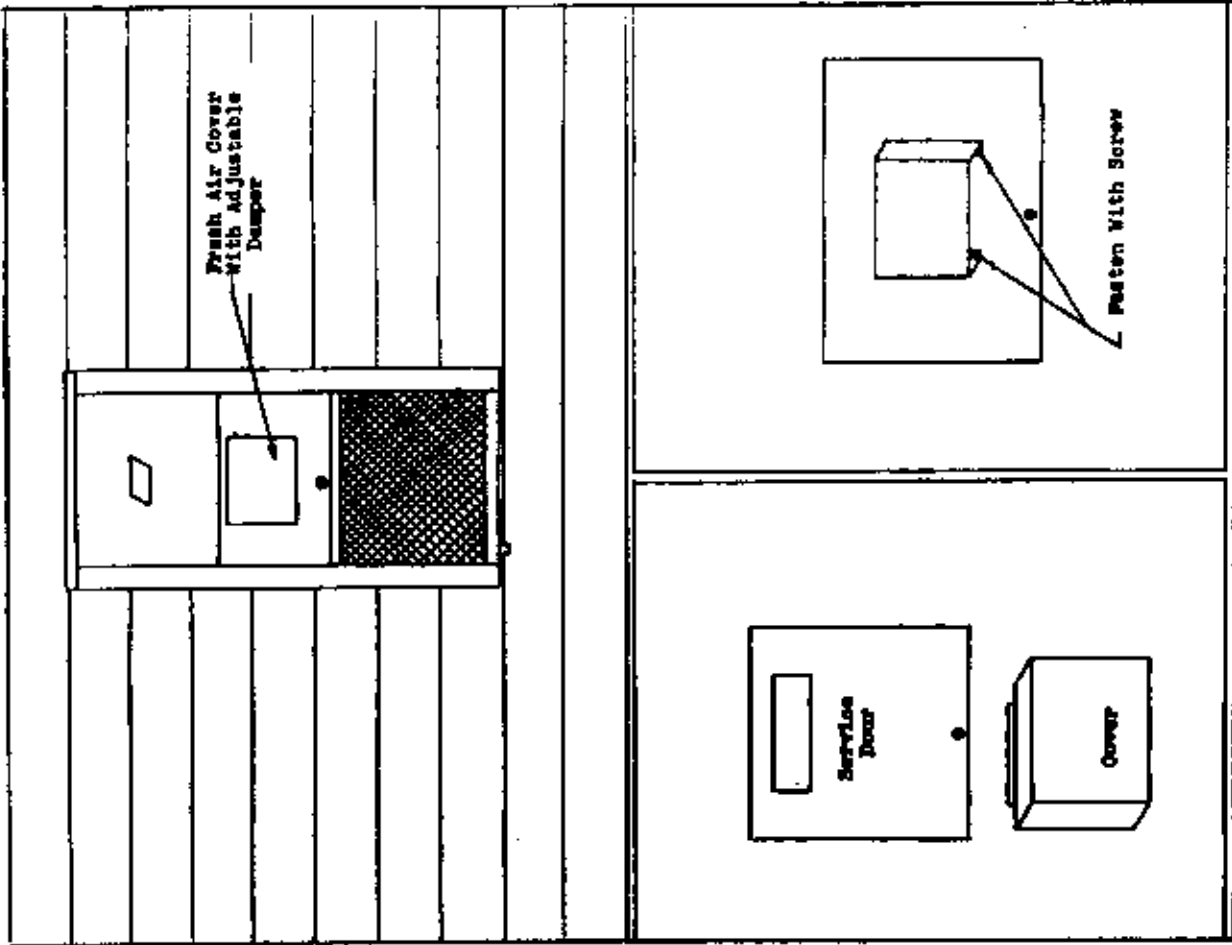
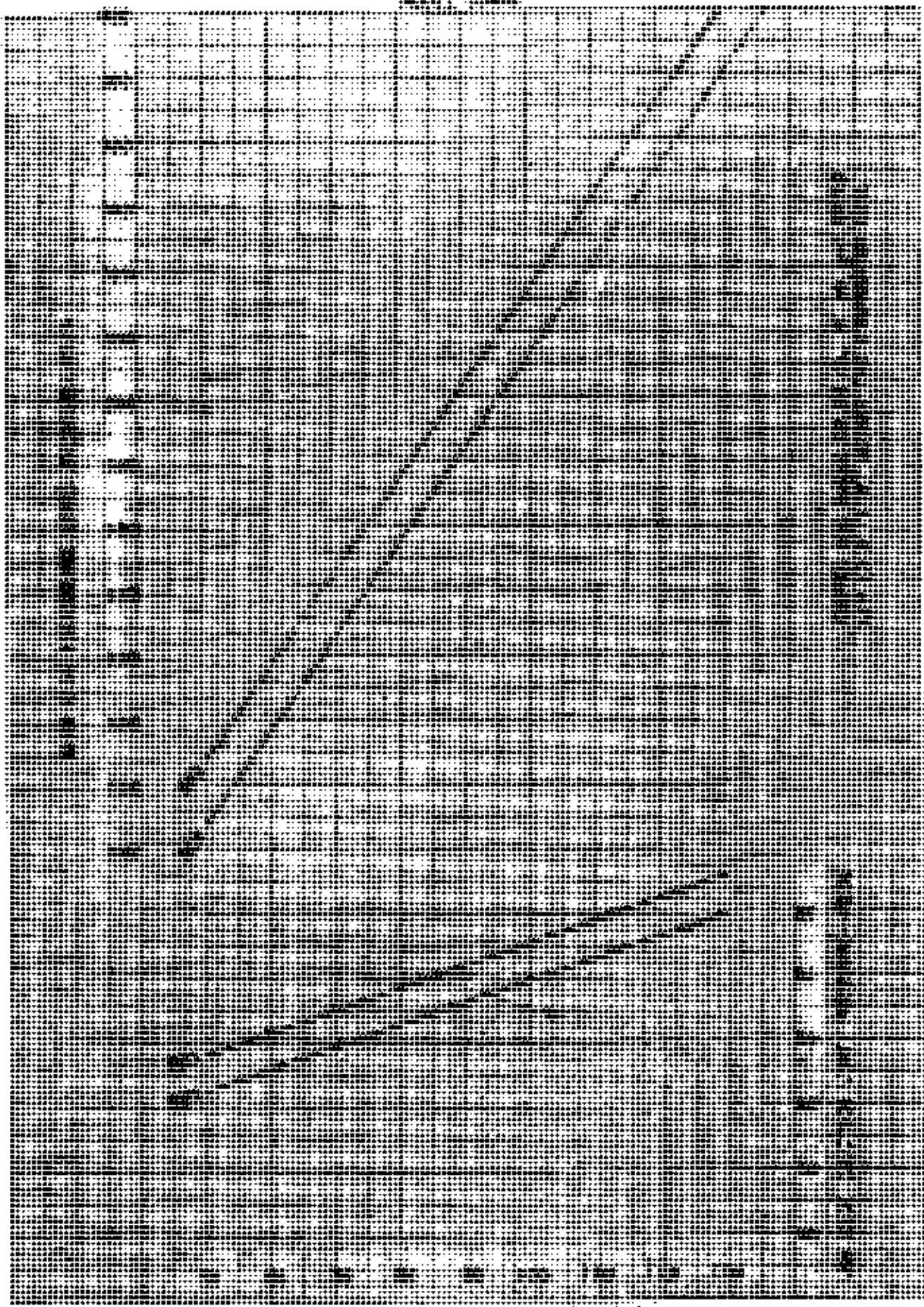
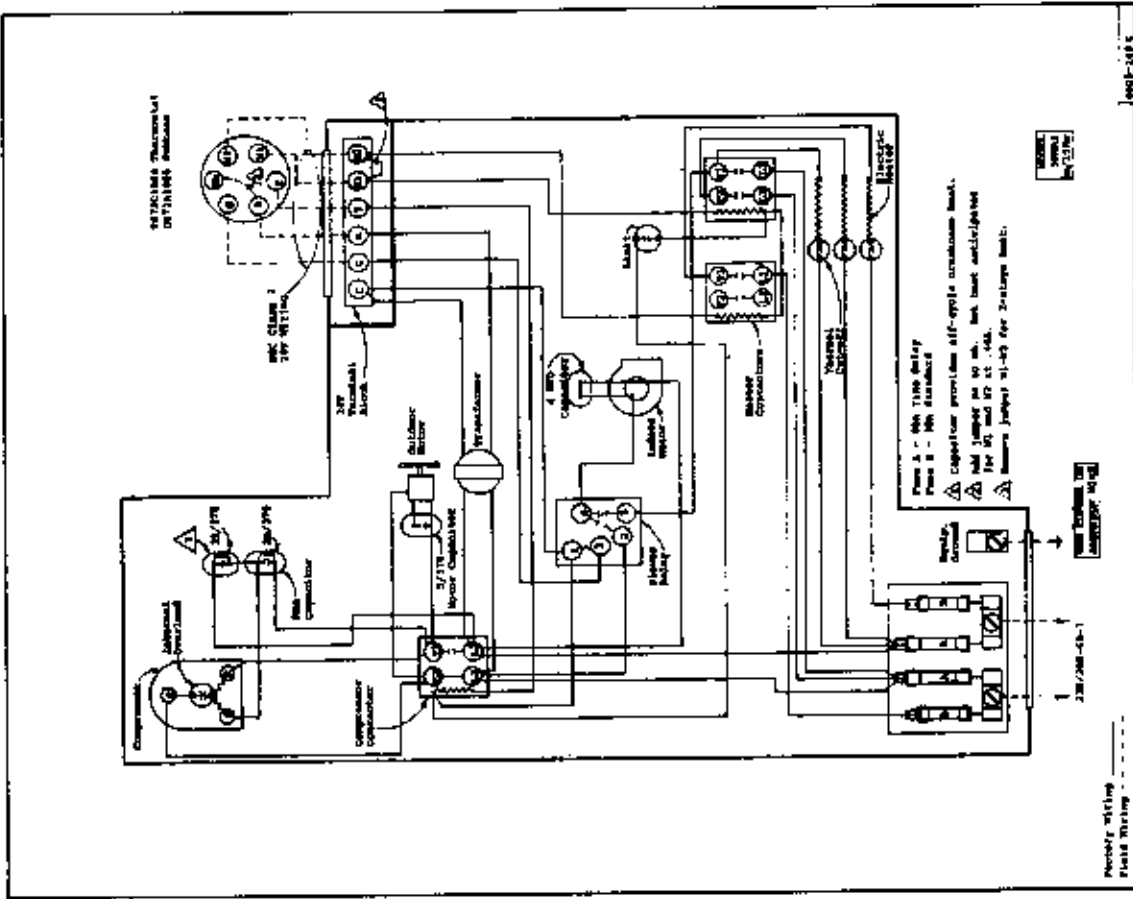
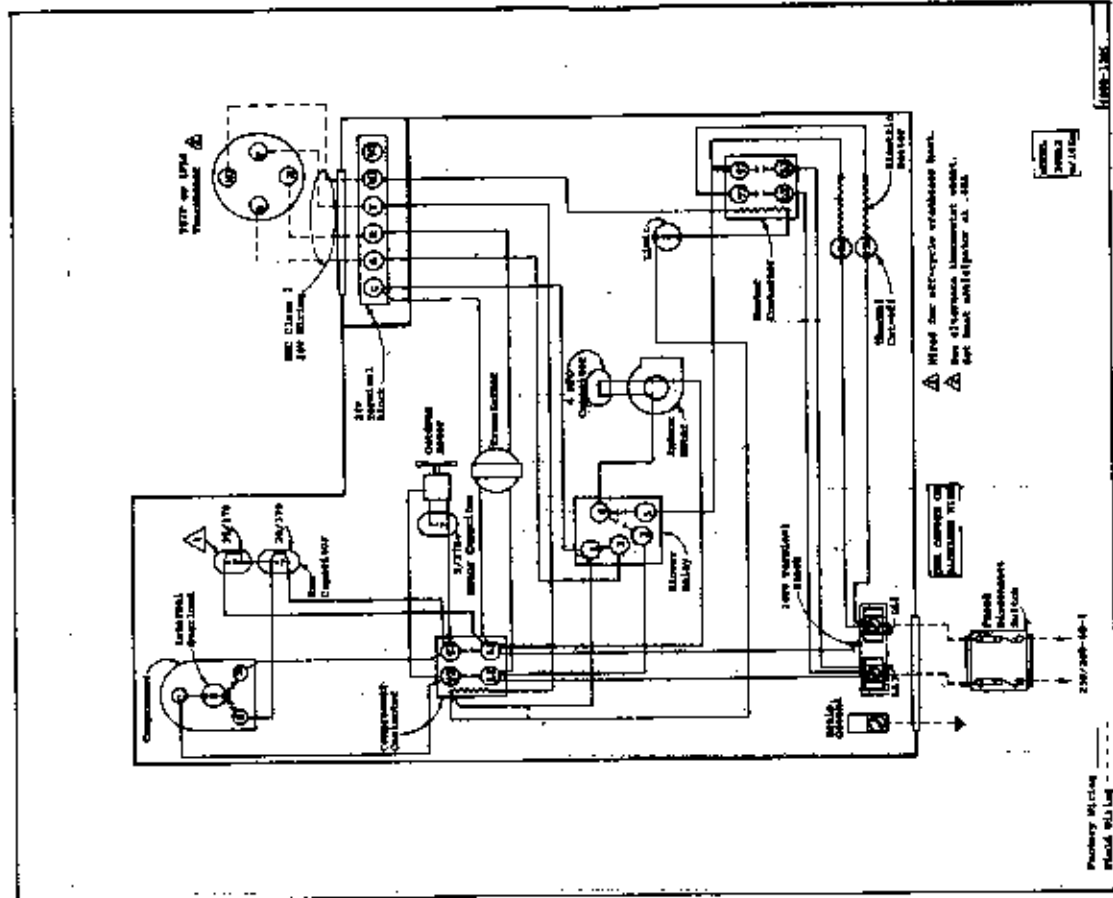
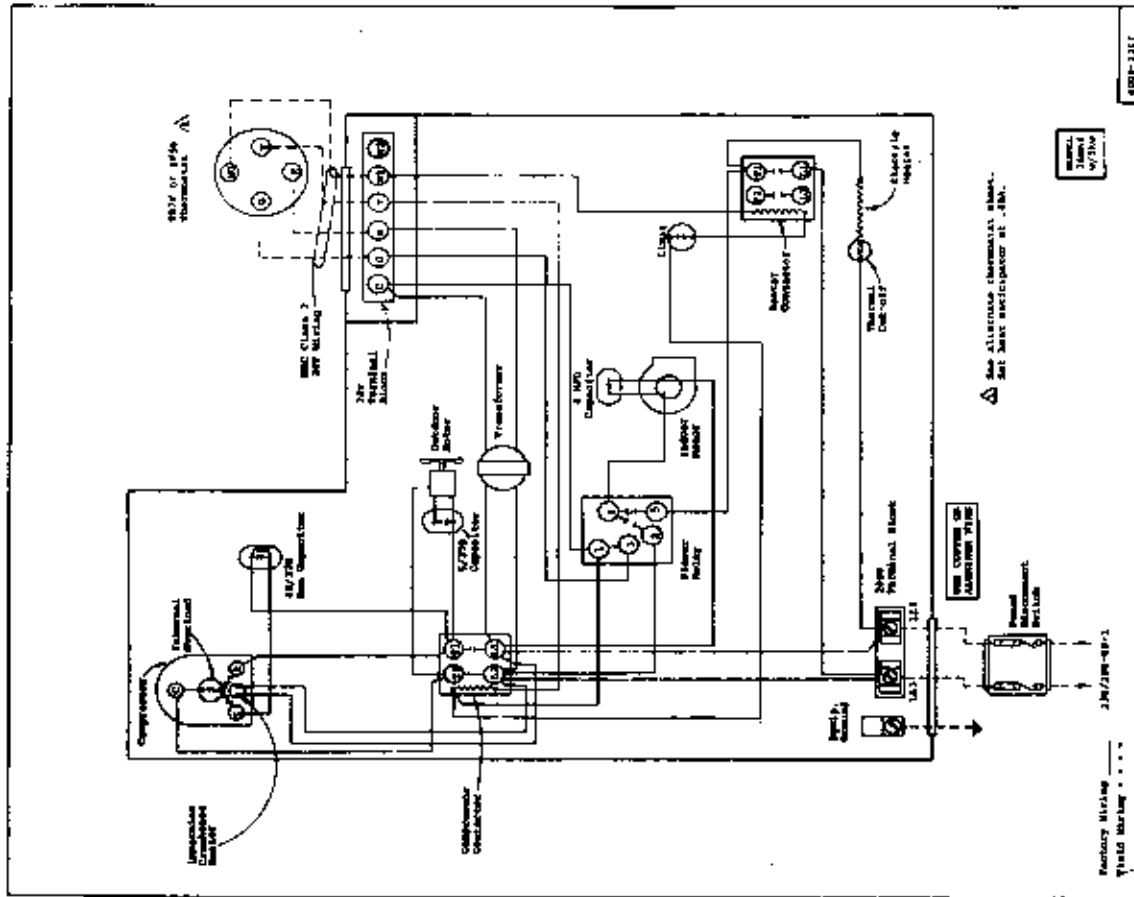
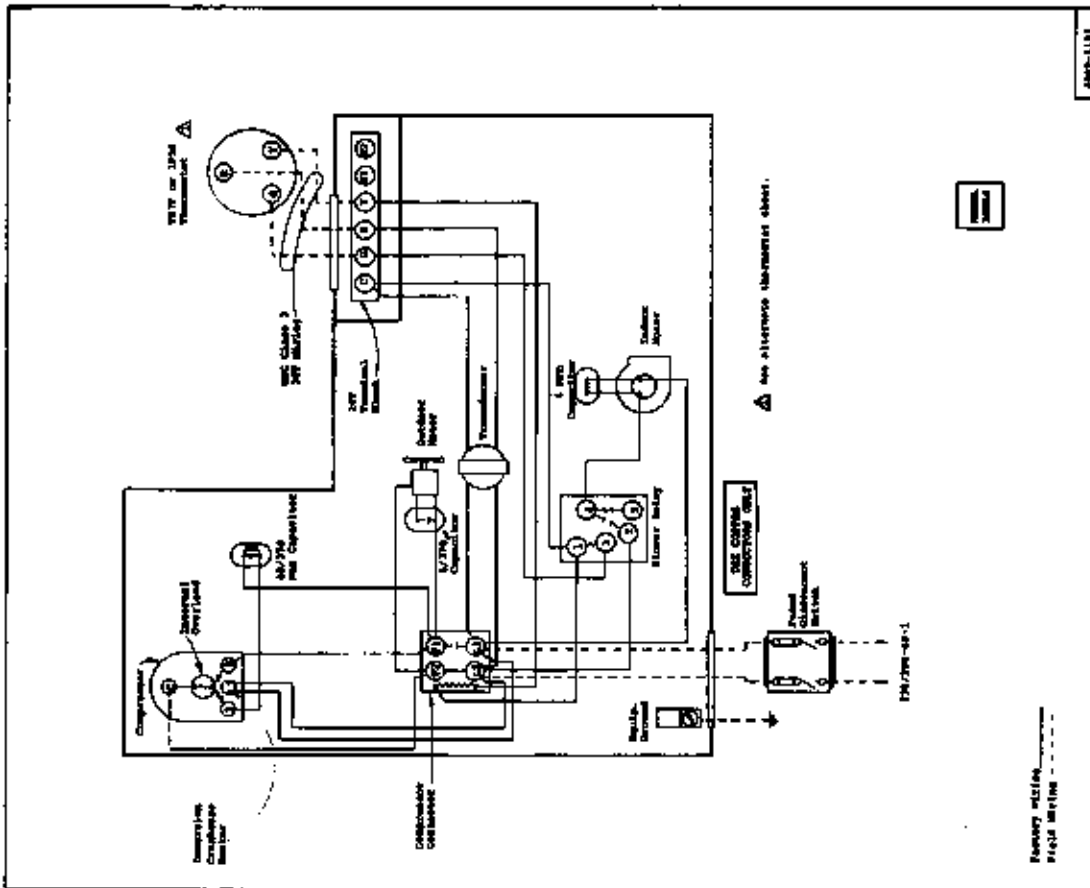

Fig. 3



[The main body of the document is a dense grid of black and white dots, likely representing a corrupted or redacted page of text. The grid is approximately 800x800 units in size.]





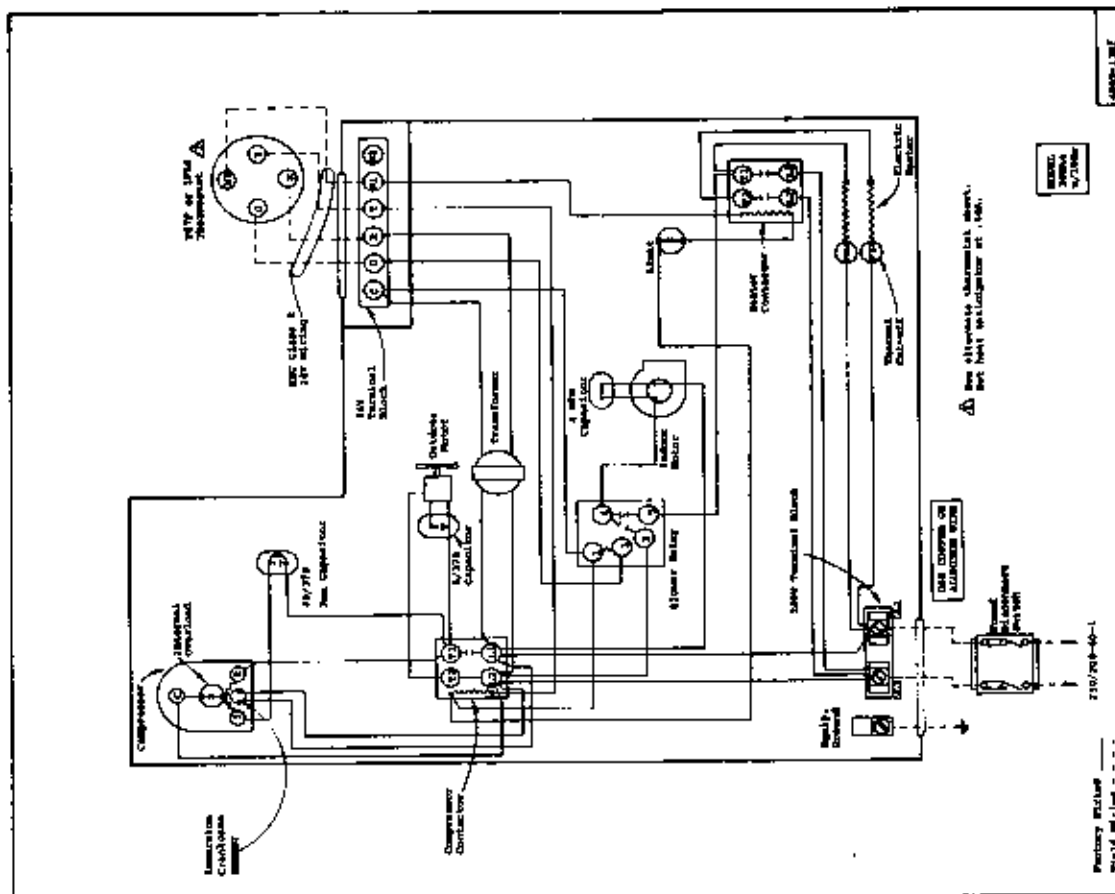
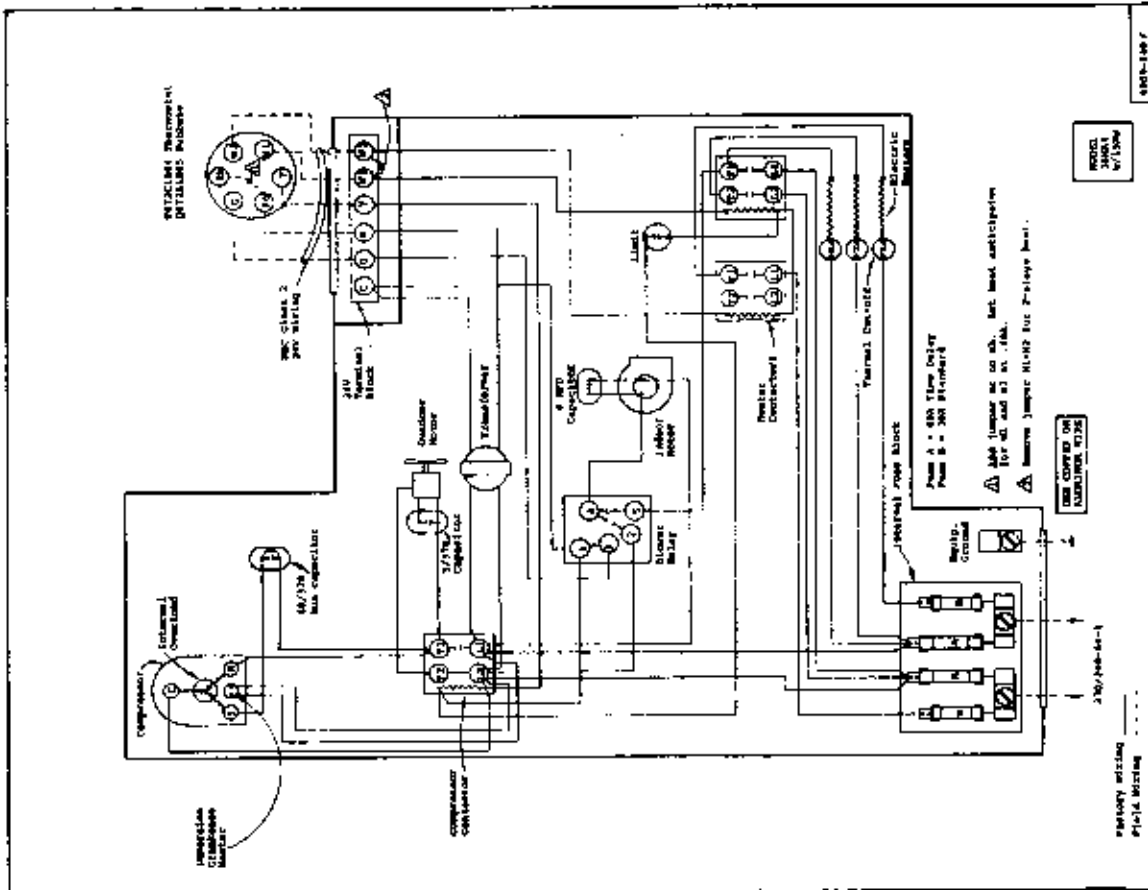

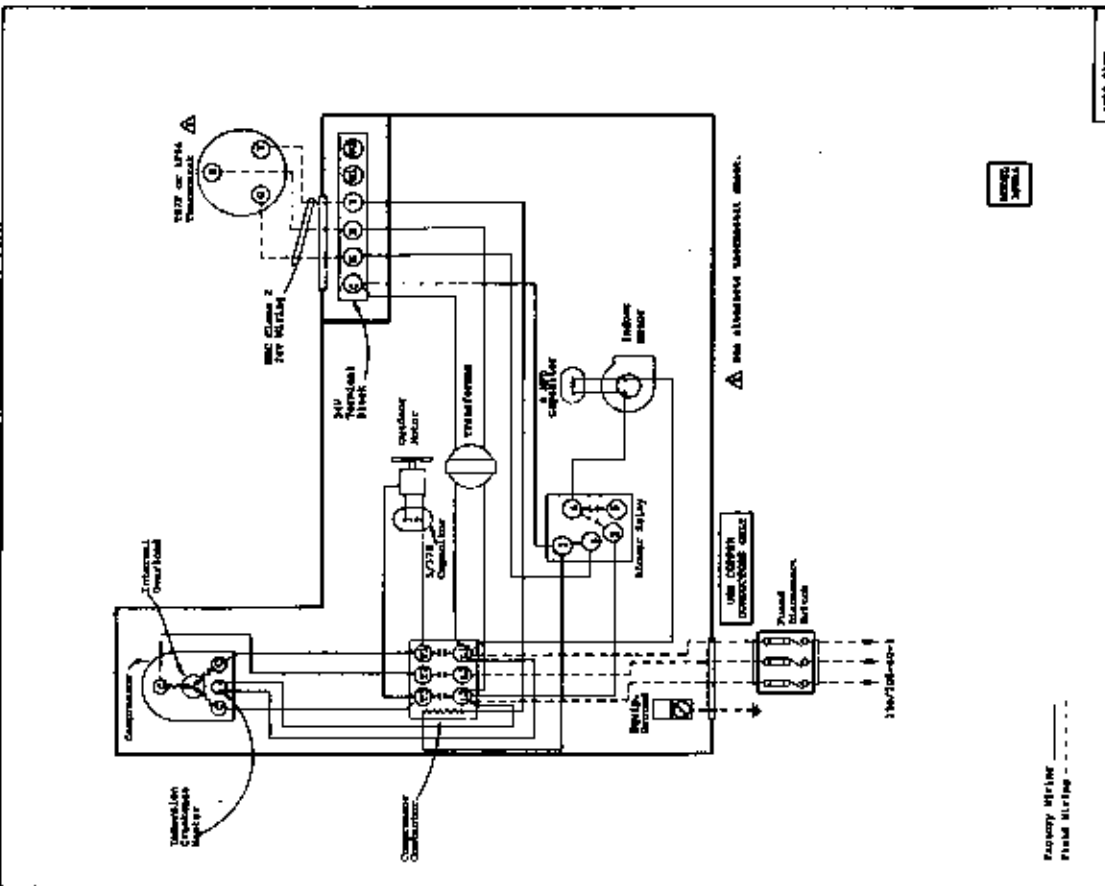
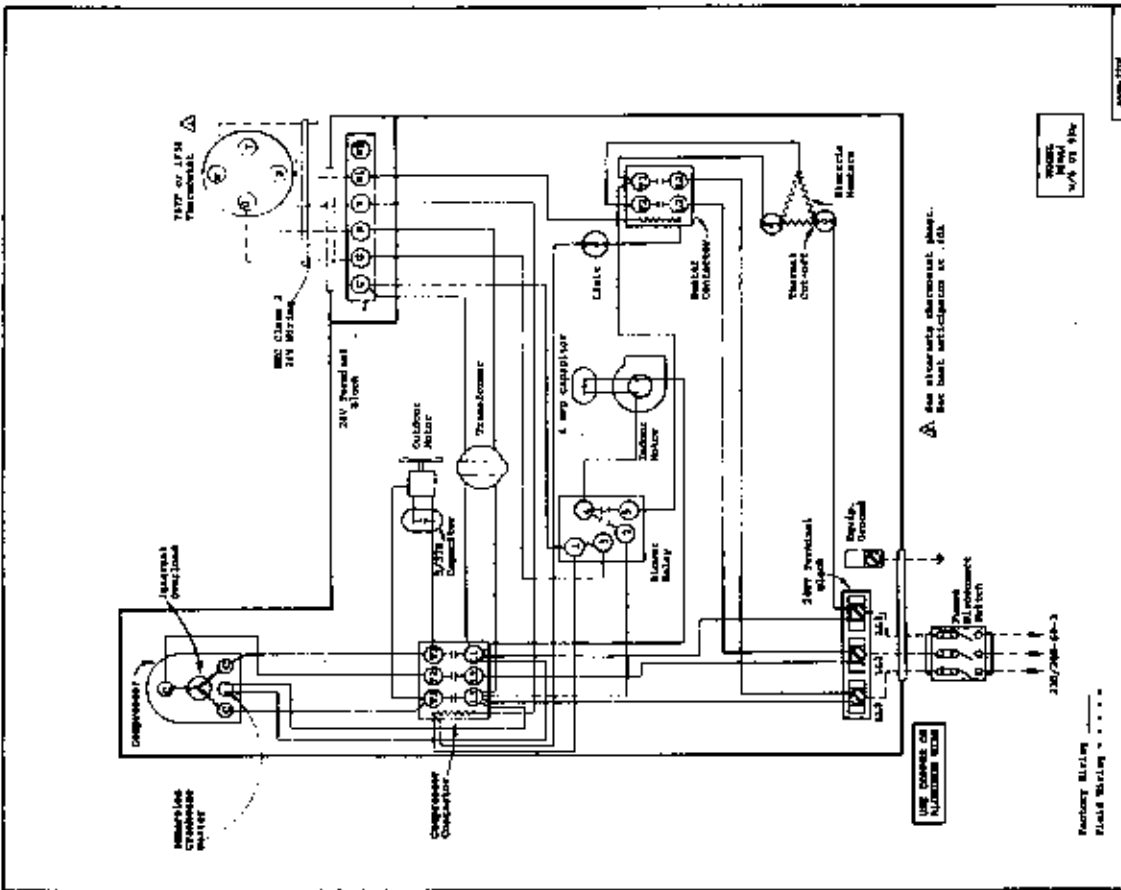

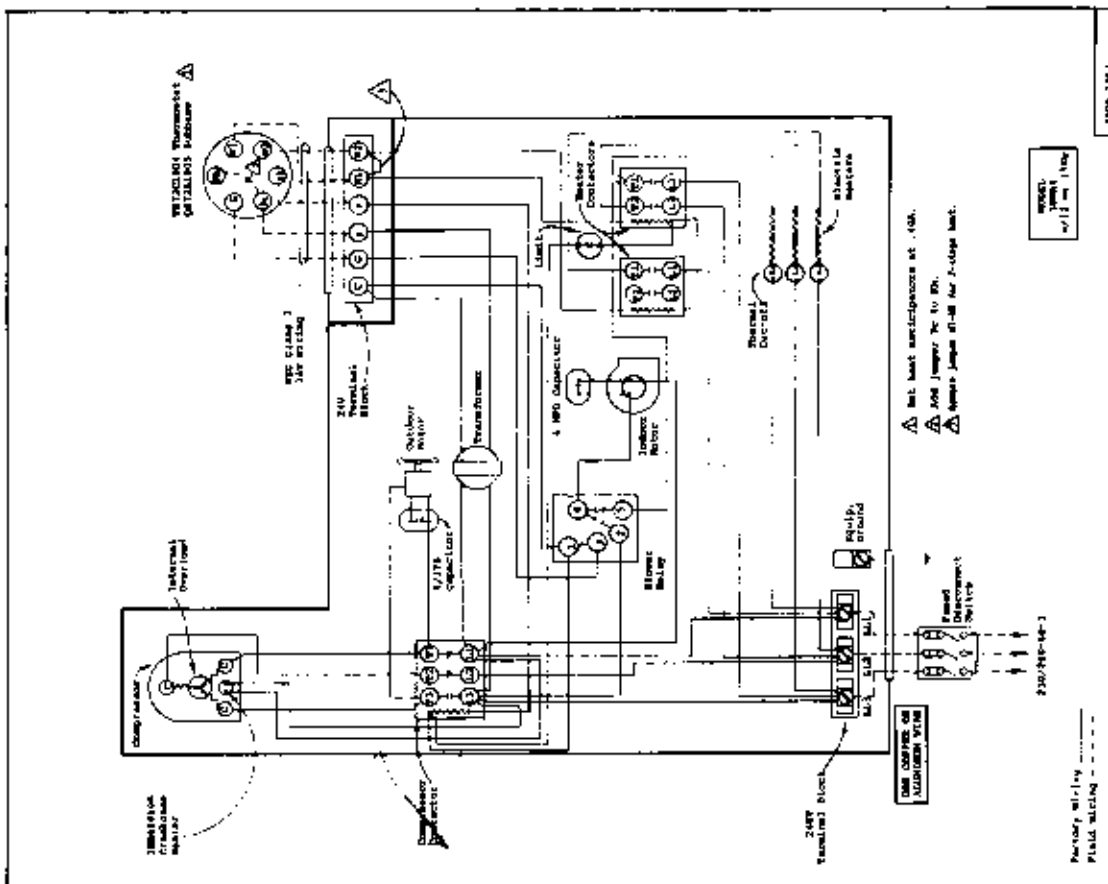
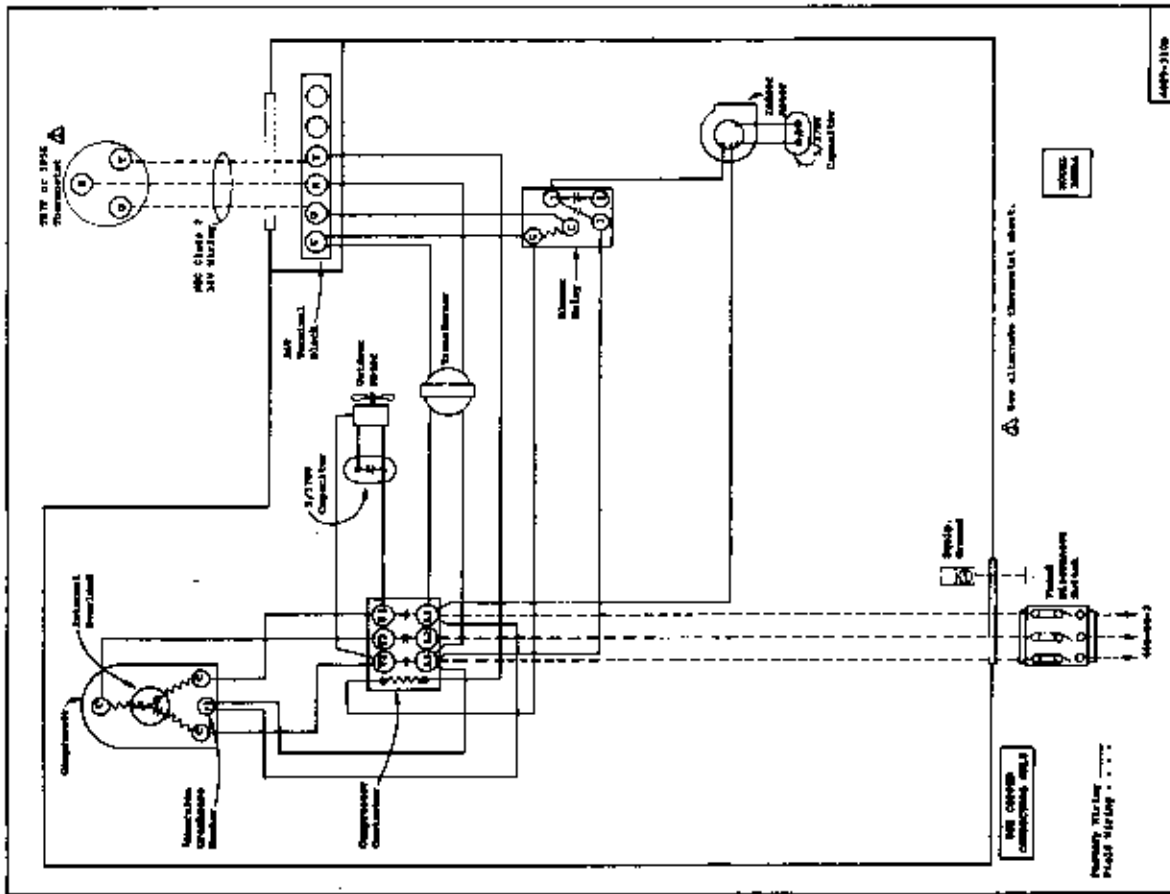

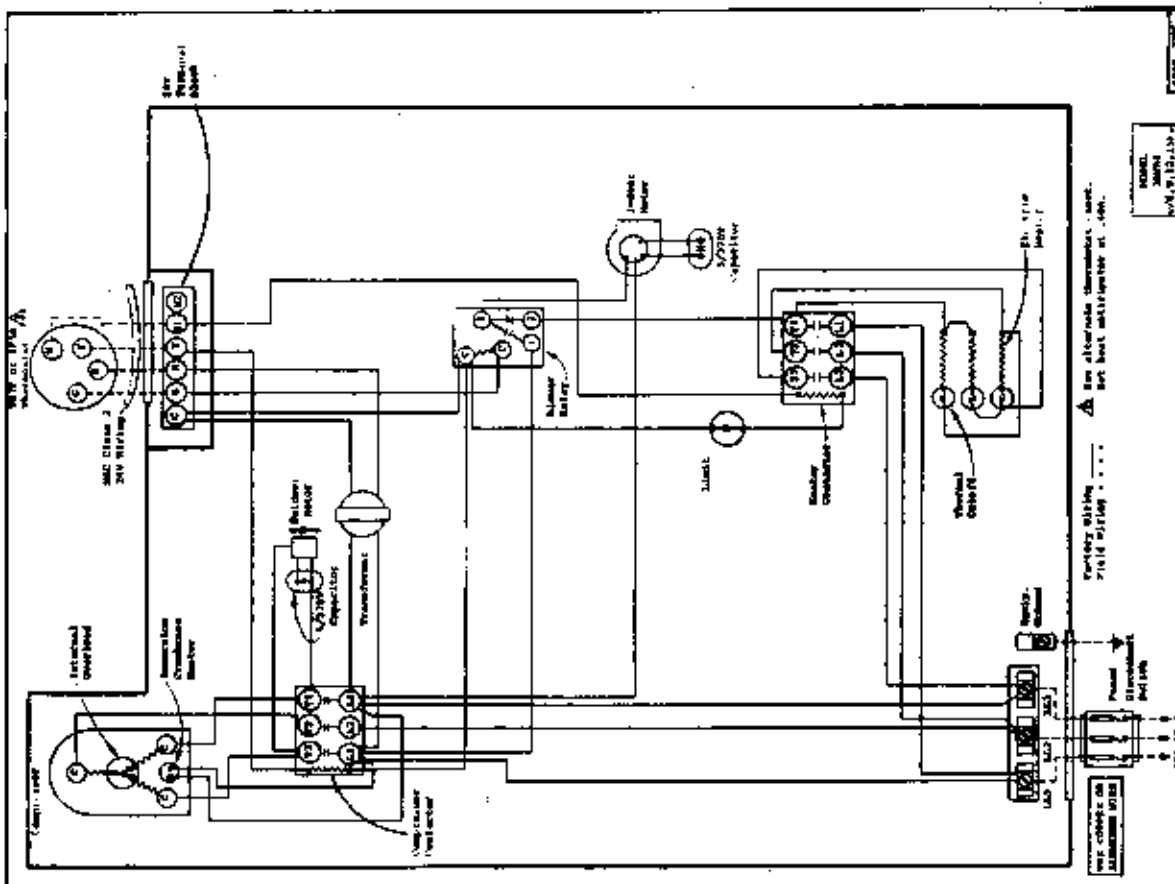

PARTS LIST
SINGLE PACKAGE AIR CONDITIONERS

| PART NO. | DESCRIPTION | 30WA2 | 36WA4 | 36WA4-3 | 36WA4-3 460V |
|----------|--------------------------------|-------|-------|---------|-----------------|
| 5152-030 | Blower Housing 9-7 | x | x | x | x |
| 5152-028 | Blower Wheel 9-7 | x | x | x | x |
| 5152-029 | Blower Wheel 9-7 | x | x | x | x |
| 8552-022 | Capacitor 20/370V | x | | | |
| 8552-020 | Capacitor 35/370V | x | | | |
| 8552-024 | Capacitor 40/370V | | x | | |
| 8552-002 | Capacitor 5/370V | x | x | x | x |
| 5811-014 | Cap Tube - Cool 37-1/2" x .070 | (2) | | | |
| 5811-033 | Cap Tube - Cool 32" x .070 | | (2) | (2) | (2) |
| 8000-042 | Compressor H2EA293AB | x | | | |
| 8000-055 | Compressor CRH1-0275-PFV-270 | | x | | |
| 8000-056 | Compressor CRH1-0275-TF5-270 | | | x | |
| 8000-057 | Compressor CRH1-0275-TFD-270 | | | | x |
| 5051-020 | Condenser Coil | x | | | |
| 5051-023 | Condenser Coil | | x | x | x |
| 8401-007 | Contactator - Comp. 1P25A | x | x | | |
| 8401-002 | Contactator - Comp. 3P25A | | | x | x |
| 8401-006 | Contactator - Heater 2P18A | x | x | x | |
| 5060-023 | Evaporator Coil | x | x | x | x |
| 5151-025 | Fan Blade F10H08-2027 cw | x | x | x | x |
| 7004-008 | Filter 15 x 30-5/8 | x | x | x | x |
| 8614-006 | Fuse - Heater 30A | x | x | | |
| 8614-022 | Fuse - Compressor 60A | x | x | | |
| 8614-017 | Fuse Block 15Kw | x | x | | |
| 8604-042 | Heat Strip 5Kw | x | x | | |
| 8604-049 | Heat Strip 6Kw | | | x | |
| 8604-044 | Heat Strip 10Kw | x | x | | |
| 8604-048 | Heat Strip 9Kw | | | x | |
| 8604-046 | Heat Strip 12Kw | | | x | |
| 8604-047 | Heat Strip 15Kw | x | x | x | |
| 8604-050 | Heat Strip 9Kw | | | | x |
| 8604-051 | Heat Strip 12Kw | | | | x |
| 8604-052 | Heat Strip 15Kw | | | | x |
| 8402-031 | Limit Switch LT55-2.5 | x | x | x | x |
| 8105-019 | Motor - Blower 1/3 hp | x | x | x | |
| 8105-015 | Motor - Blower 1/3 hp | | | | x |
| 8105-020 | Motor - Fan 1/3 hp | x | x | x | |
| 8105-016 | Motor - Fan 1/3 hp | | | | x |
| 8200-001 | Motor Mount - Fan | x | x | x | x |
| 8201-009 | Relay - Blower | x | x | x | |
| 8201-032 | Relay - Blower | | | | x |
| 5210-004 | Strainer | x | x | x | x |
| 8607-006 | Terminal Board 24V | x | x | x | x |
| 8607-001 | Terminal Block 230V | x | x | | |
| 8607-002 | Terminal Block | | | x | x |
| 8607-007 | Terminal Board | | | | x |
| 8402-032 | Thermal Cut-off | x | x | x | x |
| 8407-007 | Transformer | x | x | | |
| 8407-015 | Transformer | | | x | |
| 8407-027 | Transformer | | | | x |
| 8552-003 | Capacitor 6/370V | x | x | | |
| 8552-001 | Capacitor 4/370V | | | x | x |

IMPORTANT

PURCHASER'S RESPONSIBILITIES

Below are the responsibilities of the purchaser and these items cannot be considered as defects in workmanship or material.

1. Air filter cleaning or replacement.
2. Failure to operate due to improper air distribution over indoor and outdoor equipment sections.
3. Failure to start due to voltage conditions, blown fuses or other damage due to inadequacy or interruption of electrical service.
4. Damage caused directly or indirectly by improper installation.
5. Damage due to lack of proper and periodic maintenance.
6. Damage resulting from transportation, moving or storage of unit.
7. Unit must be readily accessible for servicing and/or repair at all times.
8. Any adjustment or service to the unit should be made by qualified service personnel.
9. Misapplication of product.

MODEL NO. _____ SERIAL NO. _____ DATE
INSTALLED _____

INSTALLER: Please fill in above blanks and leave
this manual with equipment owner/operator.