



# THE WALL-MOUNT™ AIR CONDITIONERS - 10.0 EER, (50HZ)

**Models W24AA to W72AB Right Side Control Panel**  
**Models W24LA to W72LB Left Side Control Panel**  
**22,400 Btuh (6.56 KW) – 64,700 Btuh (18.96 KW)**

**FOR EXPORT  
ONLY**

The Bard Wall-Mount Air Conditioner is a self contained energy efficient system, which is designed to offer maximum indoor comfort at a minimal cost without using valuable indoor floor space or outside ground space. This unit is the ideal product for versatile applications such as: new construction, modular offices, school modernization, telecommunication structures, portable structures or correctional facilities. Factory or field installed accessories are available to meet specific job requirements.

## Engineered Features

### Aluminum Finned Copper Coils:

Grooved tubing and enhanced louvered fin for maximum heat transfer and energy efficiency.

### Twin Blowers:

Move air quietly. Most models feature multispeed blower motors providing airflow adjustment for high and low static operation. Motor overload protection is standard on all models.

### Air Conditioner Compressor:

Scroll Compressors eliminate need for crankcase heater. Standard on all models, except 5-Ton.

### R-410A Refrigerant:

Designed with R-410A (HFC) non-ozone depleting refrigerant in compliance with the Montreal protocol and 2010 EPA requirements.

### Phase Rotation Monitor:

Standard on all 3 phase scroll compressors. Protects against reverse rotation if power supply is not properly connected. Rotation protection is not required on the 5-Ton Unit(s).

### Galvanized 20 Gauge Zinc Coated Steel Cabinet:

Cleaned, rinsed, sealed and dried before the polyurethane primer is applied. The cabinet is handsomely finished with a baked on textured enamel, which allows it to withstand 1000 hours of salt spray tests per ASTM B117-03.

### Foil Faced Insulation:

Standard on all units.

### Full Length Mounting Brackets:

Built into cabinet for improved appearance and easy installation.

**NOTE:** Bottom mounting bracket included to assist in installation.

### Electrical Components:

Are easily accessible for routine inspection and maintenance through a right side, service panel opening. Features a lockable, hinged access cover to the circuit breaker or toggle disconnect switch.

### Electric Heat Strips:

Features an automatic limit and thermal cut-off safety control.

### Filter Service Door:

Separate service door provides easy access for filter change.

### One Inch, Disposable Air Filters:

Are standard equipment. Optional one inch washable filters available and filter racks permit the addition of 2" pleated filter. Factory or field installed.

### Condenser Fan and Motor

#### Shroud Assembly:

Slides out for easy access.

### Barometric Fresh Air Damper:

Standard on all units. Allows up to 25% outside fresh air. Optional ventilation packages available.

### Built-in Circuit Breakers:

Standard on all electric heat versions of single (230/208 volt) and three phase (230/208 volt) equipment. Toggle disconnects are standard on all electric heat versions of three phase (460 volt) equipment.

### Slope Top:

Standard feature for water run-off.

### Top Rain Flashing:

Standard feature on all models.

### Liquid Line Filter Drier:

Standard on all units. Protects system against moisture.



### Compressor Control Module:

Standard on all units. Built-in off-delay timer adjustable from 30 seconds to 5 minutes. 2-minute on-delay if power interrupt. 120-second bypass for low pressure control, and both soft and manual lockouts for high and low pressure controls. Alarm output for alarm relay.

### High & Low Pressure Switches are Auto-Reset:

Standard on all units. Built-in lockout circuit resets from the room thermostat. Provides commercial quality protection to the compressor.

Bard is an  
ISO 9001:2015  
Certified Manufacturer

## Capacity and Efficiency Ratings

Models	W24AA W24LA	W30AA W30LA	W36AA W36LA	W42AA W42LA	W48AA W48LA	W60AB W60LB	W72AB W72LB
Cooling Capacity BTUH	22,400	27,300	33,300	37,800	43,700	50,100	64,700
Cooling Capacity KW	6.56	8.00	9.75	11.07	12.80	14.68	18.96
EER	10.00	10.00	10.00	10.00	10.00	10.00	10.00

All capacity, efficiency and cost of operation is based on high speed operation with fresh air cover plate. Cover plate must be ordered separately and is recommended for use to obtain maximum energy efficiency where fresh air is not required.

## Specifications 22,400 Btuh (6.56 KW) — 33,300 Btuh (9.75 KW)

MODELS	W24AA-D	W24AA-F W24LA-F	W30AA-D	W30AA-F W30LA-F	W36AA-D	W36AA-E	W36AA-F W36LA-F
<b>Electrical Rating – 50 Hz</b>	240/220 - 1	415/380 - 3 ①	240/220 - 1	415/380 - 3 ①	240/220 - 1	220/200 - 3	415/380 - 3 ①
Operating Voltage Range	198-254	342-456	198-254	342-456	198-254	180-242	342-456
<b>Compressor--Circuit A</b>							
Voltage	240/220	415/380	240/220	415/380	240/220	220/200	415/380
Rated Load Amps	7.9/9.1	3.7/4.3	8.1/9.2	3.1/3.6	12/13.5	9.9/11.1	4.5/5.1
Branch Circuit							
Selection Current	10.9	5.1	12.2	4.7	16.0	13.2	6.0
Lock Rotor Amps	60/60	28/28	67/67	38/38	87/87	95/95	46/46
Compressor Type	Scroll	Scroll	Scroll	Scroll	Scroll	Scroll	Scroll
<b>Fan Motor &amp; Condenser</b>							
Fan Motor--HP--RPM	1/5 - 1090	1/5 - 1090	1/5 - 1075	1/5 - 1075	1/5 - 1075	1/5 - 1075	1/5 - 1075
Fan Motor--Amps	1.2	1.2	1.5	1.5	1.5	1.5	1.5
Fan--DIA m <sup>3</sup> /s	458/0.68	458/0.68	508/0.91	508/0.91	508/0.83	508/0.83	508/0.83
<b>Blower Motor &amp; Evap.</b>							
Blower Motor--HP-RPM-SPD	1/6-1100-1	1/6-1100-1	1/3-1100-2	1/3-1100-2	1/3-1100-2	1/3-1100-2	1/3-1100-2
Blower Motor--Amps	1.0	0.8	2.1	2.1	2.1	2.1	2.1
m <sup>3</sup> /s Cooling & E.S.P. (pa) w/Filter (Rated-Wet Coil)	0.32/75	0.32/75	0.39/112	0.39/112	0.43/75	0.43/75	0.43/75
Filter Sizes (mm) STD.	405x635x25	405x635x25	405x765x25	405x765x25	405x765x25	405x765x25	405x765x25
<b>Basic Unit Weight-LBS. (Kg)</b>	335 (152)	335 (152)	350 (159)	350 (159)	380 (172)	380 (172)	380 (172)
Barometric Fresh Air Damper	3.5 (1.588)	3.5 (1.588)	4.0 (1.814)	4.0 (1.814)	4.0 (1.814)	4.0 (1.814)	4.0 (1.814)
Blank-Off Plate	1.0 (0.454)	1.0 (0.454)	1.0 (0.454)	1.0 (0.454)	1.0 (0.454)	1.0 (0.454)	1.0 (0.454)
Motorized Fresh Air Damper	10.0 (4.536)	10.0 (4.536)	11.0 (4.99)	11.0 (4.99)	11.0 (4.99)	11.0 (4.99)	11.0 (4.99)
Commercial Room Ventilator	69.0 (31.30)	69.0 (31.30)	75.0 (34.02)	75.0 (34.02)	75.0 (34.02)	75.0 (34.02)	75.0 (34.02)
Economizer	69.0 (31.30)	69.0 (31.30)	75.0 (34.02)	75.0 (34.02)	75.0 (34.02)	75.0 (34.02)	75.0 (34.02)

## Specifications 37,800 Btuh (11.07 KW) — 64,700 Btuh (18.95 KW)

MODELS	W42AA-E	W42AA-F W42LA-F	W48AA-E	W48AA-F W48LA-F	W60AB-E	W60AB-F W60LB-F	W72AB-F W72LB-F
<b>Electrical Rating – 50 Hz</b>	220/200 - 3	415/380 - 3 ①	220/200 - 3	415/380 - 3 ①	220/200 - 3	415/380 - 3 ①	415/380 - 3 ①
Operating Voltage Range	180-242	342-456	180-242	342-456	180-242	342-456	342-440
<b>Compressor--Circuit A</b>							
Voltage	220/200	415/380	220/200	415/380	220/200	415/380	415/380
Rated Load Amps	10.2/11.4	4.6/5.1	17.3/19.6	5.1/5.7	13.1/15.0	7.1/7.6	8.0/8.8
Branch Circuit							
Selection Current	13.6	6.1	14.5	6.3	15.6	7.8	10.6
Lock Rotor Amps	80.7/80.7	43/43	94/94	52/52	110/110	52/52	74/74
Compressor Type	Scroll	Scroll	Scroll	Scroll	Recip.	Recip.	Scroll
<b>Fan Motor &amp; Condenser</b>							
Fan Motor--HP--RPM	1/3 - 825	1/3 - 825	1/3 - 825	1/3 - 825	1/3 - 825	1/3 - 825	1/3 - 950
Fan Motor--Amps	2.6	2.6	2.6	2.6	2.5	2.5	4.0
Fan--DIA m <sup>3</sup> /s	610/1.10	610/1.10	610/1.13	610/1.13	610/1.17	610/1.17	610/1.51
<b>Blower Motor &amp; Evap.</b>							
Blower Motor--HP-RPM-SPD	1/3-985-2	1/3-985-2	1/3-985-2	1/3-985-2	1/2-1070-2	1/2-1070-2	3/4-1035-2
Blower Motor--Amps	2.3	2.3	2.3	2.3	3.5	3.5	6.3
m <sup>3</sup> /s Cooling & E.S.P. (pa) w/Filter (Rated-Wet Coil)	0.51/100	0.51/100	0.60/87	0.60/87	0.68/75	0.68/75	0.76/62
Filter Sizes (mm) STD.	508x765x25	508x765x25	508x765x25	508x765x25	508x765x25	508x765x25	508x765x25
<b>Shipping Weight --LBS. (Kg)</b>	465 (211)	465 (211)	475 (216)	475 (216)	545 (248)	545 (248)	545 (247)
Barometric Fresh Air Damper	4.5 (2.041)	4.5 (2.041)	4.5 (2.041)	4.5 (2.041)	4.5 (2.041)	4.5 (2.041)	4.5 (2.041)
Blank-Off Plate	1.0 (0.454)	1.0 (0.454)	1.0 (0.454)	1.0 (0.454)	1.0 (0.454)	1.0 (0.454)	1.0 (0.454)
Motorized Fresh Air Damper	11.5 (5.216)	11.5 (5.216)	11.5 (5.216)	11.5 (5.216)	11.5 (5.216)	11.5 (5.216)	11.5 (5.216)
Commercial Room Ventilator	91.5 (41.50)	91.5 (41.50)	91.5 (41.50)	91.5 (41.50)	91.5 (41.50)	91.5 (41.50)	91.5 (41.50)
Economizer	91.5 (41.50)	91.5 (41.50)	91.5 (41.50)	91.5 (41.50)	91.5 (41.50)	91.5 (41.50)	91.5 (41.50)

① 415/380-3 electrical ratings are 3-phase wye (star) systems requiring three (3) phase legs plus neutral and ground.

**NOTE:** The indoor & outdoor motors and 24V transformer primary are connected at 240V derived from one (1) phase leg to neutral. This is internally connected and no field wiring required.

## Ventilation System Packages

Bard Wall-Mounts are designed to provide optional ventilation packages to meet all of your ventilation and indoor air quality requirements. All units are equipped with a barometric fresh air damper as the standard ventilation package. All ventilation packages can be built-in at the factory or field-installed at a later date.

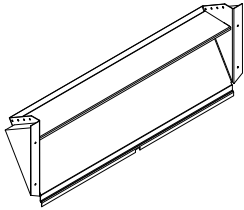

MS-3754  
**Barometric Fresh Air Damper**

### BAROMETRIC FRESH AIR DAMPER - WBFAD

**STANDARD**

The barometric fresh air damper is a standard feature on all models. It is installed on the inside of the service door and allows outside ventilation air, up to 25% of the total airflow rating of the unit, to be introduced through the air inlet openings and to be mixed with the conditioned air. The damper opens during blower operation and closes when the blower is off. Adjustable blade stops allow different amounts of outside air to be introduced into the building and can be easily locked closed if required.

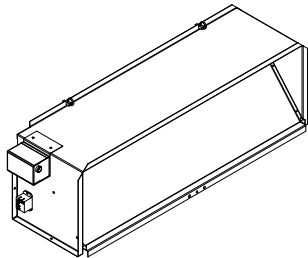

MS-3755  
**Motorized Fresh Air Damper**

### BLANK OFF PLATE - WBOP

**OPTIONAL**

A blank off plate is installed on the inside of the service door. It covers the air inlet openings, which restricts any outside air from entering the unit. The blank off plate should be utilized in applications where outside air is not required to be mixed with the conditioned air.

### MOTORIZED FRESH AIR DAMPER - WMFAD

**OPTIONAL**

The motorized fresh air damper is internally mounted behind the service door and allows outside ventilation air, up to 25% of the total airflow rating of the unit, to be introduced through the air inlet openings and to be mixed with the conditioned air. The two position damper can be fully open or closed. The damper blade is powered open by a 24VAC motor with spring return on power loss. The damper can be controlled by indoor blower operation or can be field connected to be managed based on building occupancy.

**NOTE:** The above vent systems are intake only without built-in exhaust capability. Building will likely require separate field installed barometric relief or mechanical exhaust elsewhere within the conditioned space. Balancing dampers in the return air grille may be required to achieve specified amount of outdoor air intake.

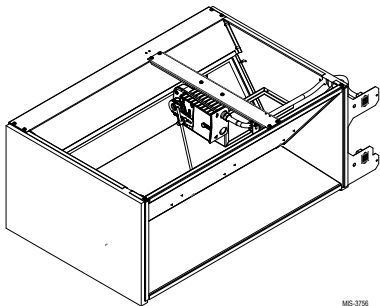

MS-3756  
**Commercial Room Ventilator**

### COMMERCIAL ROOM VENTILATOR - WCRV

**OPTIONAL**

The built-in commercial room ventilator is internally mounted behind the service door and allows outside ventilation air, up to 100% of the total airflow rating of the unit, to be introduced through the air inlet openings. It includes a built-in exhaust air damper.

The commercial room ventilator (CRV) is a simple and innovative approach to improving the indoor air quality by providing fresh air intake and exhaust capability through the CRV. The damper can be easily adjusted to control the amount of fresh air supplied into the building. The CRV can be controlled by indoor blower operation or field controlled based on room occupancy. The CRV is power open - spring return on power loss. Complies with ANSI/ASHRAE Standard 62.1 "Ventilation for Acceptable Indoor Air Quality".

#### Standard Features:

- Fully modulating
- Honeywell Hi-Torque Actuator
- No hood required
- Simple single blade design
- Positive shut-off with non-stick gaskets
- Solid State Controller with occupancy CFM setting

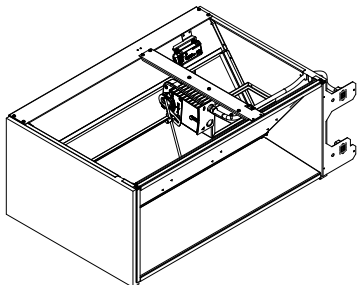

MS-3757  
**Economizer**

### ECONOMIZER – WECO Series

**OPTIONAL**

The built-in economizer system is internally mounted behind the service door and allows outdoor air to be introduced through the air inlet openings. The amount of outdoor air varies in response to the system controls and settings defined by the end user. It includes a built-in exhaust air damper. The economizer is designed to provide "free cooling" when outside air conditions are cool and dry enough to satisfy cooling requirements without running the compressor. This in turn provides lower operating costs, while extending the life of the compressor.

#### Standard Features:

- Full rated outdoor intake
- Fully modulating
- Honeywell Hi-Torque Actuator
- 7" intake hood with filter
- Simple single blade design
- Positive shut-off with non-stick gaskets
- Electronic DB and/or Enthalpy sensors depending upon version
- Honeywell JADE electronic economizer module with precision settings and diagnostics
- DB or Enthalpy economizer versions available

**Clearances - Inches (mm)  
Required for Service Access and  
Adequate Condenser Inlet Airflow**

MODELS	LEFT SIDE	RIGHT SIDE
W24AA, W30AA, W36AA	15" (380)	20" (510)
W42AA, W48AA, W60AB, W72AB	20" (510)	20" (510)

**Minimum Clearances - Inches (mm)  
Required to Combustible Materials**

MODELS ①	SUPPLY AIR DUCT FIRST THREE FEET (1m) CABINET	
	W24AA	0"
W30AA, W36AA	1/4" (6.35)	0"
W42AA, W48AA, W60AB, W72AB	1/4" (6.35)	0"

① Refer to the Installation Manual for more detailed information.

**Dimensions of Basic Unit for Architectural & Installation Requirements - Inches (mm)**

MODEL	WIDTH (W)	DEPTH (D)	HEIGHT (H)	SUPPLY		RETURN																
				A	B	C	B	E	F	G	I	J	K	L	M	N	O	P	Q	R	S	T
W24AA	33.300 (845)	17.125 (435)	74.563 (1894)	7.88 (200)	19.88 (505)	11.88 (302)	19.88 (505)	35.00 (889)	10.88 (276)	29.75 (756)	20.56 (522)	30.75 (781)	32.06 (814)	33.25 (845)	31.00 (787)	2.63 (67)	34.13 (867)	26.06 (662)	10.55 (268)	4.19 (106)	12.00 (305)	9.00 (229)
W30AA W36AA	38.200 (970)	17.125 (435)	74.563 (1894)	7.88 (200)	27.88 (708)	13.88 (353)	27.88 (708)	40.00 (1016)	10.88 (276)	29.75 (756)	17.93 (455)	30.75 (781)	32.75 (832)	33.25 (845)	31.00 (787)	2.75 (70)	39.13 (994)	26.75 (679)	9.14 (232)	4.19 (106)	12.00 (305)	9.00 (229)
W42AA W48AA	42.075 (1069)	22.432 (570)	84.875 (2156)	9.88 (251)	29.88 (759)	15.88 (403)	29.88 (759)	43.88 (1115)	13.56 (344)	31.66 (804)	30.00 (762)	32.68 (830)	26.94 (684)	34.69 (881)	32.43 (824)	3.37 (86)	43.00 (1092)	23.88 (607)	10.00 (254)	1.44 (37)	16.00 (406)	1.88 (48)
W60AB W72AB	42.075 (1069)	22.432 (570)	93.000 (2362)	9.88 (251)	29.88 (759)	15.88 (403)	29.88 (759)	43.88 (1115)	13.56 (344)	37.00 (940)	30.00 (762)	40.81 (1037)	35.06 (891)	42.81 (1087)	40.56 (1030)	3.37 (86)	43.00 (1092)	31.00 (787)	10.00 (254)	1.44 (37)	16.00 (406)	10.00 (254)

**W24AA - W72AB Models**

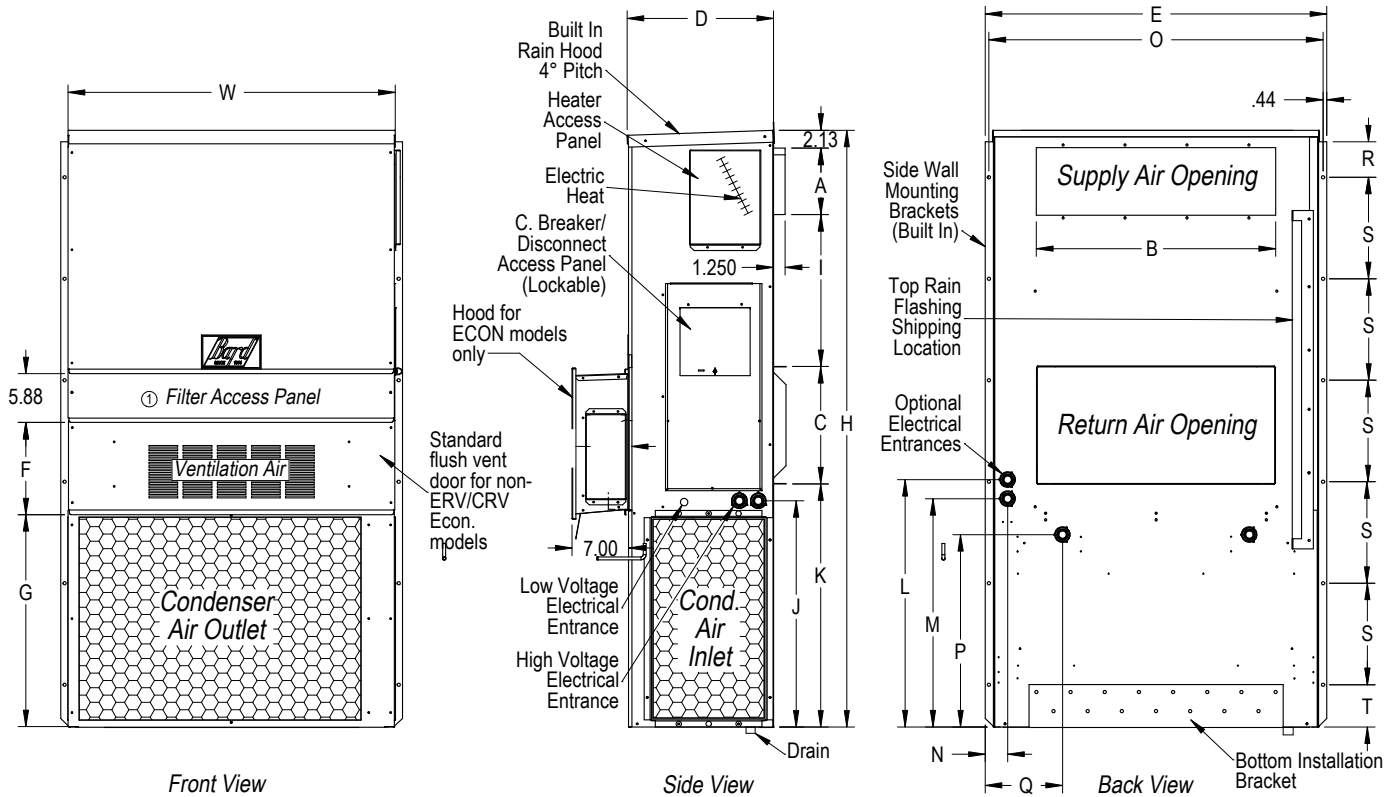

MIS-3796

① Not used when WECO Economizers installed. Filter access is through the WECO hood.

**Clearances - Inches (mm)  
Required for Service Access and  
Adequate Condenser Inlet Airflow**

MODELS	LEFT SIDE	RIGHT SIDE
W24LA, W30LA, W36LA	20" (380)	15" (510)
W42LA, W48LA, W60LB, W72LB	20" (510)	20" (510)

**Minimum Clearances - Inches (mm)  
Required to Combustible Materials**

MODELS ①	SUPPLY AIR DUCT FIRST THREE FEET (1m)	CABINET
W24LA	0"	0"
W30LA, W36LA	1/4" (6.35)	0"
W42LA, W48LA, W60LB, W72LB	1/4" (6.35)	0"

① Refer to the Installation Manual for more detailed information.

**Dimensions of Basic Unit for Architectural & Installation Requirements - Inches (mm)**

MODEL	WIDTH (W)	DEPTH (D)	HEIGHT (H)	SUPPLY		RETURN																
				A	B	C	B	E	F	G	I	J	K	L	M	N	O	P	Q	R	S	T
W24LA	33.300 (845)	17.125 (435)	74.563 (1894)	7.88 (200)	19.88 (505)	11.88 (302)	19.88 (505)	35.00 (889)	10.88 (276)	29.75 (756)	20.56 (522)	30.75 (781)	32.06 (814)	33.25 (845)	31.00 (787)	2.63 (67)	34.13 (867)	26.06 (662)	10.55 (268)	4.19 (106)	12.00 (305)	9.00 (229)
W30LA W36LA	38.200 (970)	17.125 (435)	74.563 (1894)	7.88 (200)	27.88 (708)	13.88 (353)	27.88 (708)	40.00 (1016)	10.88 (276)	29.75 (756)	17.93 (455)	30.75 (781)	32.75 (832)	33.25 (845)	31.00 (787)	2.75 (10)	39.13 (994)	26.75 (679)	9.14 (232)	4.19 (106)	12.00 (305)	9.00 (229)
W42LA W48LA	42.075 (1069)	22.432 (570)	84.875 (2156)	9.88 (251)	29.88 (759)	15.88 (403)	29.88 (759)	43.88 (1115)	13.56 (344)	31.66 (804)	30.00 (762)	32.68 (830)	26.94 (684)	34.69 (881)	32.43 (824)	3.37 (86)	43.00 (1092)	23.88 (607)	10.00 (254)	1.44 (37)	16.00 (406)	1.88 (48)
W60LB W72LB	42.075 (1069)	22.432 (570)	93.000 (2362)	9.88 (251)	29.88 (759)	15.88 (403)	29.88 (759)	43.88 (1115)	13.56 (344)	37.00 (940)	30.00 (762)	40.81 (1037)	35.06 (891)	42.81 (1087)	40.56 (1030)	3.37 (86)	43.00 (1092)	31.00 (787)	10.00 (254)	1.44 (37)	16.00 (406)	10.00 (254)

**W24LA - W72LB Models**

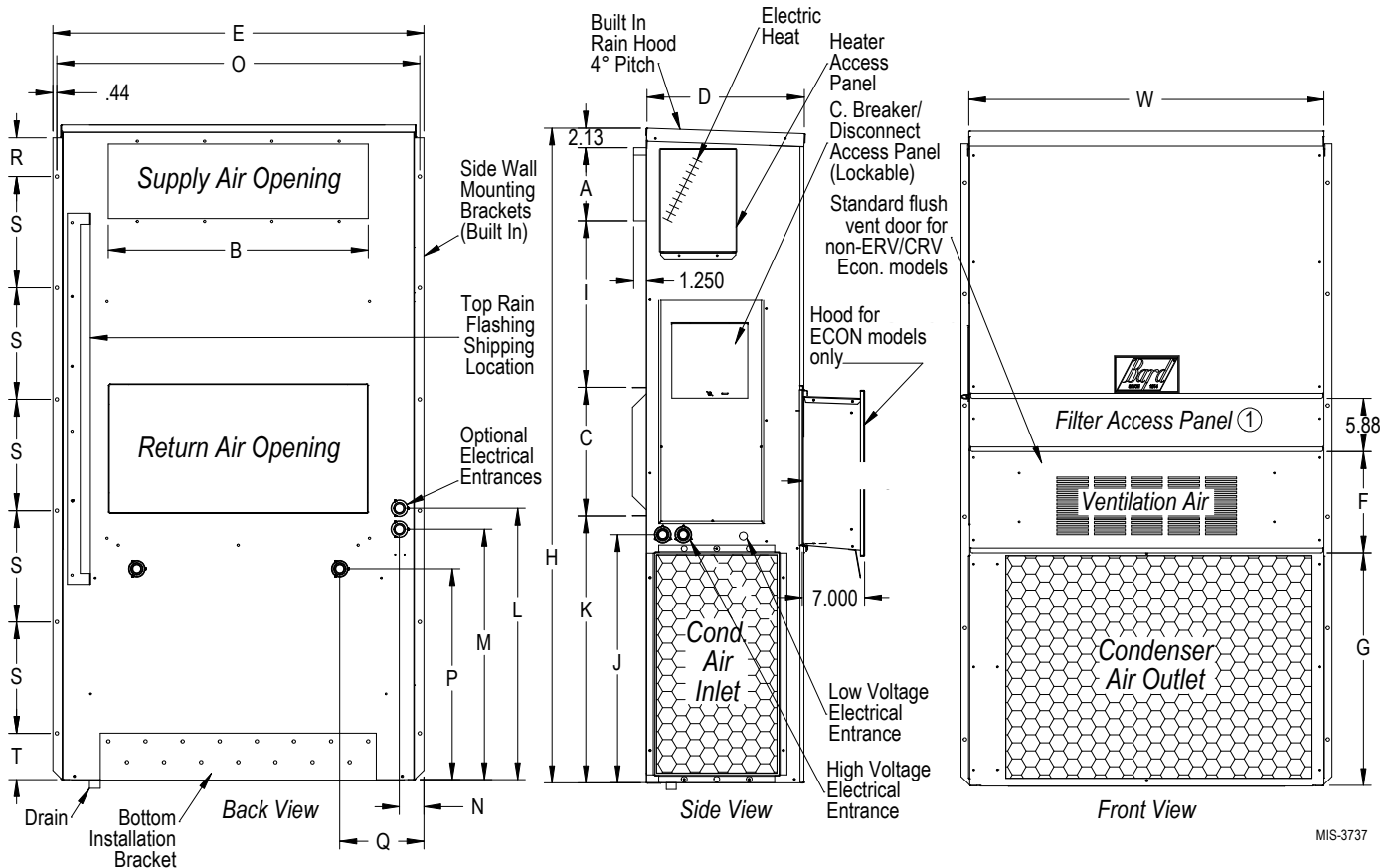

MIS-3737

① Not used when WECO Economizers installed. Filter access is through the WECO hood.

## Electrical Specifications

MODEL	Rated Volts & Phase	Operating Voltage Range	No. Field Power Circuits	② Minimum Circuit Amps	① Maximum External Fuse or Circuit Breaker
W24AA-D0Z D05 D08	240/220-1	198-254	1	16	20
			1	28	30
			1	44	45
W24AA/LA-F0Z F05	415/380-3 ③	342-456	1	9	15
			1	11	15
W30AA-D0Z D05 D10	240/220-1	198-254	1	19	30
			1	29	30
			1	55	60
W30AA-F0Z F07 F12	415/380-3 ③	342-456	1	10	15
			1	17	20
			1	26	30
W36AA-D0Z D05 D10	240/220-1	198-254	1	24	35
			1	29	35
			1	55	60
W36AA-E0Z E06 E12	220/200-3	180-242	1	21	30
			1	21	30
			1	39	40
W36AA/LA-F0Z F07 F12	415/380-3 ③	342-456	1	12	15
			1	17	20
			1	26	30
W42AA-E0Z E09 E15	220/200-3	180-242	1	22	30
			1	31	35
			1	49	50
W42AA/LA-F0Z F07 F14	415/380-3 ③	342-456	1	13	15
			1	17	20
			1	30	30
W48AA-E0Z E09 E15	220/200-3	180-242	1	24	35
			1	31	35
			1	49	50
W48AA-E0Z E09 E15	220/200-3	180-242	1	24	35
			1	31	35
			1	49	50
W48AA/LA-F0Z F07 F14	415/380-3 ③	342-456	1	13	15
			1	17	20
			1	30	30
W60AB-E0Z E09 E15	220/200-3	180-242	1	28	40
			1	35	40
			1	53	60
W60AB/LB-F0Z F07 F14	415/380-3 ③	342-456	1	16	20
			1	18	20
			1	32	35
W72AB/LB-F0Z F07 F14	415/380-3 ③	342-440	1	24	30
			1	24	30
			1	35	35

① Maximum size of the time delay fuse or "D" rated circuit breaker for protection of field wiring conductors.

② These "Minimum Circuit Amp" values are to be used for sizing the field power conductors.

③ 415/380-3 Electrical Ratings are 3-phase wye (star) systems requiring three (3) phase legs plus neutral and ground. **NOTE:** The indoor and outdoor motors and 24V transformer primary are connected at 240V derived from one (1) phase leg to neutral. This is internally connected and no field wiring required.

**NOTE:** All wiring must conform to NIC/EIC latest edition.

**IMPORTANT:** While this electrical data is presented as a guide, it is important to electrically connect properly sized fuses & conductor wires in accordance with the National Electrical Code & all local codes.

## Electric Heat Table - Refer to Electrical Specifications for Availability by Unit Model

Model	W24AA-D		W24AA-F W24LA-F		W30AA-D W36AA-D		W36AA-E		W30AA-F W36AA-F W36LA-F		W42AA-E W48AA-E W60AB-E		W42AA-F, W42LA-F W48AA-F, W48LA-F W60AB-F, W60LB-F W72AB-F, W72LB-F		
	① KW	240V-1 WATTS	220V-1 WATTS	415V-3 WATTS	380V-3 WATTS	240V-1 WATTS	220V-1 WATTS	220V-3 WATTS	200V-3 WATTS	415V-3 WATTS	380V-3 WATTS	220V-3 WATTS	200V-3 WATTS	415V-3 WATTS	380V-3 WATTS
5.0	5000	4201	4883	4095	5000	4201									
8.0	8000	6722													
10.0					10000	8403									
6.0							5042	4167							
7.0									6728	5641				6728	5641
9.0											7562	6250			
12.0							10083	8333	11213	9401					
14.0															
15.0											12604	10417			

① Nominal Heater KW based on unit model number.

## Cooling Application Data - Outdoor Temperature ①② Btuh (KW)

Model	Return Air (DB/WB) ③	Cooling Capacity	75°F (23.9°C)	85°F (29.4°C)	95°F (35.0°C)	105°F (40.6°C)	115°F (46.1°C)	125°F (51.7°C)
W24AA W24LA	75/62°F (23.9/16.7°C)	Total Cooling Sensible Cooling	25400 (7.44) 19900 (5.83)	22200 (6.50) 17900 (5.24)	21900 (6.42) 16500 (4.83)	17700 (5.18) 15500 (4.54)	16200 (4.74) 15000 (4.39)	15200 (4.45) 14500 (4.25)
	80/67°F (26.7/19.4°C)	Total Cooling Sensible Cooling	27100 (7.94) 19300 (5.65)	24600 (7.20) 17700 (5.18)	22400 (6.56) 16600 (4.86)	20800 (6.09) 15900 (4.66)	19400 (5.68) 15500 (4.54)	18400 (5.39) 15500 (4.54)
	85/72°F (29.4/22.2°C)	Total Cooling Sensible Cooling	32300 (9.46) 19800 (5.80)	28300 (8.29) 17800 (5.21)	25000 (7.32) 16200 (4.74)	22400 (6.56) 15000 (4.39)	20400 (5.97) 14200 (4.16)	19000 (5.56) 13800 (4.04)
W30AA W30LA	75/62°F (23.9/16.7°C)	Total Cooling Sensible Cooling	29600 (8.67) 22300 (6.53)	26500 (7.76) 21000 (6.15)	23800 (6.97) 19700 (5.77)	21600 (6.33) 18800 (5.51)	19600 (5.74) 17900 (5.24)	17900 (5.24) 17200 (5.04)
	80/67°F (26.7/19.4°C)	Total Cooling Sensible Cooling	31600 (9.25) 21500 (6.30)	29400 (8.61) 20700 (6.06)	27300 (8.00) 19900 (5.83)	25400 (7.44) 19300 (5.65)	23500 (6.88) 18600 (5.45)	21800 (6.38) 18200 (5.33)
	85/72°F (29.4/22.2°C)	Total Cooling Sensible Cooling	37700 (11.04) 22100 (6.47)	33800 (9.90) 20800 (6.09)	30400 (8.90) 19500 (5.71)	27400 (8.02) 18300 (5.36)	24700 (7.23) 17200 (5.04)	22400 (6.56) 16100 (4.72)
W36AA W36LA	75/62°F (23.9/16.7°C)	Total Cooling Sensible Cooling	36000 (10.54) 26500 (7.76)	32100 (9.40) 24800 (7.26)	28900 (8.46) 23300 (6.82)	26400 (7.73) 22300 (6.53)	24400 (7.15) 21400 (6.27)	23000 (6.74) 20900 (6.12)
	80/67°F (26.7/19.4°C)	Total Cooling Sensible Cooling	38400 (11.25) 25700 (7.53)	35600 (10.43) 24500 (7.18)	33300 (9.73) 23500 (6.88)	31200 (9.14) 22800 (6.68)	29400 (8.61) 22300 (6.53)	28000 (8.20) 22000 (6.44)
	85/72°F (29.4/22.2°C)	Total Cooling Sensible Cooling	45700 (13.38) 26300 (7.70)	40900 (11.98) 24600 (7.20)	36900 (10.81) 23100 (6.77)	33600 (9.84) 21800 (6.38)	30900 (9.05) 20500 (6.00)	28800 (8.43) 19400 (5.68)
W42AA W42LA	75/62°F (23.9/16.7°C)	Total Cooling Sensible Cooling	39700 (11.63) 30900 (9.05)	36200 (10.6) 29400 (8.61)	33000 (9.66) 28200 (8.26)	30000 (8.79) 26900 (7.88)	27200 (7.97) 25600 (7.50)	24500 (7.18) 24300 (7.12)
	80/67°F (26.7/19.4°C)	Total Cooling Sensible Cooling	42400 (12.42) 30000 (8.79)	40200 (11.77) 29200 (8.55)	37800 (11.07) 28400 (8.32)	35400 (10.37) 27500 (8.05)	32600 (9.55) 26600 (7.79)	29800 (8.73) 25600 (7.50)
	85/72°F (29.4/22.2°C)	Total Cooling Sensible Cooling	50500 (14.79) 30700 (8.99)	46200 (13.53) 29400 (8.61)	42000 (12.3) 27900 (8.17)	38200 (11.19) 26300 (7.7)	34300 (10.05) 24500 (7.18)	30700 (8.99) 22700 (6.65)
W48AA W48LA	75/62°F (23.9/16.7°C)	Total Cooling Sensible Cooling	46000 (13.47) 35300 (10.34)	41900 (12.27) 33600 (9.84)	38100 (11.16) 32100 (9.40)	34600 (10.13) 30400 (8.90)	31400 (9.20) 29000 (8.49)	28300 (8.29) 27400 (8.02)
	80/67°F (26.7/19.4°C)	Total Cooling Sensible Cooling	49100 (14.38) 34200 (10.02)	46600 (13.65) 33300 (9.75)	43700 (12.8) 32400 (9.49)	40800 (11.95) 31300 (9.17)	37700 (11.04) 30200 (8.84)	34400 (10.07) 28900 (8.46)
	85/72°F (29.4/22.2°C)	Total Cooling Sensible Cooling	58500 (17.13) 35000 (10.25)	53500 (15.67) 33400 (9.78)	48600 (14.23) 31700 (9.28)	44000 (12.89) 29800 (8.73)	39600 (11.6) 27800 (8.14)	35400 (10.37) 25600 (7.5)
W60AB W60LB	75/62°F (23.9/16.7°C)	Total Cooling Sensible Cooling	59900 (17.54) 45600 (13.36)	53100 (15.55) 42500 (12.45)	46800 (13.71) 39400 (11.54)	41300 (12.10) 36600 (10.72)	36100 (10.57) 34000 (9.96)	31200 (9.14) 32200 (9.43)
	80/67°F (26.7/19.4°C)	Total Cooling Sensible Cooling	63900 (18.71) 44300 (12.97)	58900 (17.25) 42000 (12.30)	50100 (14.68) 39700 (11.63)	48600 (14.23) 37500 (10.98)	43400 (12.71) 35400 (10.37)	38000 (11.13) 33300 (9.75)
	85/72°F (29.4/22.2°C)	Total Cooling Sensible Cooling	76100 (22.29) 45400 (13.3)	67700 (19.83) 42200 (12.36)	59700 (17.48) 39000 (11.42)	52500 (15.38) 35800 (10.48)	45500 (13.33) 32500 (9.52)	39100 (11.45) 29400 (8.61)
W72AB W72LB	75/62°F (23.9/16.7°C)	Total Cooling Sensible Cooling	67200 (19.68) 50600 (14.82)	61700 (18.07) 47700 (13.97)	56300 (16.49) 45100 (13.21)	51100 (14.97) 42500 (12.45)	45900 (13.44) 40300 (11.8)	40800 (11.95) 38300 (11.22)
	80/67°F (26.7/19.4°C)	Total Cooling Sensible Cooling	71800 (21.03) 49100 (14.38)	68600 (20.09) 47300 (13.85)	64700 (18.95) 45500 (13.33)	60300 (17.66) 43600 (12.77)	55300 (16.20) 41900 (12.27)	49700 (14.56) 40300 (11.80)
	85/72°F (29.4/22.2°C)	Total Cooling Sensible Cooling	85500 (25.04) 50300 (14.73)	78800 (23.08) 47500 (13.91)	71800 (21.03) 44600 (13.06)	65000 (19.04) 41600 (12.18)	58100 (17.02) 38600 (11.3)	51200 (15.) 35600 (10.43)

① Below 65°F, unit requires a factory or field installed low ambient control.

② Outdoor temperatures shown are measured at the condenser section air inlet.

③ Return air temperature °F.

### Unit Charge Rates - R410A

UNIT	Std. Unit - Lbs.	Dehum. Units - Lbs.
W24AA/LA - 10 EER Right & Left A/C	4.25	N/A
W30AA/LA - 10 EER Right & Left A/C	3.875	N/A
W36AA/LA - 10 EER Right & Left A/C	4.3125	N/A
W42AA/LA - 10 EER Right & Left A/C	4.8125	N/A
W48AA/LA - 10 EER Right & Left A/C	6.375	N/A
W60AB/LB - 10 EER Right & Left A/C	7.3125	N/A
W72AB/LB - 10 EER Right & Left A/C	8.8125	N/A

# Indoor Blower Performance - CFM (m<sup>3</sup>/s) at 220 Volts

Speed	W24		W30		W36		W42		W48		W60		W72															
	Single ①		High ①		Low		High		Low		High ①		Medium ①															
	Dry Coil	Wet Coil	Dry Coil	Wet Coil	Dry Coil	Wet Coil	Dry Coil	Wet Coil	Dry Coil	Wet Coil	Dry Coil	Wet Coil	Dry Coil	Wet Coil	Low													
ESP (Inch H <sub>2</sub> O) (Pa)																												
0.0 (0)	840 (0.4)	810 (0.38)	1200 (0.57)	1145 (0.54)	780 (0.37)	770 (0.36)	1160 (0.55)	1085 (0.51)	800 (0.38)	795 (0.38)	1645 (0.78)	1610 (0.76)	1495 (0.71)	1415 (0.67)	1660 (0.78)	1610 (0.76)	1455 (0.69)	1410 (0.67)	1745 (0.82)	1670 (0.79)	1280 (0.60)	1210 (0.57)	1870 (0.88)	1790 (0.84)	1720 (0.81)	1670 (0.79)	1655 (0.78)	1600 (0.76)
0.1 (25)	795 (0.38)	770 (0.36)	1150 (0.54)	1095 (0.52)	770 (0.36)	765 (0.36)	1110 (0.52)	1045 (0.49)	780 (0.37)	770 (0.36)	1580 (0.75)	1560 (0.74)	1410 (0.67)	1360 (0.64)	1585 (0.75)	1550 (0.73)	1390 (0.66)	1340 (0.63)	1695 (0.80)	1625 (0.77)	1230 (0.58)	1160 (0.55)	1815 (0.86)	1740 (0.82)	1670 (0.79)	1630 (0.77)	1620 (0.76)	1550 (0.73)
0.2 (50)	750 (0.35)	720 (0.34)	1085 (0.51)	1030 (0.49)	765 (0.36)	755 (0.36)	1050 (0.50)	985 (0.46)	750 (0.35)	740 (0.35)	1510 (0.71)	1460 (0.69)	1340 (0.63)	1300 (0.61)	1510 (0.71)	1470 (0.69)	1330 (0.63)	1280 (0.60)	1635 (0.77)	1565 (0.74)	1160 (0.55)	1090 (0.51)	1755 (0.83)	1690 (0.80)	1625 (0.77)	1590 (0.75)	1565 (0.74)	1515 (0.72)
0.3 (75)	695 (0.33)	665 (0.31)	1015 (0.48)	955 (0.45)	745 (0.35)	730 (0.34)	980 (0.46)	915 (0.43)	715 (0.34)	705 (0.33)	1440 (0.68)	1380 (0.65)	1270 (0.60)	1205 (0.57)	1430 (0.67)	1330 (0.63)	1245 (0.59)	1185 (0.56)	1575 (0.74)	1495 (0.71)	1080 (0.51)	1015 (0.48)	1700 (0.80)	1635 (0.77)	1590 (0.75)	1550 (0.73)	1525 (0.72)	1480 (0.70)
0.4 (100)	625 (0.29)	600 (0.28)	935 (0.44)	875 (0.41)	705 (0.33)	690 (0.33)	895 (0.42)	840 (0.40)	665 (0.31)	650 (0.31)	1340 (0.63)	1300 (0.61)	1185 (0.56)	1120 (0.53)	1305 (0.62)	1245 (0.59)	1140 (0.54)	1095 (0.52)	1495 (0.71)	1410 (0.67)	1015 (0.48)	955 (0.45)	1650 (0.78)	1595 (0.75)	1545 (0.73)	1505 (0.71)	1475 (0.70)	1430 (0.67)
0.5 (125)	530 (0.25)	505 (0.24)	845 (0.4)	790 (0.37)	650 (0.31)	625 (0.29)	805 (0.38)	745 (0.35)	585 (0.28)	565 (0.27)	1255 (0.59)	1145 (0.54)	915 (0.43)	830 (0.39)	1180 (0.56)	990 (0.47)	890 (0.42)	855 (0.40)	1415 (0.67)	1330 (0.63)	920 (0.43)	890 (0.42)	1600 (0.76)	1540 (0.73)	1500 (0.71)	1465 (0.69)	1430 (0.67)	1340 (0.63)

Above data is with 1" (25mm) standard disposable filter and 1" (25mm) washable filter.  
 For optional 2" (51mm) pleated filter - reduce ESP by .15" (37.33Pa).  
 See installation instructions for maximum ESP information on various KW application.

Speeds marked "bold" above are **Factory Connected**.



# Air Conditioning Wall-Mount Model Nomenclature

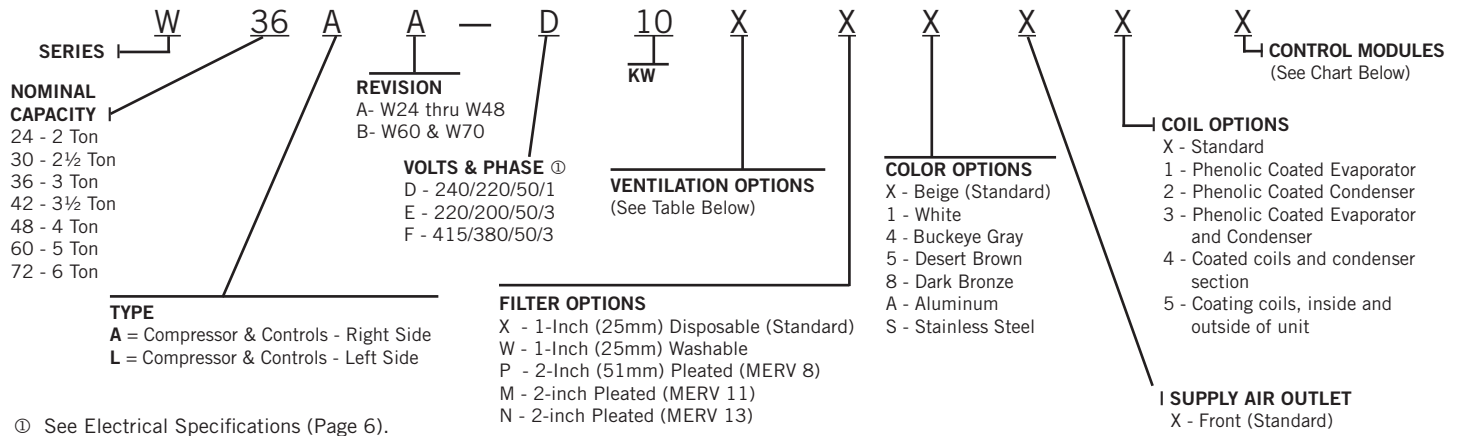

① See Electrical Specifications (Page 6).

## Ventilation Options

Models	W18AA, W24AA W18LA, W24LA		W30AA, W36AA W30LA, W36LA		W42AA, W48AA, W60AB W42LA, W48LA, W60LB		W72AB W72LB	
	Factory Inst. Code No.	Field Inst. Part No.	Factory Inst. Code No.	Field Inst. Part No.	Factory Inst. Code No.	Field Inst. Part No.	Factory Inst. Code No.	Field Inst. Part No.
Barometric Fresh Air Damper - Standard	X	BFAD-2	X	BFAD-3	X	BFAD-5	X	BFAD-5
Blank-Off Plate	B	BOP-2	B	BOP-3	B	BOP-5	B	BOP-5
Motorized Fresh Air Damper w/Plug	M	WMFADP2	M	WMFADP3	M	WMFADP5	M	WMFADP5
Commercial Ventilator - Spring Return	C	WCRVPS2P-* ④	C	WCRVPS3P-* ④	C	WCRVPS5P-* ④	C	WCRVPS6P-* ④
Economizer w/Plug, Temp Only ③	Y	WECOPT2-* ②	Y	WECOPT3-* ②	Y	WECOPT5-* ②	Y	WECOPT5-* ②
Economizer w/Plug, Enthalpy ③	Z	WECOPE2-* ②	Z	WECOPE3-* ②	Z	WECOPE5-* ②	Z	WECOPE5-* ②

- ① Intake and exhaust can be independently adjusted.
- ② Insert color to match unit ("X" = Beige; "4" = Buckeye Gray; etc.)
- ③ All Economizer versions have 7" deep intake hood.
- ④ Commercial Ventilator does not have 7" deep intake hood.

## Air Conditioning Control Modules

Air Conditioning Control Modules									All Models Except As Noted	
HPC ①	LPC ②	CCM ③	LAC ④	ALR ⑤	SK ⑥	SK ⑦	ODT ⑧	DDC ⑨	Factory Installed Code	Field Installed Part
STD	STD	STD							X	N/A
STD	STD	STD	•						E	CMA-28
STD	STD	STD	•	•					J	Factory Only
STD	STD	STD	•		•				K	CMC-15 and CMA-28
STD	STD	STD	•	•	•				M	Factory Only
STD	STD	STD			•				Field Installed Only	CMC-15
STD	STD	STD					•		Field Installed Only	CMA-14
STD	STD	STD	•	•				•	V ⑩	Factory Only
STD	STD	STD						•	Field Installed Only	CMA-31 for W18-36 CMA-30 for W42-72
STD	STD	STD				•			Field Installed Only	SK111 Except W60 & 72 SK121 W72 Only SK122 W60 Only

STD = Standard equipment for these specified models.

- ① HPC. High pressure control is auto reset. Always used with compressor control module (CCM) which is included. See note ③.
- ② LPC. Low pressure control is auto reset. Always used with compressor control module (CCM) which is included. See note ③.
- ③ CCM. Compressor control module has adjustable 30-second to 5-minute delay-on-break timer. On initial power-up, or any time the power is interrupted, the delay-on-make will be 2-minutes plus 10% of the delay-on-break setting. There is no delay-on-make during routine operation of the unit. The module also provides the lockout feature (with 1 retry) for high and/or low pressure controls, and a 2-minute timed bypass for low-pressure control.
- ④ LAC. Low ambient control permits cooling operation down to 0°F. LAC is fan-cycling control for outdoor fan motor on all models except W24 units, which have modulating control.
- ⑤ ALR. The alarm relay has a set of normally open and normally closed dry contacts to provide the ability to signal a condition of shutdown on either high or low pressure controls.
- ⑥ SK. PTGR start kit can be used with all -D single phase models. Increases starting torque 2-3x. Used for -D models only (single-phase). Do not use if SK111 or SK121 is used.
- ⑦ SK. Start capacitor & potential relay start kit can be used with all -D single phase models. Increases starting torque 9x. Used for -D models only (single-phase). Do not use if CMC-15 is used.
- ⑧ ODT. Outdoor thermostat is adjustable from 0 to 50°F. It is suitable for use as a compressor cut-off thermostat.
- ⑨ DDC. Incorporates 4 additional sensors: discharge air temperature, indoor blower airflow, compressor current, and dirty filter. These sensing devices function to input analog data such as temperature, as well as digital data such as airflow, compressor status or filter status. Special economizer required; consult factory.
- ⑩ "V" control module for use with field-supplied DDC. Refer to "V" Module document F1605 for more information.



Bard Manufacturing Company, Inc.  
Bryan, Ohio 43506  
www.bardhvac.com

**Due to our continuous product improvement policy, all specifications subject to change without notice.**

Before purchasing this appliance, read important energy cost and efficiency information available from your retailer.

**Form No.  
S3524  
October 2018**

Supersedes: S3524-318